



AgEcon SEARCH
RESEARCH IN AGRICULTURAL & APPLIED ECONOMICS

The World's Largest Open Access Agricultural & Applied Economics Digital Library

This document is discoverable and free to researchers across the globe due to the work of AgEcon Search.

Help ensure our sustainability.

Give to AgEcon Search

AgEcon Search

<http://ageconsearch.umn.edu>

aesearch@umn.edu

*Papers downloaded from **AgEcon Search** may be used for non-commercial purposes and personal study only. No other use, including posting to another Internet site, is permitted without permission from the copyright owner (not AgEcon Search), or as allowed under the provisions of Fair Use, U.S. Copyright Act, Title 17 U.S.C.*

**Integrated Report of the Project
“Identification of Pulling Factors
for Enhancing the Sustainable
Development of Diverse Agriculture
in Selected Asian Countries”**

**Tomohide Sugino
Hitoshi Yonekura
Parulian Hutagaol**



ESCAP is the regional development arm of the United Nations and serves as the main economic and social development centre for the United Nations in Asia and the Pacific. Its mandate is to foster co-operation between its 53 members and nine associate members. ESCAP provides the strategic link between global and country-level programmes and issues. It supports Governments of the region in consolidating regional positions and advocates regional approaches to meeting the region's unique socio-economic challenges in a globalizing world. The ESCAP office is located in Bangkok, Thailand. Please visit our website at <www.unescap.org> for further information.

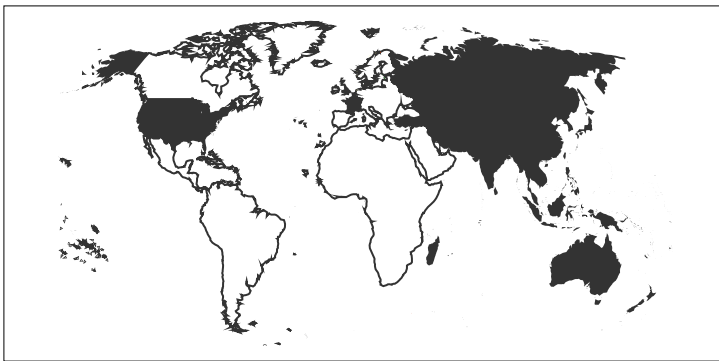

The shaded areas of the map indicate ESCAP members and associate members.

UNESCAP-CAPSA

The Centre for Alleviation of Poverty through Secondary Crops' Development in Asia and the Pacific (CAPSA) is a subsidiary body of UNESCAP. It was established as the Regional Co-ordination Centre for Research and Development of Coarse Grains, Pulses, Roots and Tuber Crops in the Humid Tropics of Asia and the Pacific (CGPRT Centre) in 1981 and was renamed CAPSA in 2004.

Objectives

CAPSA promotes a more supportive policy environment in member countries to enhance the living conditions of rural poor populations in disadvantaged areas, particularly those who rely on secondary crop agriculture for their livelihood, and to promote research and development related to agriculture to alleviate poverty in the Asian and Pacific region.

CAPSA Working Paper No. 99

**Integrated Report of the Project
“Identification of Pulling Factors
for Enhancing the Sustainable
Development of Diverse Agriculture
in Selected Asian Countries”**

**Tomohide Sugino
Hitoshi Yonekura
Parulian Hutagaol**



United Nations
New York, 2006

ECONOMIC AND SOCIAL COMMISSION FOR ASIA AND THE PACIFIC

UNESCAP-CAPSA
Jalan Merdeka 145, Bogor 16111
Indonesia
© 2006 by the UNESCAP-CAPSA
All rights reserved. Published 2006
Printed in Indonesia

Cover Photograph by Tomohide Sugino

National Library: Cataloguing in Publication

Sugino, Tomohide
Integrated Report of the Project "Identification of Pulling Factors for Enhancing
the Sustainable Development of Diverse Agriculture in Selected Asian
Countries" / Tomohide Sugino, Hitoshi Yonekura, Parulian Hutagaol. -- Bogor:
UNESCAP-CAPSA, 2006.
xx, 137 pp.; 23.8 cm. -- (Working paper series; No. 99).

ISBN 979-9317-60-6

1. Agriculture -- Research -- Asia.

I. Title. II. Yonekura, Hitoshi.

III. Hutagaol, Parulian. IV. Series.

630.709 5

The designations employed and the presentation of material in this publication do not imply the expression of any opinion whatsoever on the part of the Secretariat of the United Nations concerning the legal status of any country, territory, city or area of its authorities, or concerning the delimitation of its frontiers or boundaries.

The opinions expressed in signed articles are those of the authors and do not necessarily represent the opinion of the United Nations.

Table of Contents

	Page
List of Tables	vii
List of Figures	ix
List of Boxes	xi
Foreword	xiii
Acknowledgements	xv
Executive Summary	xvii
1. Introduction	
1.1 Position of the project	1
1.2 Background of the project.....	1
1.3 Objectives and expected outcomes.....	4
1.4 Analytical framework and study subjects	5
1.5 Record of project implementation	8
1.6 List of publications	14
1.7 Organization of the integrated report	16
2. General Concepts of Agricultural Diversification	
2.1 Introduction	17
2.2 Meaning of agricultural diversification.....	18
2.3 Fitting the concept of agricultural diversification to the alleviation of rural poverty.....	21
2.4 Mobilizing government support for successful agricultural diversification .	24
2.4.1 Basic public policies	25
2.4.2 Enabling public policies.	28
2.5 Closing remarks	31
3. Socio-economic Characteristics and the Agricultural Structure of the Participating Countries	
3.1 Population	33
3.2 Economic structure.....	34
3.3 Trade structure	35

3.4	Poverty	35
3.5	Land use	41
3.6	Concluding summary	41
4.	Historical and Current Status of Secondary Crops and Agricultural Diversification	
4.1	Trends in area, production and yield of secondary crops	43
4.1.1	Trends of secondary crop production and consumption in the region	44
4.2	Cost and revenue of secondary crops	60
4.3	Comparative advantage of secondary crops	65
4.3.1	Maize	65
4.3.2	Soybean	65
4.3.3	Potato	66
4.4	Trends of agricultural diversification	68
4.4.1	Simpson Index (SID) of crop groups by harvested area	68
4.4.2	SID trend	69
4.5	Impact of diversified agricultural systems on the environment in the region	70
4.5.1	The impact of intensified agriculture on environmental degradation	70
4.5.2	Role of agricultural diversification in overcoming environmental deterioration	71
4.5.3	Valuation method for the environment	72
4.5.4	Impact on agro-biodiversity	72
4.6	Concluding summary	73
5.	Prospects of Industrial Uses of Secondary Crops	
5.1	Trends of secondary crop food processing in the region	76
5.1.1	Maize oil	76
5.1.2	Soybean oil	76
5.1.3	Beer from barley	77
5.2	Industrial importance of secondary crops	77
5.2.1	Biodegradable plastics	78
5.2.2	Renewable energy (biofuel)	79
5.3	Concluding summary	90

6.	Prioritization of Research and Development for Sustainable and Diversified Agriculture	
6.1	Introduction	93
6.2	Methodology	94
6.2.1	Structure of the questionnaire	94
6.3	Results	97
6.3.1	Profiles of respondents	97
6.3.2	Priority of R&D topics	97
6.3.3	Expected effects of the R&D topics	98
6.3.4	Effective measures to implement the research topics	102
6.4	Discussion	102
6.5	Concluding summary	105
7.	Utilizing Secondary Crops for Development and Poverty Alleviation under Globalization	
7.1	Diversification in the study countries	107
7.1.1	Mode of diversification and specialization	107
7.1.2	Prospects of industrial uses	110
7.2	Framework of AGRIDIV.....	111
7.2.1	When the secondary crops (CGPRT crops) become important?	111
7.2.2	Why diversification of secondary crops?	112
7.2.3	Who should explore and utilizes the opportunities of secondary crops?	114
7.2.4	What are the conditions necessary to enhance the private sector?	114
7.2.5	How to promote effective use of secondary crops?	115
7.3	Development strategy of secondary crop based economy	115
7.3.1	New demand dimension	115
7.3.2	Essential conditions	116
7.3.3	Role sharing between market and government	116
7.3.4	Role of local government	117
7.4	Market, price and inter-country co-ordination	118
7.4.1	Activating and accelerating the role of local markets	118

7.4.2	Mitigating price and production risks for the poor	118
7.4.3	Mitigating foreign exchange impacts and other macroeconomic risks	119
7.4.4	Establishing international platform for co-ordination	119
7.5	Conclusions	121
8.	Policy Recommendations and Conclusions	
8.1	Technological development	123
8.2	Marketing.....	125
8.3	Infrastructure and information.....	127
8.4	Credit	128
8.5	Processing	129
8.6	Price and trade policy	131
8.7	Input	132
8.8	Regional co-operation	134
8.9	Farmer groups	134
8.10	Land policy	135
8.11	Overall conclusion and recommendations	135

List of Tables

	Page
Chapter 3	
Table 3.1	Population profile of the participating countries 34
Table 3.2	Income, GDP and employment structure of the participating countries ... 36
Table 3.3	Structure of goods exports in the participating countries 37
Table 3.4	Structure of goods imports in the participating countries 38
Table 3.5	Unemployment and poverty in the participating countries 39
Table 3.6	Land use in the participating countries 40
Chapter 4	
Table 4.1	Cost and revenue of coarse grain production in the participating countries 61
Table 4.2	Cost and revenue of pulse production in the participating countries 63
Table 4.3	Cost and revenue of roots and tuber crop production in the participating countries 64
Table 4.4	Cost and revenue of rice production in the participating countries 64
Table 4.5	DRCR of secondary crops in the AGRIDIV countries (coarse grains) 66
Table 4.6	DRCR of secondary crops in the AGRIDIV countries (pulses) 67
Table 4.7	DRCR of secondary crops in the AGRIDIV countries (root and tuber) 67
Table 4.8	Recent trend of SID in selected years 69
Chapter 5	
Table 5.1	Theoretical yield per dry ton of biomass feedstocks 83
Table 5.2	Necessary increase in crop production for biofuel production 85
Chapter 6	
Table 6.1	Constraints to agricultural diversification 94
Table 6.2	Items included in the questionnaire 95
Table 6.3	R&D topics surveyed 96
Table 6.4	Profession of respondents 97
Table 6.5	Place of work of the respondents 97
Table 6.6	Importance Index (I-Index) of the 15 R&D topics 99
Table 6.7	Expected effects and measures to achieve them 100

Chapter 7

Table 7.1	Diversification Mode A	108
Table 7.2	Diversification Mode B	108
Table 7.3	Diversification Mode C	108
Table 7.4	Domestic Resource Cost (DRC) by Country	120

List of Figures

	Page
Chapter 1	
Figure 1.1 Roadmap to AGRIDIV	6
Figure 1.2 Participating countries of the AGRIDIV project	10
Chapter 4	
Figure 4.1 Harvested area of total coarse grains	44
Figure 4.2 Production of total coarse grains	44
Figure 4.3 Yield of total coarse grains	45
Figure 4.4 Total harvested area of maize in Asia and the Pacific	45
Figure 4.5 Total production of maize in Asia and the Pacific	46
Figure 4.6 Average yield of maize in Asia and the Pacific	46
Figure 4.7 Harvested area of total pulses	47
Figure 4.8 Production of total pulses	47
Figure 4.9 Yield of total pulses	48
Figure 4.10 Total harvested area of soybean in Asia and the Pacific	48
Figure 4.11 Production of soybean in Asia and the Pacific	49
Figure 4.12 Average yield of soybean in Asia and the Pacific	49
Figure 4.13 Total harvested area of groundnut in Asia and the Pacific	50
Figure 4.14 Total production of groundnut in Asia and the Pacific	50
Figure 4.15 Average yield of groundnut in Asia and the Pacific	51
Figure 4.16 Harvested area of total roots and tubers	52
Figure 4.17 Production of total roots and tubers	52
Figure 4.18 Yield of total roots and tubers	53
Figure 4.19 Total harvested area of cassava in Asia and the Pacific	53
Figure 4.20 Total production of cassava in Asia and the Pacific	54
Figure 4.21 Average yield of cassava in Asia and the Pacific	54
Figure 4.22 Total harvested area of potato in Asia and the Pacific	55
Figure 4.23 Total production of potato in Asia and the Pacific	55
Figure 4.24 Average yield of potato in Asia and the Pacific	56
Figure 4.25 Total harvested area of sweet potato in Asia and the Pacific	56
Figure 4.26 Total production of sweet potato in Asia and the Pacific	57

Figure 4.27	Average yield of sweet potato in Asia and the Pacific	57
Figure 4.28	Total consumption of maize in Asia and the Pacific	58
Figure 4.29	Total consumption of soybean in Asia and the Pacific	58
Figure 4.30	Total consumption of groundnut in Asia and the Pacific	59
Figure 4.31	Total consumption of cassava in Asia and the Pacific	59
Figure 4.32	Total consumption of potato in Asia and the Pacific	60
Figure 4.33	Total consumption of sweet potato in Asia and the Pacific	60
Figure 4.34	Most commonly used environmental valuation methods	72
 Chapter 5		
Figure 5.1	Ratio of secondary crop consumption as food in Asia and the Pacific	75
Figure 5.2	Production of maize oil	76
Figure 5.3	Production of soybean oil	77
Figure 5.4	Production of beer from barley	77
Figure 5.5	Life cycle of biodegradable plastics; the case of PLA	78
Figure 5.6	Alcohol fuel consumption in USA	81
Figure 5.7	Ratio of alcohol fuel to gasoline consumption in USA	82
Figure 5.8	Ratio of biodiesel to conventional diesel consumption in USA	82
Figure 5.9	Maize production in Asia and the Pacific	84
Figure 5.10	Correlation between gasoline price and alcohol fuel consumption	88
 Chapter 6		
Figure 6.1	Number of countries where 80 per cent or more of the respondents expected poverty to be alleviated by the R&D topics offered	102
Figure 6.2	Classification of the surveyed R&D topics	104

List of Boxes

	Page
Chapter 1	
Box 1.1 Study subjects by study phase	7
Chapter 8	
Box 8.1 Summary of recommendations (Technology development)	125
Box 8.2 Summary of recommendations (Marketing)	126
Box 8.3 Summary of recommendations (Infrastructure and information)	127
Box 8.4 Summary of recommendations (Credit)	129
Box 8.5 Summary of recommendations (Processing)	130
Box 8.6 Summary of recommendations (Price and trade)	132
Box 8.7 Summary of recommendations (Inputs)	133
Box 8.8 Summary of recommendations (Regional co-operation)	134
Box 8.9 Summary of recommendations (Farmer groups)	135
Box 8.10 Summary of recommendations (Land policy)	135

Foreword

The three-year research project “Identification of Pulling Factors for Enhancing Sustainable Development of Diverse Agriculture in Selected Asian Countries (AGRIDIV)” was implemented in collaboration with eight countries, Bangladesh, India, Indonesia, Lao People’s Democratic Republic, Myanmar, Sri Lanka, Thailand and Viet Nam during 2003 to 2006.

Though current policies, which favour rice and wheat, have succeeded in multiplying major cereal production, the darker side of these strategies have triggered stagnation in rice yield, scarcity of irrigation water, environmental impacts of intensive cropping and the continuation of chronic poverty in rural society. These matters have lead policy planners to pay more attention to agricultural diversification.

The regional and country studies of the project have already produced sixteen volumes of country study reports, two (Phase I and II) from each of the eight countries, and one volume of the proceedings of an international workshop which was held in December 2005 in Bogor, Indonesia.

It is my pleasure to publish this integrated report as the final product of the project. It compiles major findings of the studies and provides recommendations for the further formation of relevant and practical policies will alleviate poverty through agricultural diversification.

I am most grateful to Prof. Hitoshi Yonekura, Tohoku University, Japan, for his devoted services as the Regional Advisor of the project. I highly appreciate Mr. Tomohide Sugino, Japan International Research Center for Agricultural Sciences, Japan and Dr. Parulian Hutagaol, Bogor Agricultural University, Indonesia as Project Leader and Associate Project Leader respectively. They designed essential parts of the project and co-ordinated the research team. My appreciation also extends to Mr. Matthew L. Burrows and CAPSA staff for preparing the work for publishing.

Finally, I would like to express my sincere appreciation to the Government of Japan for its generous support in funding this project.

October 2006

Taco Bottema
Director
UNESCAP-CAPSA

Acknowledgements

We would like to express our sincere gratitude to the research team members of the eight participating countries of the AGRIDIV project, namely, Dr. Jahangir Alam Khan, Bangladesh, Dr. Ram Pyare Singh, India, Mr. Masdjidin Siregar, Indonesia, Mr. Linkham Douangsavanh, Lao People's Democratic Republic, Mr. Aung Kyi, Myanmar, Mr. Abdul Rahim Mohamed Mahrouf, Sri Lanka, Ms. Nareenat Roonnapai, Thailand and Dr. Dao The Anh, Viet Nam. Without their earnest and tireless efforts to conduct country studies, the project could not have been completed.

Our acknowledgements are extended to Dr. Taco Bottema, Director of UNESCAP-CAPSA and Dr. Nobuyoshi Maeno, former Director of UNESCAP-CAPSA, for their continuous support of our activities.

We wish to express our thanks to the support staff of UNESCAP-CAPSA, especially Mr. Matthew L. Burrows for English editing and Ms. Francisca Wijaya for secretarial assistance. Last, but not least, we are equally thankful to all those who have helped directly or indirectly enable us to produce this report.

Tomohide Sugino, Project Leader, AGRIDIV project
Parulian Hutagaol, Associate Project Leader, AGRIDIV project
Hitoshi Yonekura, Regional Advisor, AGRIDIV project

Executive Summary

CAPSA implemented a three-year research project, "Identification of Pulling Factors for Enhancing Sustainable Development of Diverse Agriculture in Selected Asian Countries (AGRIDIV)" from April 2003 to March 2006, funded by the Japanese government. The principal objective of the project is to investigate socio-economic impacts of recent development in the regional and global economic environment, including trade liberalization on upland agriculture at the village level and identify constraints to the sustainable development of diversified agriculture, in particular upland agriculture based on secondary crops in the Asian region.

The eight participating countries, namely, Bangladesh, India, Indonesia, Lao People's Democratic Republic, Myanmar, Sri Lanka, Thailand and Viet Nam encompass a lot of diversity in their demographic character, economic structure, trade structure, land use and locality as well as conditions of poverty. For example, Bangladesh is the most densely populated country with forty times the population density of Lao People's Democratic Republic. Although it appears that the industrial sector is a major driving force of the national economy in most countries, agriculture is still important in terms of employment. The status of agriculture in trade has become minor both in exports and imports except in Myanmar, where food and agricultural raw materials shared nearly 90 per cent of total exports in 1990. Bangladesh, India and Lao People's Democratic Republic still have more or less 30 per cent of their respective population below the international poverty line and poverty remains a serious problem in all the countries if national poverty lines are applied.

Vertical agricultural diversification through the development of secondary food crop agriculture has great potential to alleviate rural poverty in developing countries. Its potential will become enhanced when vertical and horizontal agricultural diversification are combined. This requires close co-operation between poor farmers specializing in on-farm production and the processing industry. Such co-operation can only be successful in alleviating poverty from rural areas if the government provides strong support through the provision of a set of appropriate public policies. They include: (i) food diversification; (ii) promoting the development of secondary food crops based processing industry; (iii) infrastructure development; (iv) farm technology and extension services; (v) farm credit; (vi) land tenancy; and (vii) agribusiness partnerships.

Though the harvested area of most secondary crops in Asia and the Pacific is stable or shrinking, production is on the rise due to the steady improvement in yield. The consumption of maize, soybean, groundnut, cassava and potato is growing. The major factor promoting consumption is feed (maize, cassava), food manufacture (soybean, groundnut) and direct consumption as food (groundnut, potato). The marginal revenue increase per rise in costs for secondary crops is better than rice, which can be used to support the idea of promotion of secondary crop production. Many areas have comparative advantage in a specific production, while other areas show less competitiveness. The most remarkable increase of SID (Simpson Index), which is an index to quantify the degree of horizontal diversification, was seen in Lao People's Democratic Republic, while the SID of Bangladesh was stable with small fluctuations.

Direct consumption of secondary crops as food has fallen continuously for the last two decades, however, the production of secondary crops is still expanding due to increases in the use as raw materials for industry. As for 'traditional' processing, production of maize oil, soybean oil and beer from barley is increasing. In terms of 'modern' processing, biodegradable plastics have the potential to substitute 30 per cent of total world plastics production. Asia and the Pacific need to boost maize production by 4.8 per cent if the 2 per cent gasoline consumption is substituted by alcohol, which is equivalent to the current ratio of ethanol use in USA. The growth in demand for secondary crops induced by modern processing will provide opportunities to secondary crop farmers. To realize poverty alleviation through exploiting this opportunity, policy support should be carefully designed since the previous booms of some crops have not necessarily succeeded in improving the welfare of the rural poor.

There are various technology development needs in developing regions. If we consider the limited resources which can be allocated to R&D activities, prioritization of technology development should have an important role in the policy planning process. The results of the questionnaire survey have shown that pest tolerant varieties received the highest priority followed by 'economical soil improvement'. Among all the respondents in the eight countries, 80 per cent or more answered they expect poverty alleviation to be achieved through the technology development of 'intercropping technology' and 'pest tolerant varieties'. It should be noted that the results of the survey indicate a rough direction of technology development. Therefore, it is necessary to conduct further analysis using a participatory approach to identify specific research topics which meet the practical needs of the end users of developed technologies.

Strategic ways to utilize secondary crops for poverty alleviation in the sample countries are;

- Secondary crop farmers are predominantly poor and live in remote or marginal areas in Asia. They are, thus, a vital avenue to alleviate poverty. Without proper utilization of secondary crops, poverty alleviation in developing Asia is difficult to realize. In Asia, further diversification of agriculture would result in extending secondary crop use. Secondary crops can support poor people to cope with rapid economic development and globalization and to raise their income by effectively utilizing many opportunities.
- New industrial uses, in particular for biofuel, are increasing and have large potential.
- To improve the market and its mechanisms, the government should play its role as a facilitator in the market system not a player. The government should limit its role to maintaining the market system, working well and supporting local businesses and farming. Governmental support of, for example, improving market infrastructure, providing market information and others can provide good incentives to accelerate local people utilizing secondary crops. At least from a supply side point of view, the development of secondary crop production should be enhanced by improving the accessibility of the poor to markets. If proper conditions are maintained, even poor people can effectively respond to demand from the market.
- Under globalization, individual countries endeavour to increase their exports of commodities which have competitiveness in an overseas market. Through competition in the overseas markets, individual countries need to respond strategically to market conditions. It is also necessary to examine other profitable and exportable crops. Policy co-ordination for proper resource use among Asian member countries would be fruitful. Creating a platform to communicate among one another, the countries could be effective in reallocating resources beyond national boundaries and promoting proper resource use in the region.

As a conclusion, criteria for designing and implementing policy measurements, as well as development actions which contribute to poverty alleviation through secondary crop based agricultural diversification are proposed.

- Technology development for secondary crops should be strengthened. The allocation of R&D resources should be examined based on the effect of the developed technologies on the welfare of rural poor farmers. Development of cost saving technologies should be prioritized.

- Contract farming is an effective tool to provide mutual benefits to both producers and consumers. Clear and fair contract standards and a workable monitoring system should be provided by the stakeholders.
- Construction of small-scale irrigation, storage facilities and the provision of market information should be prioritized in infrastructure development.
- Credit schemes should focus on resource poor farmers. Practical measures such as grouping credit recipients is necessary to assure repayment.
- Small-scale processing is an effective measure to mitigate rural poverty and should be supported by credit and appropriate processing technologies. Modern processing has the potential to expand secondary crop demand which should be monitored carefully to exploit any opportunities for poverty alleviation.
- Current price support and import trade policies for major cereals should be carefully examined for their impacts on the welfare of poor people.
- The input use for secondary crop production is still low. Therefore, the expected output increase from greater input use is relatively higher than major cereals. It is useful to evaluate the benefit of input use to convince the relevancy of input subsidy schemes.
- There is enough plausibility to formulate regional collaboration schemes to ensure mutual benefits based on differences in socio-economic conditions.
- Farmer groups should be supported to solve the problems that small-scale farmers cannot handle individually, especially to promote contract farming and technology dissemination.
- Strengthening ownership and user land rights should be secured to motivate farmer to invest in their own land.
- During the in-country seminars conducted between January and March 2006 in all participating countries, CAPSA was requested to plan follow-up programmes based on the outputs of AGRIDIV. The potential areas would be implications of bioenergy use in poverty alleviation, impacts of technological development for secondary crops and training policy planners to formulate pro-poor secondary crop development policies.

1. Introduction

*Tomohide Sugino**

1.1 Position of the project

CAPSA implemented a three-year research project, “Identification of Pulling Factors for Enhancing Sustainable Development of Diverse Agriculture in Selected Asian Countries (AGRIDIV)” from April 2003 to March 2006, funded by the Japanese government. This research activity is in line with Theme 5 of the Research and Development Programme of the UNESCAP CGPRT Centre, the predecessor of CAPSA. Under this theme, namely, “Rural Development and Poverty Alleviation” and after the CGPRT Centre was reorganized into CAPSA in April 2004, to contribute to CAPSA’s programme goals on policies and programmes to improve the living conditions of rural poor populations in disadvantaged areas, the project aims to identify opportunities to improve rural income and welfare through development avenues provided by secondary crops as well as connected industries and services.

1.2 Background of the project

The population of the developing world has shifted its consumption mix from a diversified mix of grains, pulses, tubers and root crops to a diet in which the share of expenditure on these food sources in the household budget has declined. Rice and wheat, especially rice, have become the staple food in production policy and the consumption bundle. This trend is partially induced by the cheap food policy adopted by artificially maintaining food prices at very low levels to protect consumers through price stabilization schemes and the implementation of production expansion programmes.

Supply-side intervention has been successful in boosting production of rice and wheat in India, and rice in Indonesia, the Philippines and Thailand through productivity improvements. However, the most successful breakthroughs in productivity have occurred in more favourable agro-ecological zones and have been based on the ever more intensive use of irrigation water and modern inputs. Government intervention is made possible

* JIRCAS (Japan International Research Center for Agricultural Sciences), Japan.

through heavy investment in irrigation infrastructure facilities. These capital investments are derived from government earnings or external financial sources in the form of loans and credits.

As financial sources become more scarce both domestically and abroad, coupled with the increasing awareness of vulnerability of a country if it relies too much on external financial sources, it is not surprising that many countries have recently experienced a slowdown in food production due to stagnant irrigation development. Growth in irrigated areas has slowed sharply because: (i) existing favourable land frontiers in Asia have almost been exhausted; (ii) the exploitation of remaining irrigation potential is prohibitively costly; (iii) large-scale irrigation projects have raised environmental concerns; and (iv) the maintenance of existing schemes has diverted public funds.

The favoured-crops-biased policy is partially responsible for: (i) sub-optimal allocation of agricultural resources; (ii) competing crops, in particular secondary crops, have lost their comparative and competitive advantages in production and consumption in this region; (iii) expansion of large-scale monocropping and intensive use of modern inputs prone to resource mismanagement; (iv) dwindling genetic diversity in crops; and (v) the sustainability of the environment to support agricultural development has been challenged. The implication is that there has been a slowdown in the growth rates of yields of rice and wheat in recent years. There is also evidence of a slowdown or even a decline in total productivity and of resource degradation due to intensification. Maintaining diversified agriculture could yield some positive externalities, namely food security, risk mitigation, labour absorption, landscape or recreational value, as a source of indigenous knowledge or technology, cultural value, social capital and rural institution. Diverse agricultural systems also offer positive environmental externalities in terms of watershed protection, flood control, groundwater recharge, soil conservation, landslide prevention, biodiversity and wildlife habitat, scenic vistas and others.

Given these trends, there must be some initiatives at the decision and policymaking level and at research implementation to seek and provide ways and means to preserve the coexistence of sustainable development and diverse agriculture. A major priority in the future should be how to promote sustainable agricultural intensification and sound management of natural resources in any environment, with increased emphasis on areas with agricultural potential, fragile soils, limited rainfall and widespread poverty. Upland crops may have comparative disadvantages in well-irrigated areas, but their comparative and competitive advantages are certainly apparent in other areas. They may even regain their

competitiveness if the biased food policy is phased-out, for instance in anticipation of trade liberalization in agriculture.

Another important feature that should be noted is that the role of upland crops may have been diminished as a food staple in direct consumption, but gained in importance as raw materials for agro-processing, such as for soya sauce, soya milk, cakes and snack food, starch and flour. Starch and flour can be further developed to produce all kinds of noodles. Unfortunately, many raw materials for the noodle, cake and snack factories in the region stem from imports from countries that may impose different kinds of subsidy schemes. Indeed, the major factor encouraging wheat imports in non-wheat producing countries has been the low price of wheat relative to that of rice or other secondary food crops. This will require thorough investigation of how upland crops can be developed and made economically competitive by exploiting demand and market or product diversification potential.

The alternatives would enable surplus production to be utilized and at the same time provide benefits to crop growers, especially in poverty-stricken areas. In these less-favoured areas, secondary crops are beyond supplying food. They are not only a source of calories; they offer dietary diversity, crucial to fulfilling micronutrient needs, maintaining non-farm linkages, as a means of income risk management, and to generate income for rural poor people. In Asia, secondary crops are a source of income for millions of small-scale farmers in marginal areas, and its processing is widespread in rural and urban areas, thus establishing economic links between rural and urban areas. In marginal lands, farm growers commonly practice intercropping or mixed farming systems, in which one main secondary crop is planted with other crops in a particular set-up and sequence. This system not only maximizes the use of scarce land, but also enables the soil to be maintained and revitalized and the growth of weeds and pests restricted.

The significance of these secondary crops to the food economy of developing countries will become apparent if agricultural trade negotiations materialize, as international trade enhances efficiency through increased competition, induced learning and technology transfer. The negotiations will be likely to have a strong impact on sustainable agricultural growth in the region through further reductions in tariffs, export subsidies and domestic support linked to production, especially in favourable areas or major crops worldwide.

1.3 Objectives and expected outcomes

The principal objective of the project is to investigate socio-economic impacts of recent developments in regional and global economic environments, including trade liberalization, on upland agriculture at the village level and identify constraints to sustainable development of diversified agriculture, in particular upland agriculture based on secondary crops the Asian region.

The specific objectives are:

- To review historical developments and the current status of diversity in agricultural production and of marketing systems focusing on secondary crops;
- To critically review historical policies that may affect secondary crops consumption and utilization, agricultural systems and environment;
- To assess the impact of economic transformation and trade liberalization on secondary crops based farming systems, diversified agriculture systems and the rural economy, welfare and the environment;
- To investigate the nutritional and/or industrial importance of secondary crops as well as diversified ways of consuming them and to explore the potential of product diversification to meet changes in demand;
- To examine constraints and potential factors (economic, agro-ecology, socio-cultural) that determine the coexistence of sustainable development and diversified agriculture;
- To formulate policy options and recommendations to enhance sustainable diversified agricultural production.

Expected impacts and results are as follows.

- The project will provide specific insights into the chronological development of diversification of agricultural production and marketing systems in secondary crops based areas, through boosting CAPSA's capacity to manage, monitor and share information pertaining to secondary crops;
- Provide additional knowledge on the contribution of secondary crops to farmer income and how government policies in the region affect that income and the development of secondary crops production, marketing and processing;
- Assess the impact of recent global economic conditions on farming, diversified agriculture systems as well as rural economic development and the environment;
- Better understanding of the major constraints to expanding secondary crop farming

systems and agribusinesses;

- The results from the study will be a valuable reference for sharing experience on the development of value-added secondary crop products in the region; and
- Policy recommendations derived from the study will be used to formulate strategies to overcome constraints and promote agricultural diversification in a sustainable manner.

1.4 Analytical framework and study subjects

The study focused on the impact of recent global economic developments like trade liberalization, stock farm products including rice, environmental and domestic policies on secondary crop production, consumption, and processing in two interrelated components: (i) general approach: compiling qualitative database on secondary crops, researching and reviewing literature and analysing production, consumption, marketing and utilization of secondary crops; identifying and examining existing product development at commercial and laboratory stages, and the degree of diversification in production and consumption and its relation to economic development; and (ii) case studies: assessing characteristics of integration, in particular vertical dimensions of secondary crop production, marketing and processing activities in relation to private sector involvement and its institutional arrangements; analysing constraints and opportunities faced by farm growers and small-scale establishments to diversify production, as well as efforts to enhance diversification in production and consumption of secondary crops.

Both descriptive and quantitative analysis was used. Descriptive analysis is used to review the current situation, policies and characteristics of existing and future crop technologies and product diversification. Quantitative analysis is required to analyse direct and indirect production and consumption of secondary crop products.

The study is divided into two phases. The study subjects for each phase are presented in Box 1.1. Due to the wide range of study subjects, the framework of the project implementation is shown in Figure 1.1. In the framework, three P-factors (Poverty alleviation, Processing and Policies) are stressed as key components of project implementation.

Figure 1.1 Roadmap to AGRIDIV

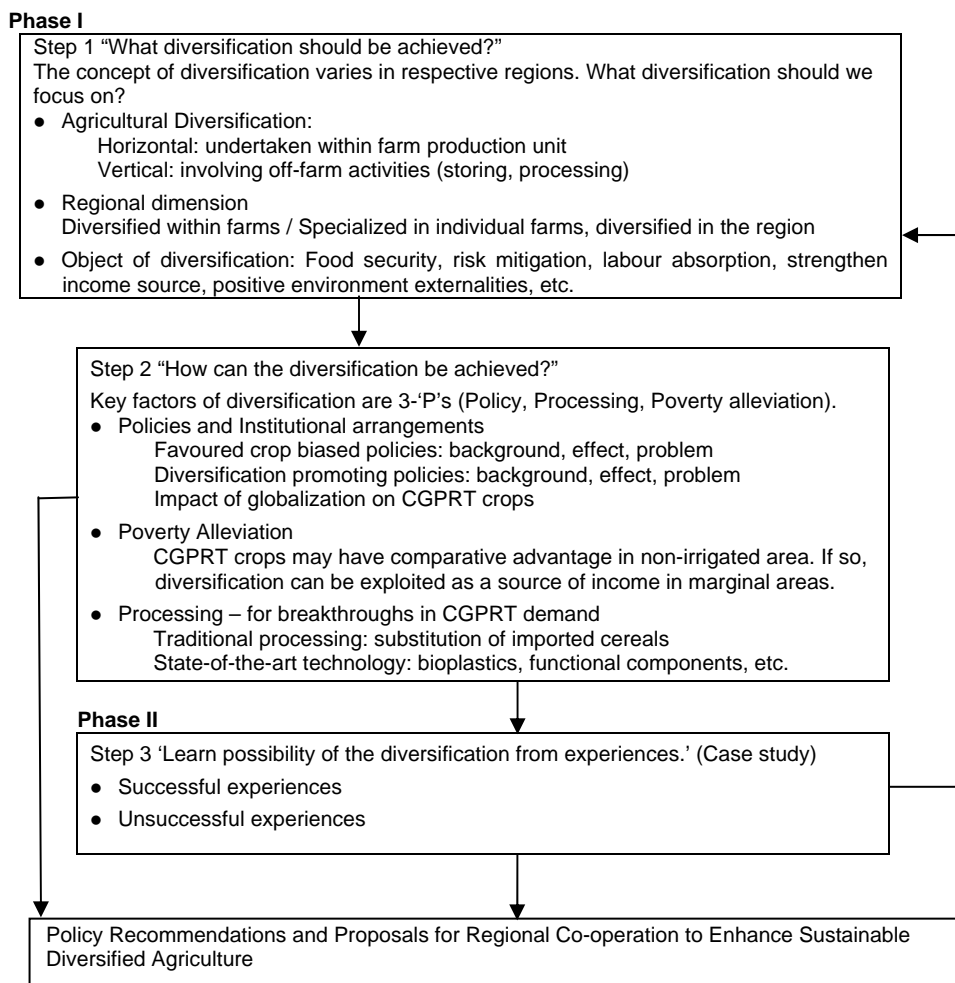

Box 1.1 Study subjects by study phase

Phase I (June 2003 - May 2004)

General:

Descriptive and quantitative analysis of current status of secondary crop agriculture and identification of its development constraints.

Details:

Country study (at national and in-country levels)

- Historical review and analysis of the general pattern of production, marketing, and consumption of crops and their products with emphasis on secondary crops;
- Identification of major constraints that determine secondary crop production, consumption and processing;
- Quantitative analysis of the impact of global trade orientation on secondary crop agriculture, including its impact on the rural economy, employment creation and the environment;
- Comprehensive analysis of the existing policies on food production, consumption and market development that may encourage or discourage diversification, the sustainability of agricultural systems, secondary crop consumption and utilization as well as the environment;
- Survey research articles on the industrial importance of secondary crops as well as diversified ways of consuming them and explore the potential of product diversification to meet changes in demand; and
- Formulation of policy recommendations to enhance the production and consumption of raw materials from secondary crops into processing.

Regional study (at regional or inter-country level)

- Historical review and analysis of agricultural production, consumption, diversification, and general and comprehensive development of food crop processing in Asia and the Pacific;
- Quantitative analysis of the impact of diversified agriculture on the rural economy and welfare, and the environment in the region;
- Literature review on the industrial importance of secondary crops as well as diversified ways of consuming them and explore the potential of product diversification to meet changes in demand; and
- Literature review on the contribution of secondary crops in preserving sustainable and diversified agriculture.

Continued

Box 1.1 Study subjects by study phase (continued)

Phase II (May 2004 - April 2005)

General:

Descriptive and quantitative assessment of performance of secondary crop based farming systems and their horizontal integration in relation to private sector processing and institutional arrangements.

Details:

Country study (at local and/or farm levels)

- Analysis of constraints and opportunities faced by farm growers to diversify production;
- Analysis of constraints and opportunities facing households and small-scale establishments to enhance diversification in production and consumption of secondary crop products;
- Investigation of the industrial importance of secondary crops and their products in the market and diversified ways of consuming them;
- Quantitative analysis of the impact of diversified agriculture on the rural economy and welfare, and the environment;
- Analysis of government policies, institutional arrangements and local factors that determine the use of local secondary crops for agricultural processing; and
- Formulation of strategic proposals and measures to counter any inhibiting factors in production expansion and industrial absorption at the national and local levels.

Regional study (at regional or inter-country level)

- Quantitative analysis of the impact of global trade orientation on upland secondary crops, including their impact on the rural economy, employment creation, and the environment;
- Quantitative analysis of the impact of technological improvements in the industrial sector, like food processing, on the supply of and demand for secondary crop production and trade in the region;
- Formulation of policy recommendations to enhance sustainable production, consumption and marketing of secondary crop raw materials into processing;
- Formulation of proposals for regional co-operation to transfer technologies and exchange information on the marketing development of secondary crop related products.

1.5 Record of project implementation

The AGRIDIV project began operationally in April 2003. Mr. Tomohide Sugino, Japan International Research Center for Agricultural Sciences (JIRCAS), Japan worked as the Project Leader (PL) and Dr. Parulian Hutagaol, Bogor Agricultural University worked as the Associate Project Leader (AL) under the overall supervision of the director. Prof. Hitoshi Yonekura, Professor, Graduate School of Agricultural Science, Tohoku University, Japan, served as the Regional Advisor (RA) throughout project implementation.

The project was implemented in collaboration with partner institutes from the eight participating countries, namely, Bangladesh, India, Indonesia, Lao People's Democratic

Republic, Myanmar, Sri Lanka, Thailand and Viet Nam. The participating countries nominated researchers as their national experts (NEs) as follows:

Bangladesh	Dr. Jahangir Alam Khan Director General Bangladesh Livestock Research Institute
India	Dr. Ram Pyare Singh Professor & Head Division of Agricultural Economics Indian Agricultural Research Institute (IARI)
Indonesia	Mr. Masdjidin Siregar, MSc. Researcher Indonesian Center for Agriculture Socio Economic and Policy Studies (ICASEPS, Reorganized from ICASERD: Indonesian Center for Agricultural Socio-Economic Research and Development in 2005.)
Lao People's Democratic Republic	Mr. Linkham Douangsavanh Head of Socio-economic Research Unit National Agriculture and Forestry Research Institute (NAFRI)
Myanmar	Mr. Aung Kyi Assistant Director Department of Agricultural Planning Ministry of Agriculture and Irrigation (MOAI)
Sri Lanka	Mr. Abdul Rahim Mohamed Mahruf Secretary Ministry of Agriculture, Livestock Development, Irrigation and Fisheries (NEP)
Thailand	Ms. Nareenat Roonnapai Director Division of Field Crop Economics Research Bureau of Agricultural Economic Research Office of Agricultural Economic (OAE)
Viet Nam	Dr. Dao The Anh Director Vietnam Academy of Agricultural Sciences (VAAS), Food Crop Research Institute (FCRI), Centre for Agrarian Systems Research and Development (CASRAD)

Chapter 1

Note: At the start of the project:

Bangladesh	Dr. Jahangir Alam Khan Member Director Agricultural Economics & Rural Sociology Div. Bangladesh Agricultural Research Council (BARC)
Sri Lanka	Mr. Abdul Rahim Mohamed Mahrouf Acting Director Socio Economics & Planning Centre Department of Agriculture
Viet Nam	Dr. Dao The Anh Deputy Head of Department Agrarian System Department Vietnam Agricultural Science Institute (VASI)

Figure 1.2 Participating countries of the AGRIDIV project

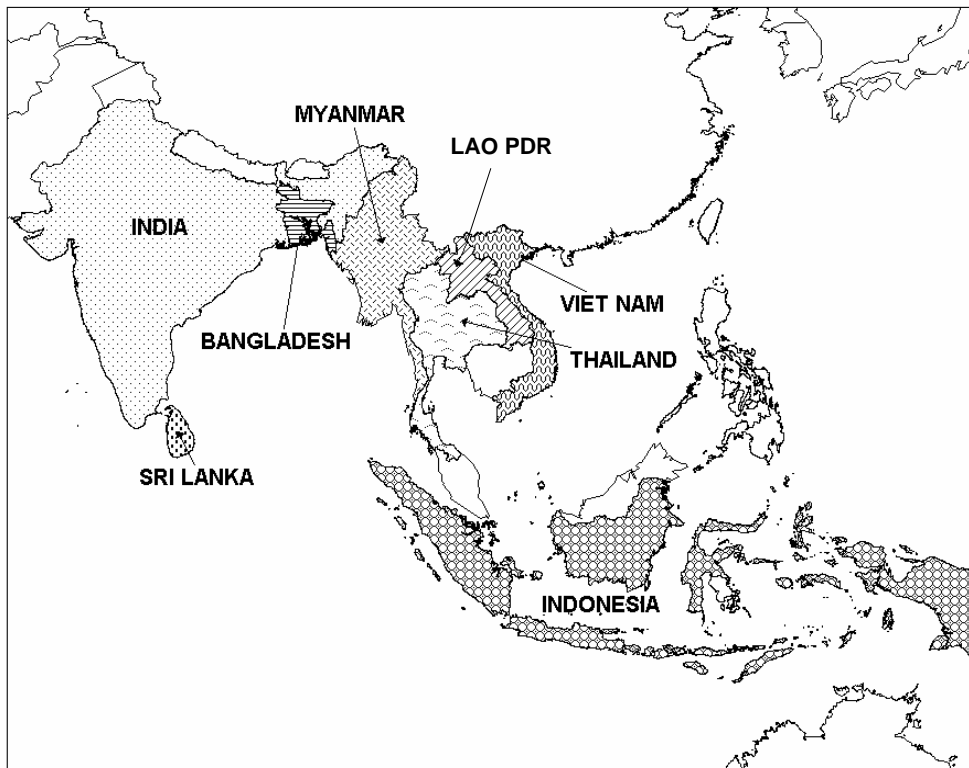

The country studies were conducted by the respective NEs based on the guidelines prepared by CAPSA, while the project leader in co-operation with the associate project leader conducted the regional study. The NEs organized a loose and temporary group or team with eligible members to effectively conduct the country study.

A pre-planning consultative meeting was held on 15th July 2003 at CAPSA (at the time CGPRT Centre), with the participation of the national expert of Indonesia, the project leader and CAPSA's staff. Based on the preliminary discussion between the project leader and the regional advisor, the agenda of the planning meeting and other related issues were discussed.

A planning meeting for the first phase was held on 5-6 August 2003, at CAPSA (at the time, CGPRT Centre) with the participation of the regional advisor, the project leader, national experts and CAPSA's staff. Resource persons were also invited from participating countries to present the relevance of the project, recommendations to make the research output more relevant to policy-making, existing and planned policy measures enhancing agricultural diversity and other information relating to the project.

The national experts presented rough ideas on project implementation including immediate objectives, survey and analytical methods, formation of study teams and the work plans for Phase I and Phase II. After discussion on the study plans, it was agreed that:

1. The study should begin with the identification of beneficiaries, and the significance of agricultural diversification in participating countries and the final goal should be policy recommendations to each government to enhance agricultural diversification.
2. The scope of study should focus on crop diversification of secondary crops.
3. For the integration of country study results and to illustrate more generalized policy implications applicable to the Asia Pacific region, each country should implement their study concerning three common subjects ((i) Effect of global economic changes on secondary crops and agricultural diversification; (ii) Possibility of poverty alleviation through secondary crop development; and (iii) Prospects of agro-processing using secondary crops), other than country specific subjects adopted in accordance with the conditions in respective countries.
4. The target crops should be selected according to their significance in the region such as the production level, industrial use and political importance, etc.

Interim reviews were undertaken at intermediate periods of both the first and second phases, as the RA, PL and AL visited each participating country to monitor the progress of the study, as well as discuss and advise further implementation.

Chapter 1

First Phase:	Viet Nam	9-10 February 2004
	Lao People's Democratic Republic	11-13 February 2004
	Thailand	16-18 February 2004
	Myanmar	19-20 February 2004
	Indonesia	26 February 2004
	Bangladesh	8-9 March 2004
	India	11-12 March 2004
	Sri Lanka	14-16 March 2004
Second Phase:	Myanmar	28 February-1 March 2005
	Viet Nam	3-4 March 2005
	Lao People's Democratic Republic	7-8 March 2005
	Thailand	10-11 March 2005
	Sri Lanka	13-16 March 2005
	India	17-18 March 2005
	Bangladesh	20-22 March 2005
	Indonesia	18 April 2005

The draft report (1st phase) and planning (2nd phase) meetings were held on 20-22 July 2004 at CAPSA, with the participation of the RA, PL, AL, NEs and CAPSA staff. At the draft meeting, preliminary results of the regional study and the draft country study reports were presented. At the planning meeting, the work plans were presented by NEs and discussed. The second draft report meeting was held on 19-20 July 2005 at CAPSA.

A Workshop on "Rural Prosperity and Secondary crops in Asia and the Pacific", co-organized by CAPSA and the Indonesian Centre for Food Crop Research and Development (ICFORD) was held in ICFORD's conference room from 6 to 9 December 2005. More than 30 participants from 14 Asian countries, including all the AGRIDIV participating countries and five regional or international institutions, attended the four-day workshop.

Seventeen papers presented cases and experiences related to research, policies and/or development actions with the objective of providing useful facts on how poverty alleviation could be promoted through secondary crop development. The case studies ranged from housewives groups involved in soybean paste processing in Thailand to the introduction of improved yam varieties in Papua New Guinea, to the development of potato processing in Sichuan, China and the adoption of maize technology in India.

The rationale for selecting this topic stems from the fact that poverty alleviation is the first Millennium Development Goal and the highest priority for governments in Asia and the Pacific. Rural poverty in particular still represents the core of poverty in Asia and the Pacific and an important cause of urban poverty due to rural/urban migration. Moreover, most of the rural poor live in disadvantaged areas and face harsh natural, socio-economic and political conditions. They rely on secondary crops for subsistence and occasional cash. Secondary

crops have potential to generate higher added value and increase well-being but policies and research usually pay little attention to how this potential can be made a vehicle to lift people out of poverty. Thus, bringing evidence on the contribution of secondary crops to poverty alleviation is needed to enlighten and help design and implement effective pro-poor research and policies.

For this reason, CAPSA invited not only scientists but also people from the policy world from each participating country in an attempt to bridge the gap between science and policy. The workshop layout provided several opportunities for scientists and policymakers to interact. The latter were systematically discussants of the papers presented by the former. In addition, a full day was devoted to working group sessions, giving more time for deeper exchanges among participants. The working group sessions helped participants to synthesize facts and key implications from the numerous presentations with a focus on two issues: lessons learnt and criteria for assessing how far research, policies and development actions based on secondary crop development are genuinely pro-poor.

This workshop was but the first step towards the establishment of collaborative links with the participating countries, hopefully leading to the establishment of common country and regional work programmes, where the participants will play a key role as contact, resource person and implementer in each country.

A series of in-country seminars was conducted in each participating country to disseminate the research results and country specific policy recommendations. The following is a record of in-country seminars:

Bangladesh	AGRIDIV in-country seminar: Diverse Agriculture and Agribusiness for Poverty Alleviation through Promotion of Secondary Crops, Dhaka, 27 February 2006, organized by BARC
India	Country Seminar on Livelihood Security through Secondary Crops in India, New Delhi, 20-21 February 2006, organized by IARI
Indonesia	Seminar on Poverty Alleviation through Development of Secondary Crops in Indonesia, Bogor, 23 March 2006 organized by ICASEPS
Lao People's Democratic Republic	AGRIDIV in-country seminar: Poverty Alleviation through Diversified Agriculture: in case of Lao People's Democratic Republic, Vientiane, 2-3 March 2006, organized by NAFRI
Myanmar	In-country Seminar on Impact of Secondary Crop Development to Poverty Alleviation through Diversified Agriculture, Yangon, 7 March 2006, organized by MOAI

Chapter 1

Sri Lanka	In-country seminar on Poverty Alleviation through Diversified Agriculture, Gannoruwa, 20-21 March 2006, organized by Department of Agriculture
Thailand	AGRIDIV in-country seminar: Poverty Alleviation through Diversified Agriculture in Thailand, Chiang Mai, 16-17 January 2006, organized by OAE
Viet Nam	AGRIDIV in-country seminar: Poverty alleviation through diversified agriculture in Viet Nam, Hanoi, 9-10 March 2006, organized by VASI

1.6 List of publications

The first and second country reports were published under CAPSA's Working Paper series (WP) as follows:

- WP 80 Enhancing Sustainable Development of Diverse Agriculture in Bangladesh, by Jahangir Alam (April 2005).
- WP 82 Enhancing Sustainable Development of Diverse Agriculture in India, by R.P. Singh, N.P. Singh and Ranjit Kumar (April 2005).
- WP 83 Enhancing Sustainable Development of Diverse Agriculture in Sri Lanka, by A.R.M. Mahrouf (May 2005).
- WP 85 Enhancing Sustainable Development of Diverse Agriculture Through CGPRT Crops in Myanmar: Current Status of CGPRT Crop Agriculture and Identification of its Development Constraints, by Aung Kyi (August 2005).
- WP 86 Enhancing Sustainable Development of Diverse Agriculture in Viet Nam by Dao The Anh, Le Duc Thinh, Vu Trong Binh (November 2005).
- WP 87 Secondary Crops Based Farming Systems and Their Integration with Processing and Marketing in Bangladesh, by Jahangir Alam (November 2005).
- WP 88 Identification of Pulling Factors for Enhancing the Sustainable Development of Agriculture with Special Reference to Maize in India by R.P. Singh, Ranjit Kumar and N.P. Singh (November 2005).
- WP 89 Enhancing Sustainable Development of Diverse Agriculture in Lao People's Democratic Republic, by Linkham Douangsavanh, Bounthong Bouaham, Khamphou Pouyavong (December 2005).
- WP 90 Enhancing Sustainable Development of Diverse Agriculture in Thailand, by Nareenat Roonnapai (February 2006).
- WP 91 Identification of Pulling Factors for Enhancing the Sustainable Development of Diverse Agriculture in Myanmar, by Aung Kyi (April 2006).

- WP 92 Pathways out of Poverty through Maize and Job's Tear in Lao People's Democratic Republic, by Linkham Douangsavanh and Bounthong Bouahom (June 2006).
- WP 93 Pathways out of Poverty through Cassava, Maize and Soybean in Thailand, by Nareenat Roonnapai (July 2006).
- WP 95 Pathways out of Poverty through Secondary Crops and Private Sector Processing as well as Institutional Arrangements in Viet Nam, by Dao The Anh, Le Duc Thinh, Vu Trong Binh and Dao Duc Huan (September 2006).
- WP 96 Secondary Crops Based Farming Systems and their Integration with Processing and Marketing in Sri Lanka, by Abdul R.M. Mahrouf (September 2006).
- WP 97 Enhancing Sustainable Development of Diverse Agriculture in Indonesia, by Masdjidin Siregar and Muhammad Suryadi (October 2006).
- WP 98 Secondary Crops Based Farming Systems and their Integration with Processing in Lampung, Indonesia, by Masdjidin Siregar, Naoko Nagai and Muhammad Suryadi (October 2006).
- WP 99 Integrated report of the Project "Identification of Pulling Factors for Enhancing the Sustainable Development of Diverse Agriculture in Selected Asian Countries", by Tomohide Sugino, Hitoshi Yonekura and Parulian Hutagaol (October 2006).

The proceedings of the regional workshop "Rural Prosperity and Secondary Crops Towards Applied Pro-poor Research and Policies in Asia and the Pacific (RUPSEC)" held during 6-9 December 2005 in Bogor, Indonesia were published under the CAPSA's Monograph series as follows:

- Monograph No. 48 Proceedings of the Regional Workshop on "Rural Prosperity and Secondary Crops: Towards Applied Pro-poor Research and Policies in Asia and the Pacific" – Farming a Way Out of Poverty: Forgotten Crops and Marginal Population in Asia and the Pacific, edited by Robin Bourgeois, Lisa Svensson, Matthew L. Burrows

The proceedings of the in-country seminar "Seminar on Poverty Alleviation through the Development of Secondary Crops in Indonesia" held on 23rd March 2006 in Bogor, were published under the ICASEPs' Monograph series as follows:

- Monograph Series No. 27 *Diversifikasi Usaha Tani dan Konsumsi: Suatu Alternatif Peningkatan Kesejahteraan Rumah Tangga Petani* (Diversification of Agriculture and Consumption: Alternatives to Improve Welfare of Farm Households), by Kedi Suradisatra, Yusmichad Yusdja, Masdjidin Siregar and Ketut Kariyasa (September 2006)

Parts of research results of the project were presented in publications as below:

Sugino, T., 2003, Identification of Pulling Factors for Enhancing the Sustainable Development of Diverse Agriculture in Selected Asian Countries (AGRIDIV). Palawija News¹ 20(3).

Sugino, T. and Parulian, H., 2004. Tips for Realizing Sustainable Diversified Agriculture with Optimal Profit through Exploitation of CGPRT Crops. Palawija News 21(1).

Sugino, T., 2006. Prioritization of Technological Development Goals for Poverty Alleviation through Sustainable and Diversified Agriculture. Asia-Pacific Development Journal (Accepted).

1.7 Organization of the integrated report

This integrated report consists of ten chapters. Chapter 1 introduces the framework of the project and summarizes the record of project implementation. Chapter 2 presents general concepts of agricultural diversification for the basic information of the AGRIDIV project. Chapter 3 is an overview of the socio-economic characteristics and agricultural structure of the project's participating countries. Chapter 4 presents historical and current status of secondary crops and mentions historical trends of agricultural diversification both at the national country and regional levels. Chapter 5 presents historical and current status of industrial uses of secondary crops and their future prospects, especially focusing on modern processing. Chapter 6 presents the results of questionnaire surveys to identify the priority areas of research and development for agricultural diversification. Chapter 7 presents the future prospects of regional co-operation for agricultural diversification. Chapter 8 concludes the report with policy recommendations.

¹ Palawija News: CAPSA's quarterly newsletter.

2. General Concepts of Agricultural Diversification

*Parulian Hutagaol**

2.1 Introduction

Agricultural diversification is not new for developing countries, including the Asia-Pacific region. In fact, according to Francis (1986), agricultural diversification was the first type of organized agriculture in the world. The struggle to attain food self-sufficiency since the mid-1960s has, unfortunately, led to a rapid decline in popularity of agricultural diversification in this overpopulated region. This is because most countries of the region have tried to meet the challenge of food self-sufficiency by simply focusing on steadily boosting production of a particular crop, notably rice. This leads to increasingly less diversified agriculture.

By employing this strategy, many countries have been quite successful in managing their food shortage problem, some even producing a food surplus. However, the success in raising food production has never solved problems of hunger and poverty. Poverty and hunger are still at large in developing countries (Todaro, 2000; Rosegrant and Hazell, 2000). If previously hunger and poverty could co-exist with chronic food shortages, now they exist side by side food surpluses. So, hunger can no longer be attributable to shortages of food supply, but due to the lack of access to food. The major cause of this lack of access is the food self-sufficiency programme, which not only discriminates against the rural poor from gaining from the benefits (Griffin, 1971), but has also exacerbated their job opportunities (Grabowsky, 1985). As income has suffered, so to the ability to buy food. Hence, hunger can co-exist with a surplus of food.

This tragedy of food surplus, as Sen (1981) has termed it, is only part of the drawbacks of the rice self-sufficiency programme in the region. Another crucial problem in the wake of the programme is the rapid degradation of the environment and natural resources that has become commonplace in the region (Rosegrant and Hazell, 2000). While it is true that this problem is not only due to the rice self-sufficiency programme, the programme contributes significantly to it, directly and indirectly. This problem is a serious

* Associate Project Leader AGRIDIV project, UNESCAP-CAPSA, Bogor, Indonesia.

threat to the sustainability of agriculture, since agriculture in the region is highly dependent on the use of natural resources and the environment.

This reality provokes concern to promote agricultural diversification, which is desirable not only for the conservation of natural resources and the environment, but, more importantly, to improve the well-being of marginalized rural people. Therefore, the challenge is to develop concepts of agricultural diversification that promote the attainment of these twin goals.

This chapter is devoted to discuss some aspects of this concept. First, the meaning of agricultural diversification will be discussed followed by how to fit the concept of agricultural diversification to the alleviation of rural poverty. Then, the focus switches to the required public policies to support the implementation of the concept. The chapter is concluded with closing remark that sum up the discussion.

2.2 Meaning of agricultural diversification

Agriculture is a broad sector of the economy, including not only crop cultivation, but also fisheries and animal husbandry. However, this chapter will be confined to diversification in the context of crop agriculture.

Even when confined to this context, agricultural diversification remains a very broad concept. This is because agricultural diversification can be seen from different perspectives. Different perspectives imply not only different meanings, but also different rationales behind agricultural diversification and its impacts on the rural economy and environment

Following Hedley (1987), agricultural diversification may be classified into three forms, namely horizontal diversification, vertical diversification and regional diversification. The first kind essentially deals with diversification of activities at the farm level. Farmers may do this in a variety of ways. One possibility is to plant a variety of crops on the same plot of land at the same time.

This kind of agricultural diversification (also known as inter-cropping), is commonly practised by small-scale farmers whose families face poverty (Lynam, Sanders and Mason, 1986). As the loss of even a little income resulting from production or price failure could endanger their ability to meet their family subsistence needs, such farmers generally prefer not to maximize profit, but to secure stable family income from their farm. They are risk-averse and their risk attitude is exercised in their farming operation.

The intercropping system fits with their attitude to risk as it reduces yield and price uncertainty. Effects of change in nature, like the weather, and market on different crops

would be different (Lynam, Sanders and Mason, 1986), so that their negative and positive effects would tend to negate one and another. This is the underlying reason that makes this type of diversification generally recognized as good for stabilizing farm income.

An alternative way of implementing horizontal diversification is sequential cropping whereby on the same plot of land crops are planted in sequence after the previous crop is harvested. By employing sequential cropping farmers make the use of land and other inputs such as labour become more intensive. Such action is attractive for farmers, especially when they have an abundant supply of labour, but limited availability of land. Farmers thus make their resources more productive and hence, generate more income for their family. However, multiple cropping can be possible only if the irrigation system is well developed, since fast maturing crops are normally heavily reliant on water for good yield performance. These are apparently the main underlying reasons why this kind of horizontal diversification is very commonly practised in irrigated rice production areas where high population pressure on farmland prevails, as Lynam, Sanders and Mason (1986) have reported.

Farmers often do not constrict their cultivation to a particular crop from one season to the next. They may replace one crop with another crop as they find the existing crop no longer as profitable. Farmers with a commercial attitude take such actions in response to changes in the market. They do this not simply for the purpose of protecting themselves from loss of income if continuing to operate with the existing crop, rather, they move on to the cultivation of a new crop with the expectation of higher income. This expectation is rational as it is dictated by changes in market environment. This kind of farming strategy is also considered as another type of horizontal diversification.

Vertical diversification is quite different from horizontal diversification. In the context of horizontal diversification, farmers diversify income-generating activities at the farm level. This is either for the purpose of risk management, or to generate higher income through either fuller or better use of the farm resources that they control. Meanwhile, in the context of vertical diversification, farmers do not diversify activities at the farm level. Rather, they extend an activity previously taken only at the farm level a step further or beyond. They now undertake off-farm activities that can include processing, storing and distribution of the products (Taylor, 1994). These additional activities add value to their products.

Farmers may undertake these activities themselves or in co-operation with other business entities, such as agricultural traders or manufacturers. It is certain that vertical integration helps farmers make fuller use of the resources they own in surplus, notably

labour. Such vertical diversification generates higher income than otherwise. However, farmers may require assistance to undertake such activities.

Off-farm activities may require a substantial amount of investment either to develop storage, processing or distribution facilities and/or for marketing. This investment requirement is a critical hindrance for most farmers in developing countries, including Asia-Pacific to commit for vertical diversification in two ways. First, most farmers in this region are small-scale farmers. They are too poor to make this investment requirement. Second, the investment is a quasi-fixed investment. This implies that it is only efficient to undertake when market operations are on a relatively large scale. Again, their smallness of operation prevents most farmers from vertical diversification themselves.

Farmers in this region are unlikely to take such vertical diversification themselves. One possibility for them to engage in vertical diversification is through the development of co-operation. To meet the required investment and the corresponding economies of scale, such co-operation may involve hundreds of small farmers. One problem of organizing a large number of farmers to pursue a set of collectively decided goals is it is highly vulnerable to individual members trying to free ride (Olson, 1971).

Another possibility for farmers to engage in vertical diversification is through the development of business partnerships with commercial agricultural institutions, such as large agricultural traders and manufacturers. Through this co-operation, all sides of the partnership can combine their own specialty to generate business synergy. Thus, the farmers may specialize in farm production of agricultural raw materials, while the commercial institutions may specialize in processing and marketing. Through work specialization of this kind, the business partnership makes agricultural production and marketing more efficient. However, fairness is critical for the maintenance of the business partnership in sharing the generated benefits. Unfairness provokes reactions from the aggrieved party. This could lead to the collapse of the partnership.

Regional diversification relates to production specialization by region. The logic behind regional production specialization rests on the concept of comparative advantage formulated by David Ricardo. According to this concept, regions will be better off when each of them specializes in the production of crops for which it has comparative advantage and trade their production among them. When each region specializes in particular crops, agriculture becomes diversified from the national perspective.

Free trade is a prerequisite for this kind of agricultural diversification to prevail. When trade between regions is constrained, it is very unlikely that regional specialization can take

place. Conditions of transportation reflected by transport cost (in terms of money spent and time) are crucial for trade to prevail. When the cost is prohibitively expensive, trade between regions becomes unprofitable for private business to undertake. Consequently, regional specialization becomes unfeasible.

There are, however, some other factors that may prevent regional specialization taking place on a large scale in developing countries including food self-sufficiency policy and the risk attitude of farmers. As governments of developing countries commit to food self-sufficiency, they prefer to spread food production throughout the country, rather than concentrate it in particular regions.

There are reasons to justify such a decision. Firstly, since transportation facilities are not well developed in these countries, mobilization of food from the producing areas to other areas is much more expensive. As a significant portion of the population is relatively poor, this would make the food become too expensive for them.

This is contradictory to the purpose of self-sufficiency whereby food should be available to every citizen. Secondly, the fact that food production in developing countries is heavily reliant on the natural environment, especially the weather, it is risky to concentrate food production to a limited region. In the event of a natural disaster, like a flood, food production could be completely destroyed. This could spell political disaster for the incumbent government. Lastly, high population growth in most of these countries makes it impossible to limit food production to certain parts of the country. Steady increases in domestic demand for food, resulting primarily from population growth require production to be expanded from time to time. Since production technology is not developed rapidly, the food production area must be expanded.

Regional specialization means that farmers of the concerned region will only cultivate a crop for which it has comparative advantage. This implies that farmers have to rely only on a single crop for their livelihood. Farmers may reject such a farming strategy simply because production or marketing failure could be too expensive for them to bare. This is true especially for small-scale farmers who lack the capacity to absorb failure.

2.3 Fitting the concept of agricultural diversification to the alleviation of rural poverty

From the preceding discussion, it is clear that agricultural diversification is a critical avenue for rural poverty alleviation in developing countries. This does not, however, mean that developing countries have to abandon food self-sufficiency to allow for the promotion of

agricultural diversification. Indeed, its abandonment is not a requirement for the promotion of agricultural diversification because agricultural diversification can be integrated into the food self-sufficiency programme.

The real challenge for these developing nations is not, therefore, the abandonment of the food self-sufficiency programme it is how to design agricultural diversification within the context of food self-sufficiency that promotes the welfare of the rural poor.

The promotion of agricultural diversification requires the government to relax the food self-sufficiency programme, not to simply rely on the production of a particular food crop, such as rice, alone. Secondary food crops such as maize, cassava and potato should be integrated into the food self-sufficiency programme. The self-sufficiency programme has to be a multi-food crops based programme.

In developing countries, through the generations, people were accustomed to production and consumption of not only rice, but also secondary food crops. Multi-staple food was typical in these societies. However, this character has almost disappeared since the success of rice production intensification. Government policy that makes rice available at cheap prices everywhere at any time and the lack of support for the production and distribution of non-rice food crops to a great extent have been major factors behind the disappearance of multiple staple foods. Reorienting this policy would encourage people to return to traditional, multi-staple food consumption.

By returning to multi-staple food consumption, the market for products of secondary food crops would improve greatly in developing countries. The increasing demand for these products would, in turn, provide better monetary incentives for their producers to boost production. This will make developing countries less dependent on a single food crop (rice) for food self-sufficiency.

The majority of the marginalized farmers in developing countries have been forced to turn to marginal upland areas for survival through the cultivation of secondary food crops such as maize, cassava and potato. For them production of these crops is not simply for subsistent food, but also a source of cash to be used to buy other necessities. Given the geographical location and quality of the soils the farms operate, it is hard to expect poor farmers to secure good income. They can do it only if the government provides strong support through appropriate public policy. However, the fact that the government has focused on intensification of rice production has made farm operations beyond the reach of government support.

Integration of secondary food crops into the food self-sufficiency programme would be crucial for the poor to raise their farming profitability enabling them to obtain a higher level of income. This would not only lead to improvements in the market for secondary crops that they produce, but would also provoke the government to institute policy support for their crops.

Certainly, poor farmers will not automatically be able to enjoy the benefits brought by improvements in the macroeconomy for secondary crops through their integration into the food self-sufficiency programme. As profit oriented farmers, logically, rich farmers would be interested in collecting the benefits for themselves through their involvement in the production of secondary crops. Therefore, poor farmers will have to compete with rich farmers in the market for secondary food crops. Poor farmers are likely to lose such a battle.

This implies a proper design of agricultural diversification is necessary if the poor farmers' economic interests are to be promoted through agricultural diversification. In the previous sub-chapter, a variety of types of agricultural diversification were discussed. From this discussion, one can recognize that the best way for farmers to maximize benefits from agricultural diversification is to involve vertical diversification. This means that farmers have to involve not only farming operations, but also extend their involvement to post-harvest activities in order to add value to their production. The integration of post-harvest activities into their farming operations will earn much higher income.

However, poor farmers cannot themselves pursue vertical agricultural diversification, since it often requires a massive investment to fund the operation. Their skill level may also prevent them from post-harvest activities since these activities often require more complex skills than the poor farmers have.

One way to solve the investment and skill shortfalls is to develop business partnerships between poor farmers and commercial agricultural processors or traders.

The balance of bargaining power between the partners is another important factor for the sustainability of business partnerships. This is so because any business partnership is vulnerable to opportunistic behaviour from any of the involved parties (Williamson, 1985). A party with stronger bargaining power may attempt to use this to exploit the weaker partner. Such exercise of power would destroy the incentives of the weaker party. An effective way to prevent such opportunistic behaviour is to improve the power of the weaker party so as to level the playing field.

In the context of partnership between the poor farmers and large-scale commercial secondary food crops processors, the possibility of such power abuse by the large

processors is a real threat. A way to improve the bargaining position of these poor farmers is to organize them into a collective to deal with the processor. This requires the poor farmers to form an organization that they can use as an instrument for collective bargaining. The organization can take form of agricultural co-operative or farmer association.

Another strategy to help poor farmers get involved in vertical business diversification is to organize them into an agricultural co-operative. Such an institution would act as a medium for them to pool their resources and skills to handle the post-harvest activities. However, any organization for collective action such as agricultural co-operatives are likely to confront problems of free riders (Olson, 1970). Accordingly, the effectiveness of the co-operation to enhance the interest of the poor farmers through vertical agricultural diversification is determined by their ability to control the possibility of members to commit opportunistic behaviour. Internal rules can be designed as a key instrument to combat opportunistic behaviour of the members.

The potential of horizontal agricultural diversification for the alleviation of rural poverty cannot be ignored. However, from the previous discussion it can be seen that its potential for rural poverty alleviation is limited. One strategy to make the best use of horizontal agricultural diversification is to integrate into vertical agricultural diversification. Therefore, a group of farmers involved in vertical agricultural diversification may also simultaneously undertake horizontal diversification. In reality, farmers often combine vertical and horizontal agricultural diversification as a strategy to achieve the twin goals of risk management and income improvement. Through experience, farmers can make the correct decision as to whether to combine the two or not.

In short, one can argue that vertical agricultural diversification through the development of secondary food crops has great potential for rural poverty alleviation, and its potential is enhanced further when horizontal agricultural diversification is integrated into it. However, this potential can only be fully realized if the government provides strong support for its exploitation through appropriate public policies. The following section extends the discussion on the development of appropriate public policies to support vertical diversification through the development of secondary food crops.

2.4 Mobilizing government support for successful agricultural diversification

The recent drive to tighten global co-operation between UN members to halve the incidence of global poverty by 2015 suggests the urgency for developing countries to

improve their commitment and public policies for poverty alleviation. In line with this, the following public policies are suggested to be implemented to make agricultural diversification through the development of secondary food crops an effective instrument for the alleviation of rural poverty in developing regions, including Asia-Pacific.

Social, economic and political condition in developing countries are quite heterogeneous from one country to another. The public policies identified are best considered as basic requirements for the successful implementation of vertical agricultural diversification.

Categorically, the required public policies can be divided into two sets. The first set consists of public policies that are fundamental for the development of market forces conducive for agribusiness. Conducive market forces are essential for poor farmers and their counterpart entrepreneurs to engage in agribusiness. The extent of market forces determines the scope and level of rewards that stakeholders can earn from the market for their investment and skill. Satisfactory rewards are desirable if vertical agricultural diversification is to be promoted as an effective means for rural poverty alleviation. Hence, governments need to direct public policies at stimulating the development of markets for products of secondary crops. Such public policies may be termed as basic public policies.

The second set consists of public policies that enable poor farmers and their collaborating entrepreneurs to generate maximum benefits brought by favourable market forces. Even if the market is favourable for agribusiness, the producers, especially the poor farmers, may not be able to participate because of a lack of accessibility to the required inputs, such as credits and technology. This set of public policies may be termed as enabling public policies.

2.4.1 Basic public policies

Food diversification policy

An important public policy that belongs to this category is food diversification policy. As previously explained, the current food self-sufficiency programme in developing countries is a self-sufficiency programme based on a single food crop. In the Asia-Pacific, most countries have made rice the foundation for food self-sufficiency programmes. Such an orientation is inappropriate. First, the programme makes countries become dependent on domestic production of a single crop to feed their population. This is a very risky endeavour, since any crop is subject to some degree of production failure. When failure becomes reality, such countries resort to importation of this food from the international market. If the

countries have sufficient foreign reserves imports may be feasible. If not, such countries may face mass starvation, which could lead to social-political disorder.

Second, while single food crop based programmes like the rice self-sufficiency programme, have succeeded in making breakthroughs in overcoming food shortages in some Asia-Pacific countries, they do not eradicate hunger. In fact, mass starvation often co-exists with surplus food supply. This tragedy of food surplus is because the programme denies access of the poor farmers to the benefits and also destroys their job opportunities that leaves them without sufficient income to buy subsistence food.

This implies that developing countries should develop credible policies for food diversification. Successful food diversification will expand the market for products of secondary food crops. Growing demand for these products will create economic incentives for their producers. Furthermore, as the production of secondary food crops begins to play a significant role in a country's food security, the respective government can relax its support for rice production and channel more support to secondary food crop production.

Before developing countries committed to rice self-sufficiency, their inhabitants were already accustomed to the consumption of multiple staple foods. The policy that makes rice available everywhere, cheaply and at anytime has made the consumption of secondary food crops less common. This condition can only be changed if the cheap rice policy is eliminated. It has to be replaced with a food diversification policy that encourages the consumption of secondary food crops. In addition, the policy should also promote the production of secondary crops to boost domestic supply to meet the expected rise in demand for secondary food products.

Policies promoting the development of a secondary crops based processing industry

It used to be true that secondary crops were primarily used for food. However, the development of modern technologies has made the processing of secondary crops for uses other than human consumption become tremendously opportunistic. For instance, producing ethanol from cassava is one of the most promising opportunities since the hikes in the prices of fossil oils recently. The current soaring prices of fossil fuels in the global market have made the production of cassava-based ethanol economically feasible. Likewise, maize can be processed into products other than food for human consumption. Maize has become the most popular basic input used by the animal feed industry, which is growing rapidly in many developing countries.

The development of this industry will provide a huge source of market demand for secondary food crops. Indeed, the presence of a buoyant processing industry can be critical for vertical agricultural diversification to become an effective instrument in the alleviation of rural poverty.

The transformation of secondary food crops into other industrial goods creates potential advantages. First, the transformation greatly extends demand for secondary food crops, leading to more labouring jobs at the farm level and hence, more income. Secondly, if poor farmers have not only labour service to sell, but also a small plot of farmland, the growing demand for secondary crops should generate more income from their land as farm profitability is raised. An increase in the demand for secondary food crops will raise their prices, boosting the profitability of their production.

The third advantage stems from processing secondary food crops into industrial products. Poor farmers can only access this route out of poverty if they can involve themselves in agricultural vertical diversification. By processing secondary food crops into industrial products, processors ensure the demand for their products becomes less elastic; demand becomes less sensitive to price fluctuations. This is beneficial for the producer in terms of his ability to dictate market prices. As such, the processing of secondary food crops becomes more profitable.

When poor farmers are involved not only in farming secondary crops, but also in vertical agricultural diversification, they can reap many benefits. Income is likely to increase quite significantly. Even if poor rural families only have labour disposable, they are likely to experience a rather significant rise in income. A buoyant industry will significantly improve labouring opportunities at the farm level and also the processing level.

An emerging question is what can the government do to foster development of such a processing industry in developing countries. Development requires investment. Modern industrial processing industries like ethanol or the feed industry require substantial investment, which can come from domestic or overseas investors. Investors are only even willing to invest in an industry if the investment has good potential, which is determined by many complex factors. Public policy intervention can be a critical factor in determining the prospects of the processing industry. Hence, an appropriate public policies is important to foster the development of secondary crop processing industries in developing countries.

This will include such policies as an appropriate investment permit policy, taxation policy and international trade policy. All policies should be designed to provide public

support to the development of the industry, which is socially justified since it will alleviate rural poverty.

Nevertheless, governments should pay special attention to appropriate international trade policies since international trade can have a tremendous effect on the prospects of the processing industry and its function in the alleviation of rural poverty. First of all, development of the processing industry can have significant effects on the alleviation of rural poverty provided the industry vertically integrates with poor farmers and their farm operations. In this context, the farmers can act as a source of raw materials for the industry.

A mechanism through which international trade can affect the prospects of the processing industry is through the importation of secondary food crop raw materials. Importation is feasible only if the imported raw materials can compete with the domestically produced raw materials. This can destroy the prospects of integration between poor farmers and the industry.

However, when prices of imported raw materials are lower than domestic prices it is often due to unfair trade practices, such as input subsidies, by the exporting country's government. If poverty alleviation is to be a primary concern of the domestic processing industry, the government has to counter such unfair international through its own international trade policy.

Likewise, the importation of secondary crop based products can also destroy the capacity of the processing industry to alleviate rural poverty in developing countries. Again, the government should implement appropriate trade policies to protect the domestic industry from unfair competition from abroad.

The government should not only focus on the protection of its domestic markets of raw materials and end products, the export market can be a driving force for processing industry development. This can be harnessed through the implementation of appropriate international trade policies that support the processing industry in exporting their products to the international market.

2.4.2 Enabling public policies

Successful promotion of food diversification and a secondary crop based processing industry will boost the demand for secondary crop raw materials. Poor farmers, however, will not automatically benefit from this market development. Poverty implies not only a lack of access to income and food, but also to many valuable necessities such as capital, technology and skill. Accordingly, the government should implement a set of policies that enables farmers to benefit from the growing market for the products of secondary crops. If

this growing market is to be harnessed to abate rural poverty, indeed, the government should implement policies that ensure the poor farmers benefit. To this end, the following public policies have been identified as a minimum requirement for the government to implement.

Infrastructure development policy

Poor farmers generally have to work in remote marginal upland areas. The land is not only marginal in terms of soil properties, but also in terms of supporting infrastructure, such as irrigation and transportation facilities. The marginal properties of the soil have become so serious that the farmers are unable to generate a sufficient level of income for their family. However, the desperate conditions are often exacerbated further by the lack of facilities.

This implies that the development of good infrastructure is critical for poor farmers to participate in the growing market. Some secondary crops like cassava can be grown under dry conditions, while some other crops such as maize cannot. Notwithstanding, all secondary food crops grow very well if they are planted on irrigated farmland. In addition, irrigation improves cropping intensity of formerly dry land. Thus, the development of good irrigation systems can significantly boost the productivity of secondary food crops.

As poor farmers often inhabit remote areas, coupled with the fact that their farm products are bulky and perishable, the quality of transportation is a crucial determinant of the profitability of secondary food crops. Upgrading existing transportation facilities would greatly affect farmer income. Accordingly, the government should also place priority on infrastructure development.

Farm technology and extension service policy

Poor farmers' inability to generate sufficient income is also partly attributable to the low quality of production technology used. Advancing technology is another prerequisite to improve farm productivity, and hence, incomes of the poor farmers.

The government should respond through the provision of improved production technology, including seed varieties, farming equipment and appropriate practices. However, poor farmers are often reluctant to adopt new technology, despite its capacity to improve their productivity, even if the technology is provided free of charge. They perceive new technology as being associated with a high risk of production failure.

They are risk averse. As they are poor, they lack the capacity to absorb the cost of production failure, which is possible only by those with sufficient financial wealth to compensate the financial consequences of production loss.

Extended provision of extension service to improve the poor farmer skills in operating new technology would empower the farmers to operate it well. This would lift their confidence in new technology and alter their perception of risk.

Farm credit policy

Farm productivity is another crucial determinant of farming profitability. Higher farm productivity, *ceteris paribus*, generates higher farming profitability. The correct quantity and quality of inputs, including crop variety, are decisive in determining farm productivity. Farmers cannot meet the input requirement themselves, hence cash is needed to buy these inputs from the market.

Farmers are unable to supply this cash fund from their pocket, the government needs to help to overcome this cash problem through the provision of special farm credit schemes for poor farmers. The schemes must be designed to ensure the poor can access the credit and use it profitably.

Poor farmers do not have valuable material properties, other than their small plot of marginal land. Accordingly, they are unable to access any credit if it requires material collateral against default as a standard requirement for granting credit. In addition, the poor farmers are unable to pay interest at commercial rates. Credits should be made available at a special concession interest rate. Such a concession for these marginal farmers is justified since it will be used for farming activities designed to alleviate poverty. The concession can be considered as a necessary input to alleviate rural poverty, not merely as a subsidy.

These special characteristics have to be integrated into the design of credit channelled to the poor farmers. However, their integration into the scheme will make the available credit attractive to a wider range of people. Accordingly, severe competition to obtain access to the scheme could become prevailing. This could end in tragedy with the target group becoming out the scheme's reach, as happened in the credit schemes for rice programmes in many developing countries. The potential of such a tragedy should have been anticipated in the scheme's design.

Such a credit scheme may be also extended to off-farm activities in the context of vertical agricultural diversification. This extension is particularly relevant for groups of poor farmers who organize themselves in the business of vertical agricultural diversification without co-operating with commercial private entrepreneurs or industry.

Land tenancy policy

Poor farmers can better exploit growing market opportunities from the production of secondary food crops if they can expand their farmland operations. This is only feasible if they can obtain extra farmland from land tenancy agreements under favourable tenurial conditions. In reality, poor farmers face great difficulty in accessing the tenancy market because they cannot meet the specified terms. The terms of tenancy are determined by market forces but the forces are against the poor since they are powerless. This is the underlying reason why poor farmers operate only a tiny plot of marginal land, despite a market for tenancy available around them.

This market for land tenancy must be reformed to suit it to the land-hungry poor farmers. Such needs will become even more pronounced when agricultural diversification becomes successful as this will increase competition for land by tenant farmers. This competition will enhance the market power of the rich land-surplus villagers so that tenurial terms will become even more against the interest of the poor farmers. This suggests that the government needs to institute an appropriate land tenancy policy to protect the poor farmers.

Agribusiness partnership policy

The growing market for raw materials of secondary food crops and their derivative products could be exploited further to alleviate rural poverty if poor farmers could develop business partnerships with commercial entrepreneurs or industry. Each can specialize in an activity that they do best. This way, efficiency is enhanced as a result of their positive technical synergy. Therefore, the government should promote the development of such a business partnership through the provision of appropriate public policies.

The policy should provide incentives for this kind of business partnership and can take various forms. One of the options may be an income tax reduction for the commercial private businesses involved. Such a tax reduction could be considered as a corroborating input for the alleviation of rural poverty, not merely as a monetary incentive for large-scale companies to implement strategies to alleviate rural poverty.

2.5 Closing remarks

Vertical agricultural diversification through the development of secondary food crop agriculture has great potential for rural poverty alleviation in developing countries. This potential will grow when vertical and horizontal agricultural diversification are combined. This requires close co-operation between poor farmers specializing in on-farm production and the processing industry.

Chapter 2

Co-operation between poor farmers and the processing industry to exploit the economic potential of secondary food crops can successfully alleviate poverty if the government provides strong support through the provision of a set of appropriate public policies. They include; (i) food diversification policy; (ii) policies promoting the development of a secondary food crop based processing industry; (iii) infrastructure development policy; (iv) farm technology and extension service policy; (v) farm credit policy; (vi) land tenancy policy and (vii) agribusiness partnership policy.

3. Socio-economic Characteristics and the Agricultural Structure of the Participating Countries

*Tomohide Sugino**

This chapter presents a general overview of socio-economic characteristics and agricultural production of the eight participating countries.

3.1 Population

Among the eight participating countries, India has the largest population with 1,064 million people, followed by Indonesia with 215 million people. These two countries are respectively the second and fourth largest countries in the world in terms of population, which make up 20 per cent of the world's population.

Rural population varied from 58 per cent (Indonesia) to 81 per cent (Lao People's Democratic Republic), which reflects that nearly 60 per cent of the total population of Indonesia is concentrated on the small (only 6.7 per cent of the national area) but relatively developed, Java island. On the other hand, Lao People's Democratic Republic is a mountainous and landlocked (or land-connected) country, which is sparsely populated.

Compared to the average composition of the world: 0-14: 29 per cent, 15-65: 64 per cent, 65 and above: 7 per cent, Lao People's Democratic Republic has a relatively younger composition.

Bangladesh is the most densely populated country with a population density of 1,061 per square kilometre, nearly forty times that of Lao People's Democratic Republic (Table 3.1).

* JIRCAS, Japan.

Table 3.1 Population profile of the participating countries

	Bangladesh	India	Indonesia	Lao PDR	Myanmar	Sri Lanka	Thailand	Viet Nam
Population (millions) 2003	138.1	1 064.4	214.7	5.7	49.4	19.2	62.0	81.3
Rural population (per cent) 2000	77	72	58	81	72	79	69	76
Annual growth rate (per cent) 1990-2003	1.7	1.7	1.4	2.4	1.5	1.3	0.8	1.6
Age composition (per cent) 2003								
0-14	35.5	32.4	30.2	41.8	31.9	25.1	22.9	30.6
15-64	61.2	62.5	65.1	54.7	63.6	68.2	70.5	64.1
65+	3.4	5.1	4.7	3.5	4.5	6.7	6.6	5.3
Population density (person/sq km) 2003	1 061	358	119	25	75	298	121	250

Source: World Bank, 2005; FAOSTAT.

3.2 Economic structure

Thailand has the highest income per capita, categorized as 'lower-middle income (\$756-2,995)' by the World Bank, as well as Indonesia and Sri Lanka. The other countries, with the exception of Myanmar for which accurate data is not available, are 'low income (\$755 or less)'.

India has achieved and maintained high and steady economic growth and is the only participating country whose annual GDP growth rate has stood at 5 per cent since the 1980s. Lao People's Democratic Republic, Myanmar and Viet Nam have shown good economic performance recently with growth rates of 6 to 7 per cent per year, despite near stagnation in the 1980s. In contrast, rapid economic growth in Indonesia in the 1980s lost momentum during the Asian economic crisis of 1997-1998. Indonesia has shown a gradual recovery though performance is still far below levels in the 1980s.

Indonesia, Lao People's Democratic Republic and Myanmar are suffering from higher inflation than the other countries, which is indicated by double digit annual growth of the consumer price index.

As for GDP, the contribution of the agricultural sector is only 10 per cent in Thailand, though in terms of employment it is still dominant at around 50 per cent. Agriculture shares

more or less 20 per cent of GDP in Bangladesh, India, Indonesia, Sri Lanka and Viet Nam, while its share in employment is still as large as 50 per cent or more. Although it appears that the industrial sector is a major driving force of the national economy in the five countries, agriculture is still important in terms of employment. In Lao People's Democratic Republic and Myanmar, Agriculture still dominates both the share of GDP and employment (Table 3.2).

3.3 Trade structure

The structure of goods trade is shown in Tables 3.3 and 3.4. The eight participating countries sharply increased both their exports and imports during the last decade. The status of agriculture in trade has become minor both in exports and imports except in Myanmar, where food and agricultural raw materials shared nearly 90 per cent of total exports in 1990.

In Sri Lanka and Thailand, though manufacturing dominate both exports and imports, food exports still earn foreign exchange. Oil and natural gas were replaced by the manufacturers of major export goods in Indonesia. Food, especially rice, imports are still a major concern for food security in Indonesia, increasing in share over the last decade despite the value being much smaller than that of manufacturing.

3.4 Poverty

Asia and the Pacific still account for some 900 million extremely poor rural people. In the participating countries, Bangladesh, India and Lao People's Democratic Republic still have more or less 30 per cent of their respective population below the international poverty line (below \$1 a day), while for other countries, except Myanmar, the ratio is less than 8 per cent. On the other hand, if national poverty lines are applied, poverty is still a serious problem in all the countries. Thailand has the highest gross national income per capita and lowest poverty ratio. However, the Gini index in Thailand is the largest of all the participating countries. This implies that economic development in Thailand has not equally benefited all of the population and poverty is still a significant problem (Table 3.5).

Table 3.2 Income, GDP and employment structure of the participating countries

	Bangladesh	India	Indonesia	Lao PDR	Myanmar	Sri Lanka	Thailand	Viet Nam
Gross national income per capita (\$) 2003 ^a	400	540	810	340	765 or less (Estimated)	930	2 190	48 0
Consumer price index (average annual % growth 1990-2003)	5.0	7.9	13.9	29.7	25.9	9.7	4.1	2.8
Food price index (average annual % growth 1990-2003)	4.7	7.4	16.1	n.a.	27.8	10.1	4.6	n.a.
GDP (current US\$ million) 2003	51 914	600 637	208 312	2 122	n.a.	18 237	142 953	39 164
Annual growth rate of GDP (%)								
1980-1990	3.7	5.7	6.1	3.7	0.6	4.0	7.6	4.6
1990-2003	4.9	5.9	3.5	6.3	7.4	4.7	3.7	7.5
Composition of GDP (%) 2003								
Agriculture	22	22	17	49	57 ^b	19	10	22
Industry	26	27	44	26	11 ^b	26	44	40
Service	52	51	40	25	32 ^b	55	46	38
Employment by agriculture (%) 2000-2002 ^c								
Male	53	n.a.	54 ^d	76 ^d	n.a.	n.a.	50	n.a.
Female	77	n.a.	57 ^d	81 ^d	n.a.	n.a.	48	n.a.

Source: World Bank, 2005.

Note: ^a Calculated using the World Bank Atlas method.

^b 1990.

^c Data is for the most recent year available.

^d Data is for the most recent year available during 1990-1992.

Table 3.3 Structure of goods exports in the participating countries

		Bangladesh	India	Indonesia	Lao PDR	Myanmar	Sri Lanka	Thailand	Viet Nam
Total goods exports (US\$ million)	1990	1 671	17 969	25 675	79	325	1 912	23 068	2 404
	2003	6 942	55 982	60 955	378	2 600	5 125	80 522	20 176
Per cent of GDP	2003	13	9	29	18	n.a.	28	56	52
Food (per cent of total exports)	1990	14	16	11		51	34	29	n.a.
	2003	8	11	11	n.a.	n.a.	21	14	25
Agricultural raw materials (per cent of total exports)	1990	7	4	5		36	6	5	n.a.
	2003	2	1	5	n.a.	n.a.	2	5	2
Fuels (per cent of total exports)	1990	1	3	44		0	1	1	n.a.
	2003	1	6	26	n.a.	n.a.	0	2	21
Ores and metals (per cent of total exports)	1990	n.a.	5	4		2	2	1	n.a.
	2003	0	4	6	n.a.	n.a.	2	1	1
Manufacturing (per cent of total exports)	1990	77	71	35	n.a.	10	54	63	n.a.
	2003	89	77	52	n.a.	n.a.	74	75	50

Source: World Bank, 2005.

Table 3.4 Structure of goods imports in the participating countries

		Bangladesh	India	Indonesia	Lao PDR	Myanmar	Sri Lanka	Thailand	Viet Nam
Total goods exports (US\$ million)	1990	3 618	23 580	21 837	185	270	2 688	33 045	2 752
	2003	9 476	70 707	32 551	524	2 600	6 672	75 809	24 863
Per cent of GDP	2003	18	12	16	25	n.a.	37	53	63
Food (per cent of total exports)	1990	19	3	5		13	19	5	n.a.
	2003	20	6	11	n.a.	n.a.	14	5	6
Agricultural raw materials (per cent of total exports)	1990	5	4	5		1	2	5	n.a.
	2003	7	3	5	n.a.	n.a.	1	3	3
Fuels (per cent of total exports)	1990	16	27	9		5	13	9	n.a.
	2003	8	32	24	n.a.	n.a.	14	12	11
Ores and metals (per cent of total exports)	1990	3	8	4		0	1	4	n.a.
	2003	2	4	3	n.a.	n.a.	2	3	3
Manufacturing (per cent of total exports)	1990	56	51	77		81	65	75	n.a.
	2003	63	54	56	n.a.	n.a.	68	76	76

Source: World Bank, 2005.

Table 3.5 Unemployment and poverty in the participating countries

	Bangladesh	India	Indonesia	Lao PDR	Myanmar	Sri Lanka	Thailand	Viet Nam
Unemployment (Total % of total labour force 2000-2002 ^a)	3.3	n.a.	9.1	n.a.	n.a.	8.7	2.6	n.a.
Population below \$1 a day (%) (Survey year)	36.0 ^b (2000)	34.7 ^b (1999-2000)	7.5 ^b (2002)	26.3 ^b (1997-1998)		7.6 ^b (1999-2000)	<2 ^b (2000)	<2 ^b (2000)
Population below the national poverty line (%) (Survey year)	49.8 (2000)	28.6 (1999-2000)	27.1 (1999)	38.6 (1997-1998)	n.a.	25.0 (1995-1996)	13.1 (1993)	28.9 (2002)
Gini index (Survey year)	31.8 ^c (2000)	32.5 ^c (1999-2000)	34.3 ^c (2002)	37.0 ^c (1997)	n.a.	33.2 ^c (1999-2000)	43.2 ^c (2000)	37.0 ^c (2002)

Source: World Bank, 2005.

Note: ^a Data are for the most recent year available.

^b Expenditure base.

^c Refers to expenditure shares by percentiles of population.

^d Ranked by per capita expenditure.

Table 3.6 Land use in the participating countries

	Bangladesh	India	Indonesia	Lao PDR	Myanmar	Sri Lanka	Thailand	Viet Nam
Total land area (1 000 ha, 2003)	13 017	297 319	181 157	23 080	6 755	6 463	51 089	32 549
Forests and woodland (1 000 ha, 1994)	1 892	68 500	111 774	12 550	32 400	2 100	14 500	9 650
Agricultural area (1 000 ha, 2003) (ha/total population)	9 019 (0.07)	180 804 (0.17)	45 577 (0.21)	1 909 (0.33)	11 293 (0.23)	2 356 (0.12)	18 487 (0.30)	9 622 (0.12)
Arable land (1 000 ha, 2003) (ha/total population)	7 976 (0.06)	160 519 (0.15)	21 000 (0.10)	950 (0.17)	10 093 (0.20)	916 (0.05)	14 133 (0.23)	6 680 (0.08)
Permanent crops (1 000 ha, 2003) (ha/total population)	443 (0.00)	9 220 (0.01)	13 400 (0.06)	81 (0.01)	888 (0.02)	1 000 (0.05)	3 554 (0.06)	2 300 (0.03)
Permanent pasture (1 000 ha, 2003) (ha/total population)	600 (0.00)	11 065 (0.01)	11 177 (0.05)	878 (0.15)	312 (0.01)	440 (0.02)	800 (0.01)	642 (0.01)
Irrigated area (1 000 ha, 2003) (per cent of agr. area)	4 725 (52)	55 808 (31)	4 500 (10)	175 (9)	1 870 (17)	743 (32)	4 986 (27)	3 000 (31)

Source: FAOSTAT.

3.5 Land use

India is the largest in area, though land for agricultural use is limited to less than 0.2 hectares per capita as India has the largest population. The land size of Thailand is less than one-fifth of Indonesia, however, the availability of arable land for annual crop production is the largest at 0.23 hectares per capita. The per capita agricultural land allocation in Bangladesh is the lowest reflecting the highest population density.

As for irrigation, Bangladesh has the highest per cent of irrigated area to total agricultural land reflecting its geographical location in a delta region, followed by Sri Lanka, which is well known for establishing the sophisticated, small tank irrigation system, and Viet Nam, which developed irrigation facilities in its major rice production area of the Red River and Mekong River delta region (Table 3.6).

3.6 Concluding summary

The eight participating countries share a lot of diversity in their demographic character, economic structure, trade structure, conditions of poverty and land use. For example, Bangladesh is the most densely populated country with forty times the population density of Lao People's Democratic Republic. Although it appears that the industrial sector is a major driving force of the national economy in most countries, agriculture is still important in terms of employment. The status of agriculture in trade has become minor both in exports and imports, except in Myanmar where food and agricultural raw materials shared nearly 90 per cent of total exports in 1990. Bangladesh, India and Lao People's Democratic Republic still have more or less 30 per cent of their populations below the international poverty line and poverty is still a serious problem in all the countries when national poverty lines are applied.

Reference

World Bank, 2005. The World Development Indicators 2005,
<http://www.worldbank.org/data/wdi2005>.

4. Historical and Current Status of Secondary Crops and Agricultural Diversification

*Tomohide Sugino**

This chapter presents trends of secondary crop production in Asia and the Pacific including cost-revenue analysis and comparative advantage of crop production. It also introduces the trend of agricultural diversification by calculating the diversification index.

4.1 Trends in area, production and yield of secondary crops

This section focuses on selected Asian and Pacific countries and describes the current situation of secondary crops based on data from FAOSTAT. The scope of the study includes 26 countries in Asia and the Pacific as follows:

- Southeast Asia (eight countries: Cambodia, Indonesia,, Lao People's Democratic Republic, Malaysia, Myanmar, Philippines, Thailand, Viet Nam),
- Far East Asia (five countries: China, Mongolia, Democratic People's Republic of Korea, Republic of Korea, Japan),
- South Asia (six countries: Bangladesh, Bhutan, India, Nepal, Pakistan, Sri Lanka),
- The Pacific (seven countries: Australia, Fiji Islands, New Zealand, Papua New Guinea, Solomon Islands, Tonga, Vanuatu)

In general, the study covers 1979 to 2003 or until the latest year for which data is available. The commodities covered are as follows:

- Coarse grain: Maize, total coarse grains
- Pulses: Soybean, groundnut, total pulses
- Roots and Tubers: Cassava, potato, sweet potato, total roots and tubers.

Harvested area, yield and production are analysed for all crops. Domestic supply, use for feed, food and food processing are analysed for selected secondary crops.

* JIRCAS, Japan.

4.1.1 Trends of secondary crop production and consumption in the region *Production of coarse grains*

Though the harvested area in the region as a whole is shrinking throughout the period, production of total coarse grains is on the rise with occasional fluctuations due to steady improvements in yield. While most coarse grains are minor crops and their production is shrinking, the production of maize is expanding due to rising demand for feed. Greater maize production is ensured through yield increases; similar to total coarse grains (Figure 4.1- 4.6).

Figure 4.1 Harvested area of total coarse grains

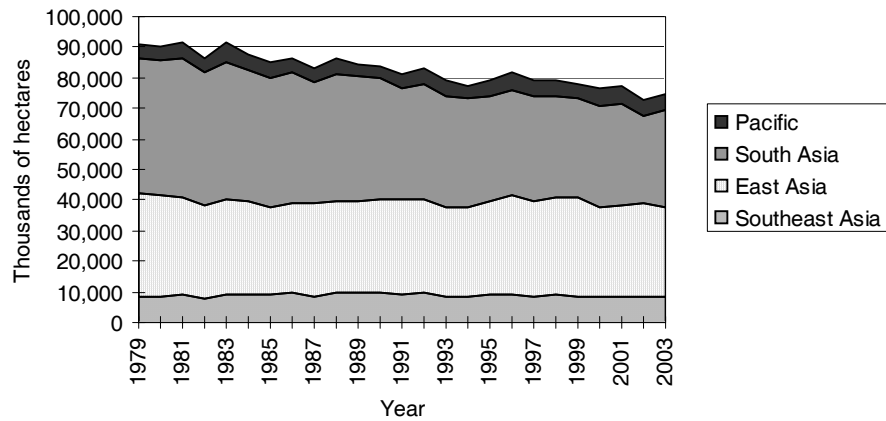

Source: FAOSTAT.

Figure 4.2 Production of total coarse grains

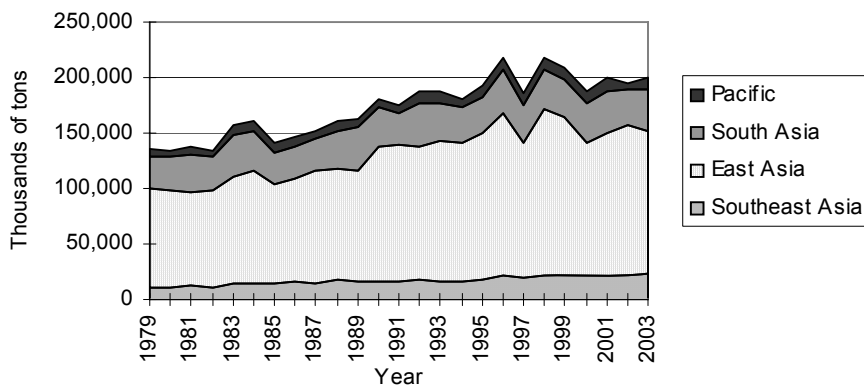

Source: FAOSTAT.

Figure 4.3 Yield of total coarse grains

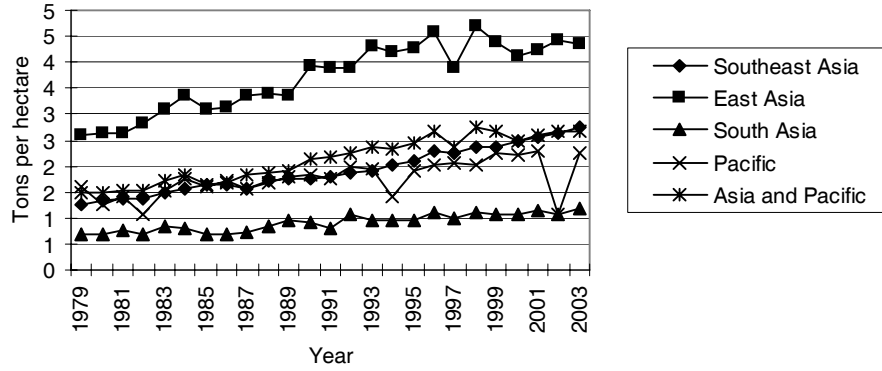

Source: FAOSTAT.

Figure 4.4 Total harvested area of maize in Asia and the Pacific

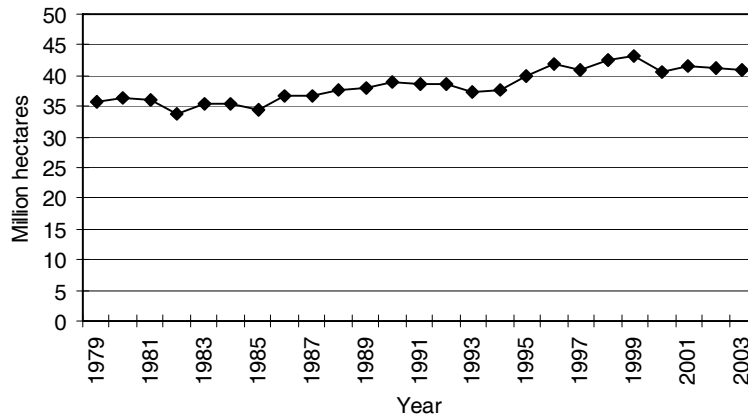

Source: FAOSTAT.

Figure 4.5 Total production of maize in Asia and the Pacific

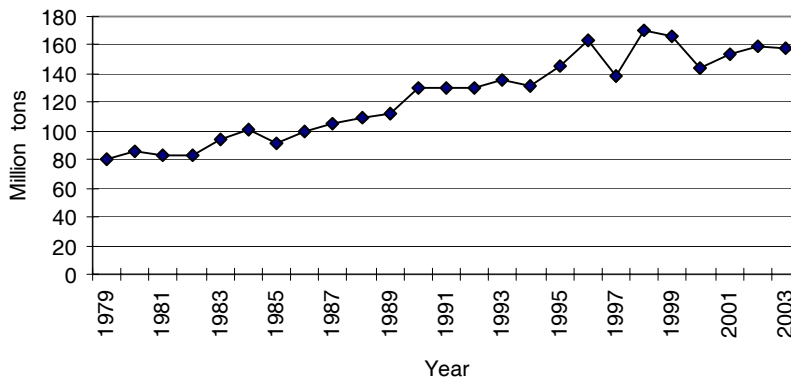

Source: FAOSTAT.

Figure 4.6 Average yield of maize in Asia and the Pacific

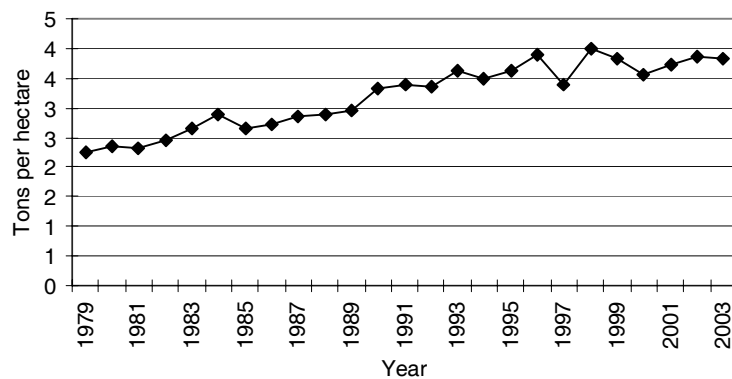

Source: FAOSTAT.

Production of pulses

Harvested area and yield in the region in its entirety is almost constant at around 32 to 35 million hectares and 0.7 tons per hectare respectively. Production is rising gradually but fluctuations are observed year by year. Of the pulses, soybean is one of the most important crops as a source of protein, edible oil and feed. Though the yield of soybean has gradually improved, it is still lower than the other major soybean production areas such as USA and Brazil, which represents the major constraint of soybean production in the region (Figure 4.7-4.15).

Figure 4.7 Harvested area of total pulses

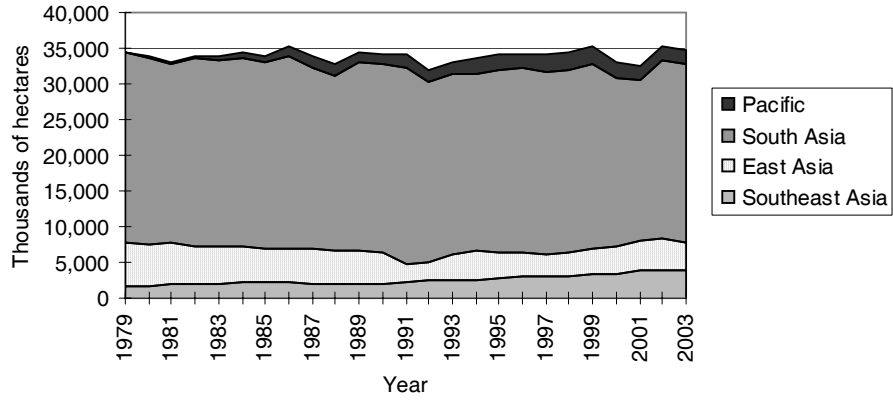

Source: FAOSTAT.

Figure 4.8 Production of total pulses

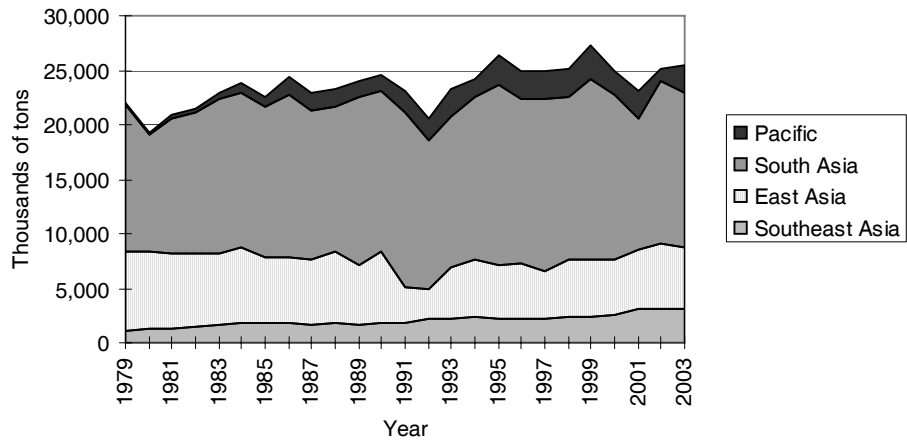

Source: FAOSTAT.

Figure 4.9 Yield of total pulses

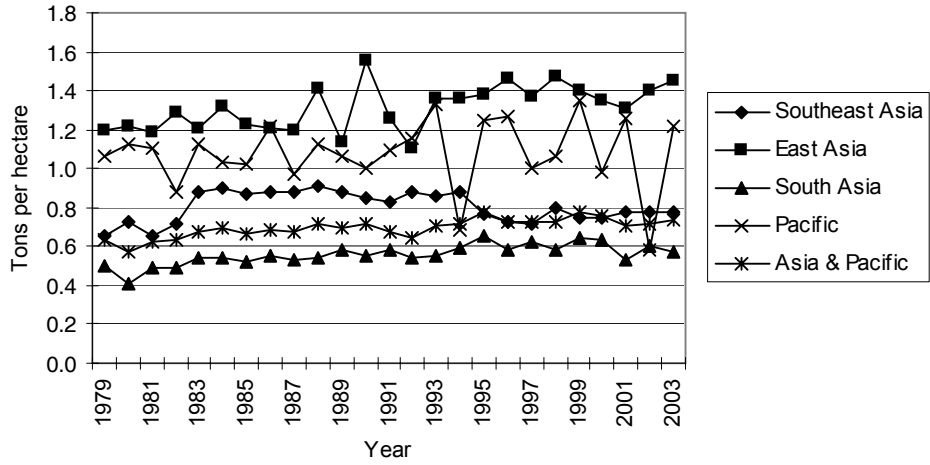

Source: FAOSTAT.

Figure 4.10 Total harvested area of soybean in Asia and the Pacific

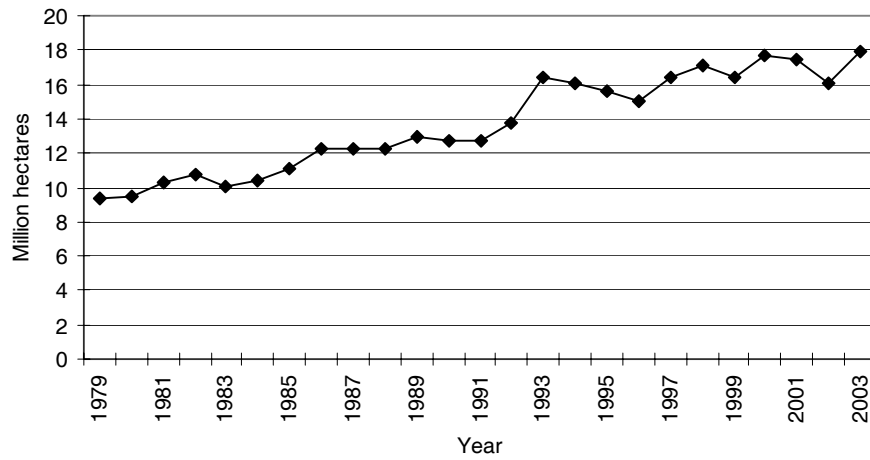

Source: FAOSTAT.

Figure 4.11 Production of soybean in Asia and the Pacific

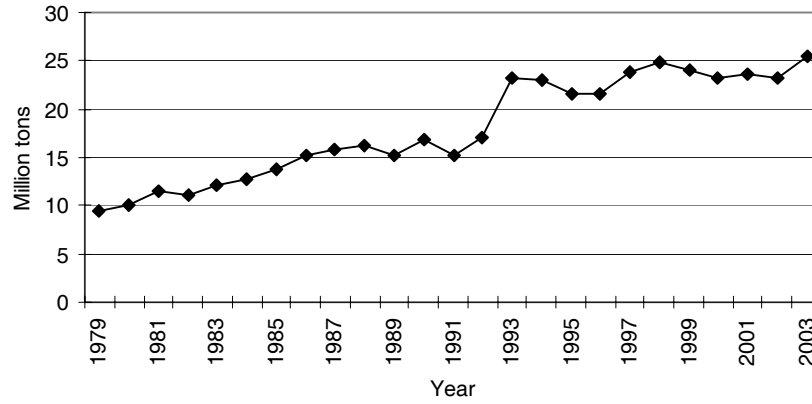

Source: FAOSTAT.

Figure 4.12 Average yield of soybean in Asia and the Pacific

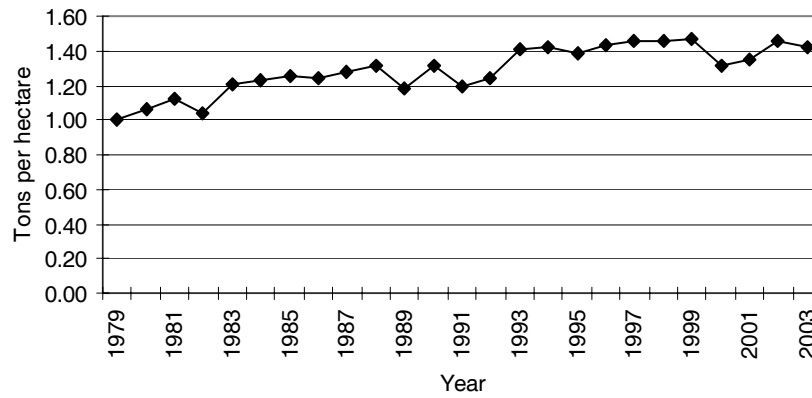

Source: FAOSTAT.

Figure 4.13 Total harvested area of groundnut in Asia and the Pacific

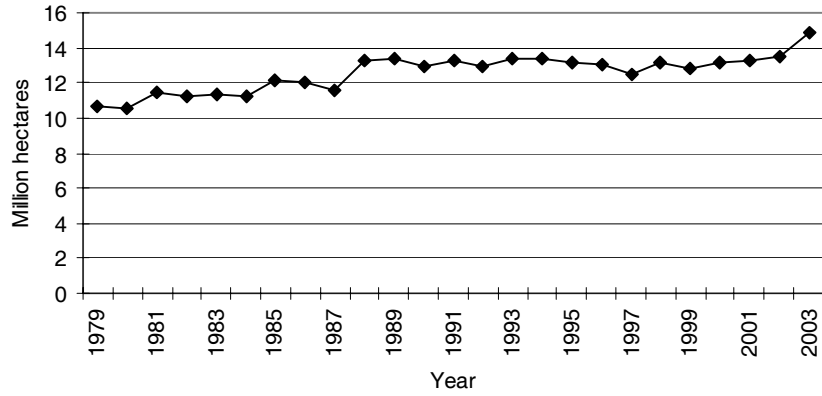

Source: FAOSTAT.

Figure 4.14 Total production of groundnut in Asia and the Pacific

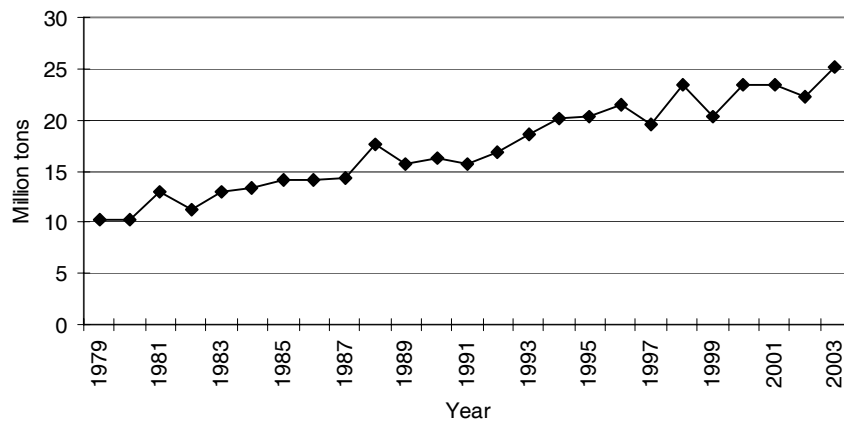

Source: FAOSTAT.

Figure 4.15 Average yield of groundnut in Asia and the Pacific

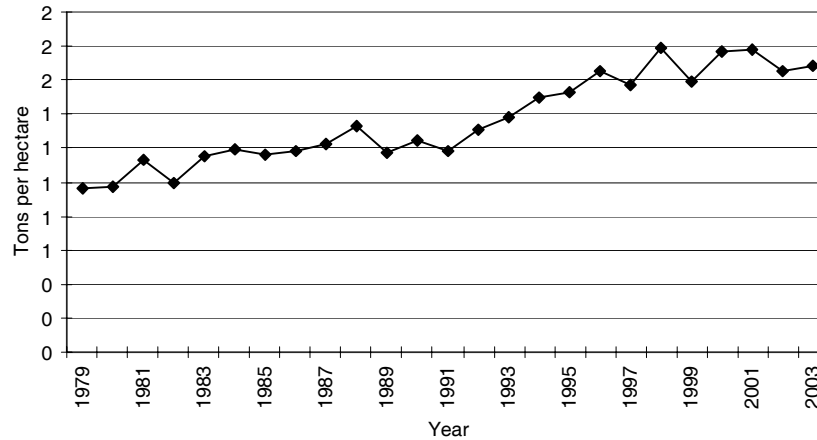

Source: FAOSTAT.

Production of roots and tubers

Total harvested area in the region shrank during the 80s' but gradually increased after the 90s'. Production is now on the rise due to steady improvements in yield. While cassava and potato production have increased recently, production of sweet potato is declining. The production of cassava is expanding due to a steady increase in demand as a source of starch, feed and other industrial raw materials. In line with economic development in the region, dietary patterns are shifting to higher consumption of high-value commodities, including vegetables. This seems to be the major driving force of potato production, since potato is consumed as a vegetable and a staple food. Though various new ways of consuming sweet potato have emerged, such as processed food, most crops are still consumed as staple foods, which seems to result in weak sweet potato production development (Figure 4.16-4.27).

Figure 4.16 Harvested area of total roots and tubers

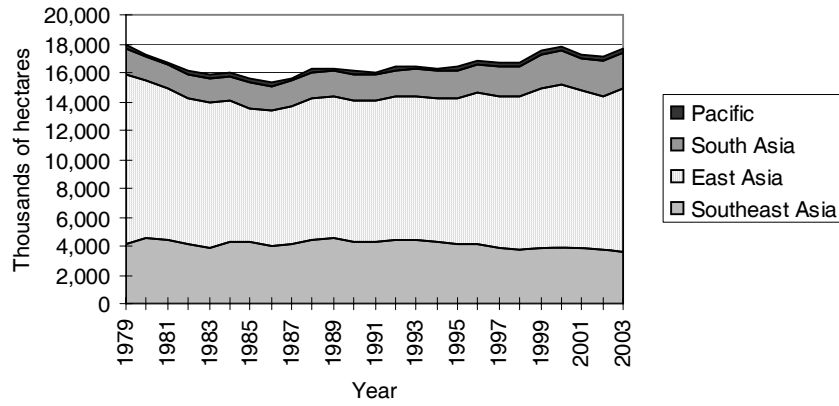

Source: FAOSTAT.

Figure 4.17 Production of total roots and tubers

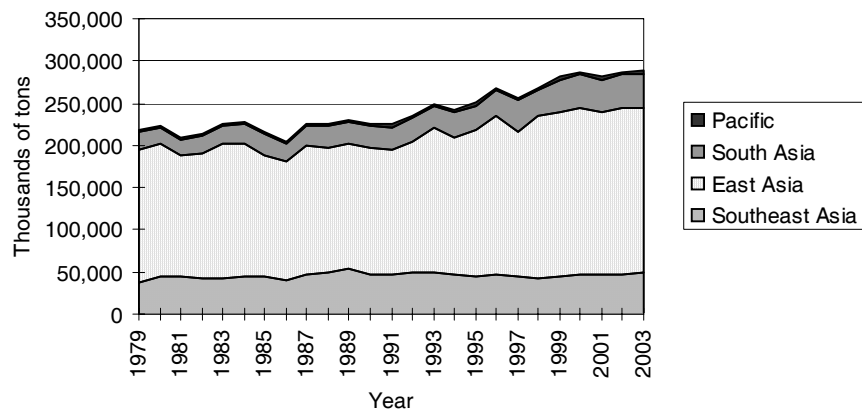

Source: FAOSTAT.

Figure 4.18 Yield of total roots and tubers

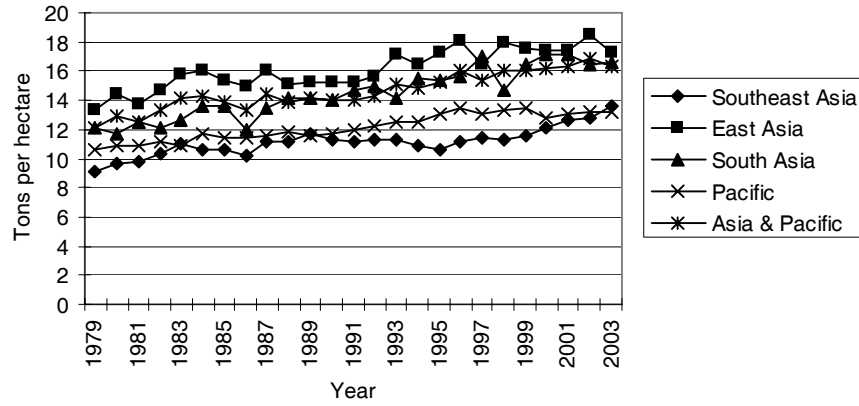

Source: FAOSTAT.

Figure 4.19 Total harvested area of cassava in Asia and the Pacific

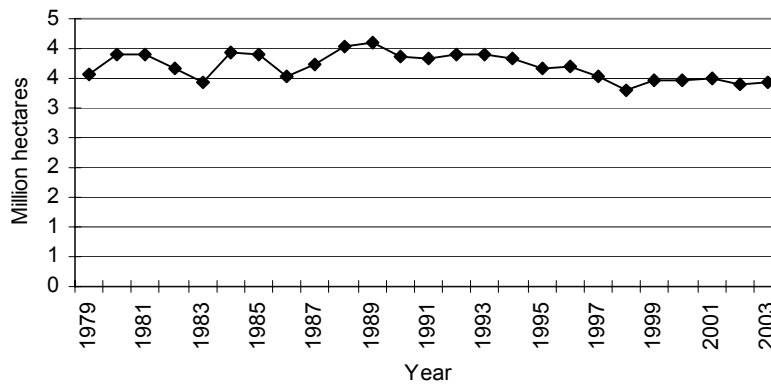

Source: FAOSTAT.

Figure 4.20 Total production of cassava in Asia and the Pacific

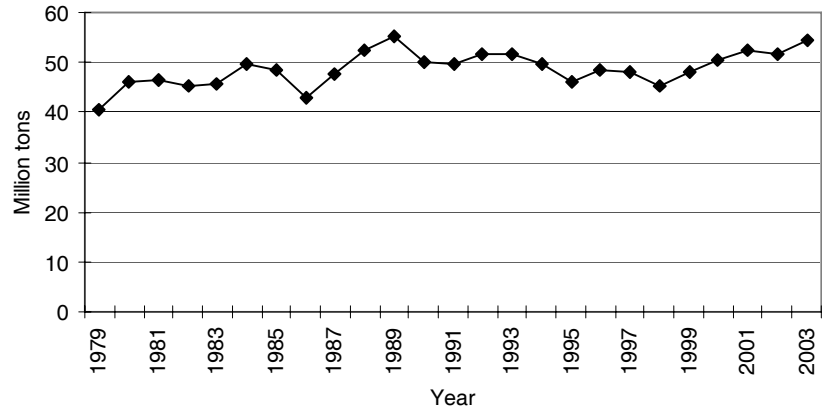

Source: FAOSTAT.

Figure 4.21 Average yield of cassava in Asia and the Pacific

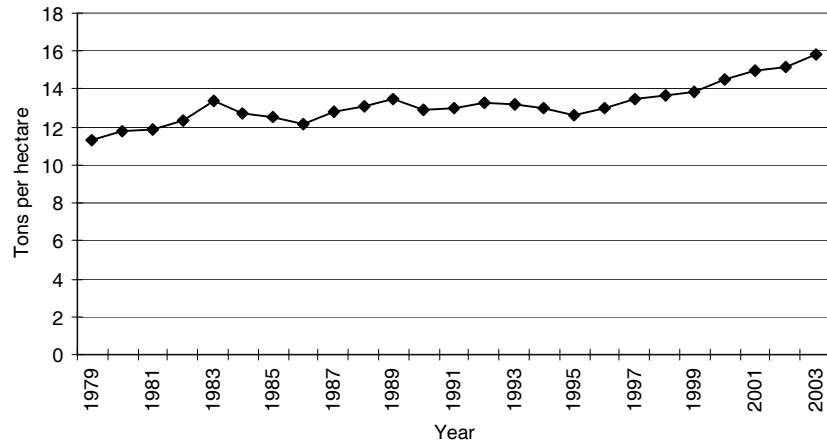

Source: FAOSTAT.

Figure 4.22 Total harvested area of potato in Asia and the Pacific

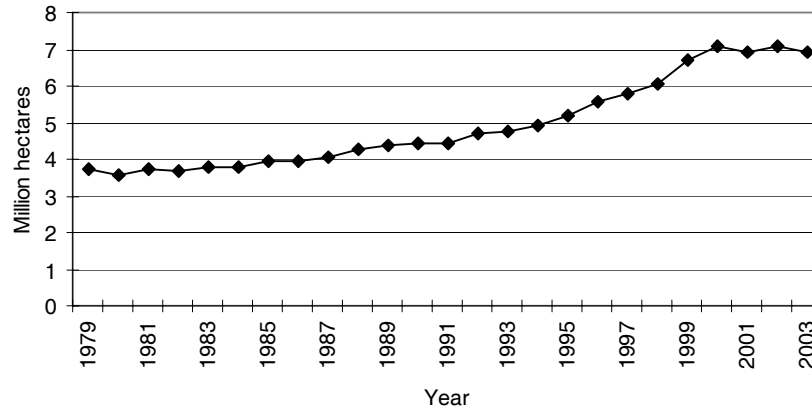

Source: FAOSTAT.

Figure 4.23 Total production of potato in Asia and the Pacific

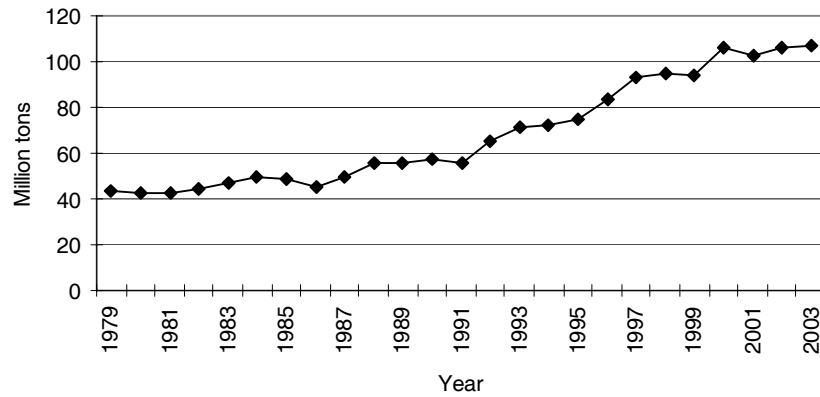

Source: FAOSTAT.

Figure 4.24 Average yield of potato in Asia and the Pacific

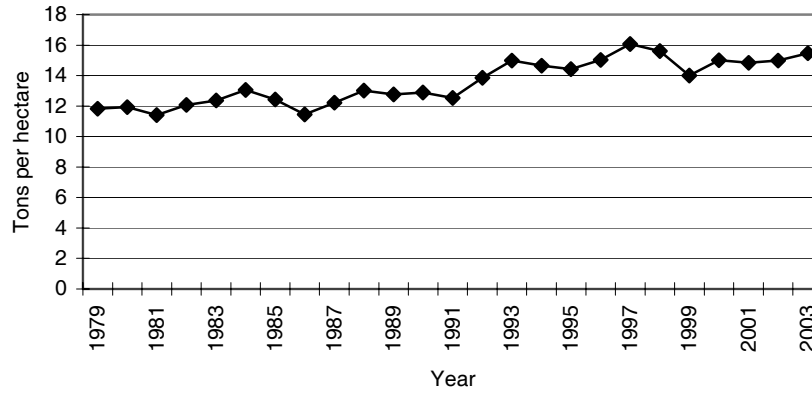

Source: FAOSTAT.

Figure 4.25 Total harvested area of sweet potato in Asia and the Pacific

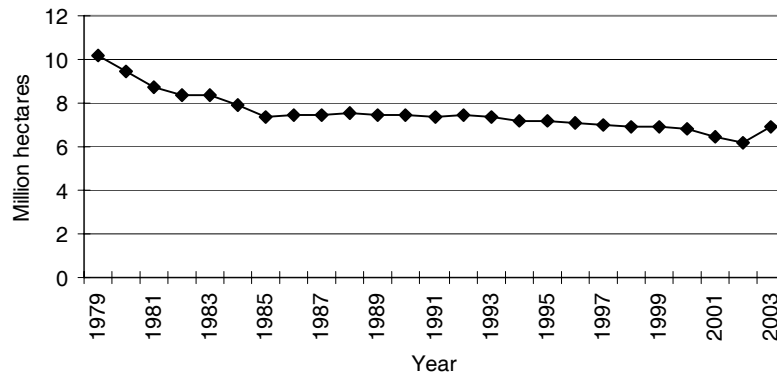

Source: FAOSTAT.

Figure 4.26 Total production of sweet potato in Asia and the Pacific

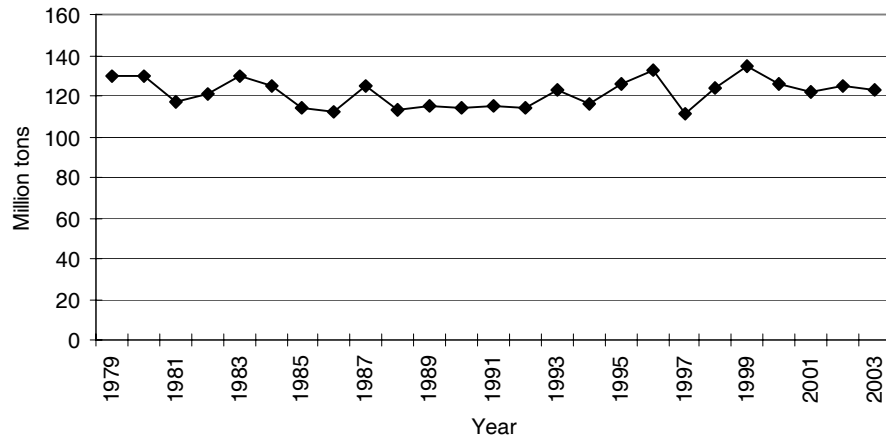

Source: FAOSTAT.

Figure 4.27 Average yield of sweet potato in Asia and the Pacific

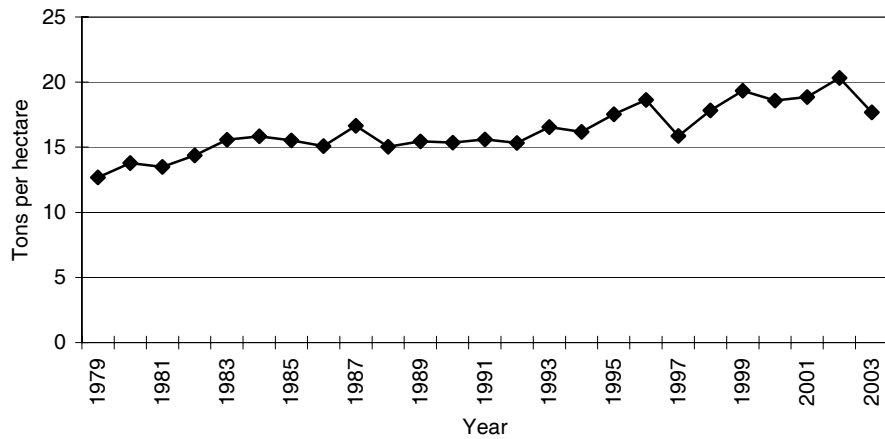

Source: FAOSTAT.

Consumption

Among the major secondary crops, the consumption of maize, soybean, groundnut, cassava and potato is growing steadily (Figures 4.28-4.33). The major influence on consumption is feed (maize, cassava), food processing (soybean, groundnut) and direct consumption as food (groundnut, potato). In addition to the traditional uses of secondary

crops, new ways based on innovative processing technology should be given due attention. Biofuel and bioethanol are considered as environmentally friendly and there is high potential to expand the use of these products. This will be discussed further in Chapter 5.

Figure 4.28 Total consumption of maize in Asia and the Pacific

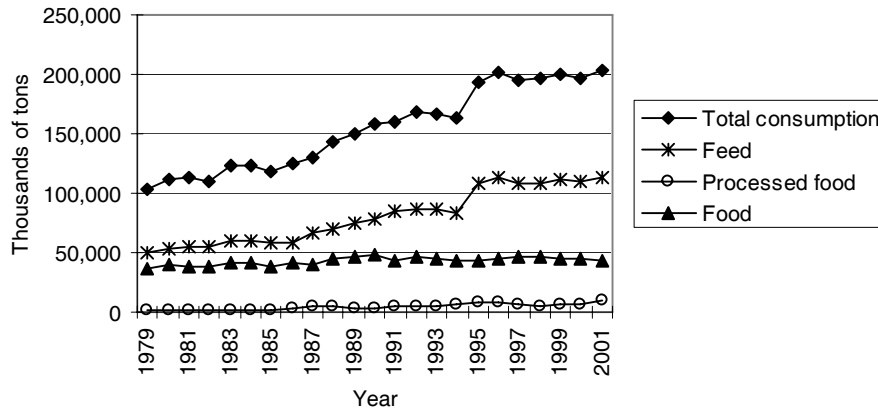

Source: FAOSTAT.

Figure 4.29 Total consumption of soybean in Asia and the Pacific

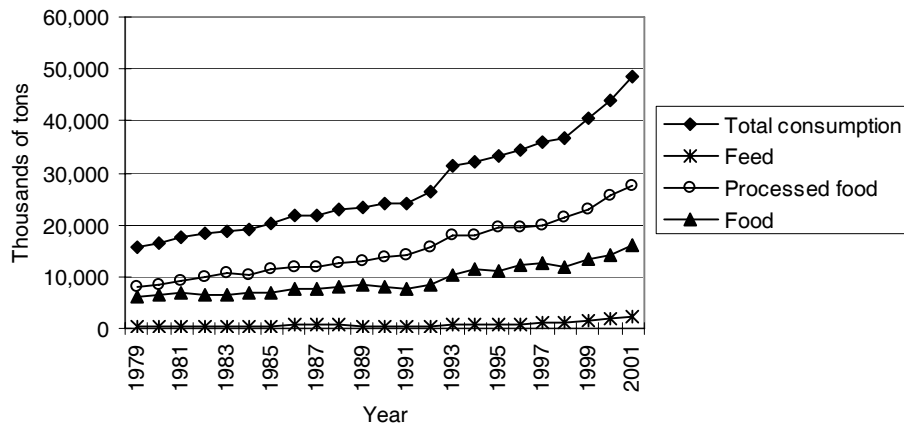

Source: FAOSTAT.

Figure 4.30 Total consumption of groundnut in Asia and the Pacific

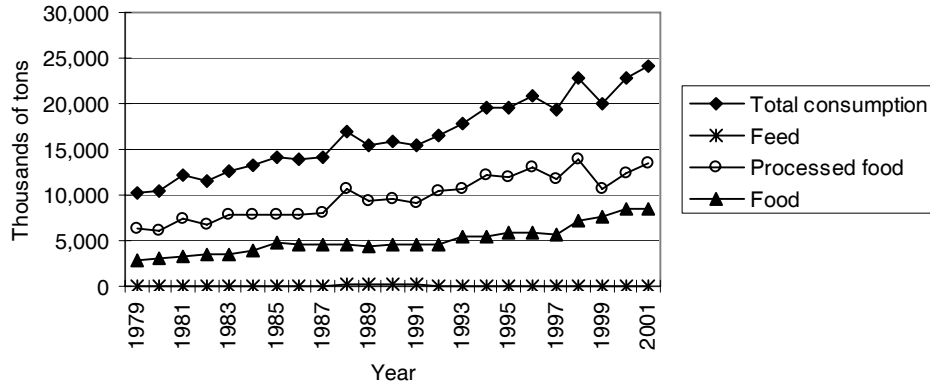

Source: FAOSTAT.

Figure 4.31 Total consumption of cassava in Asia and the Pacific

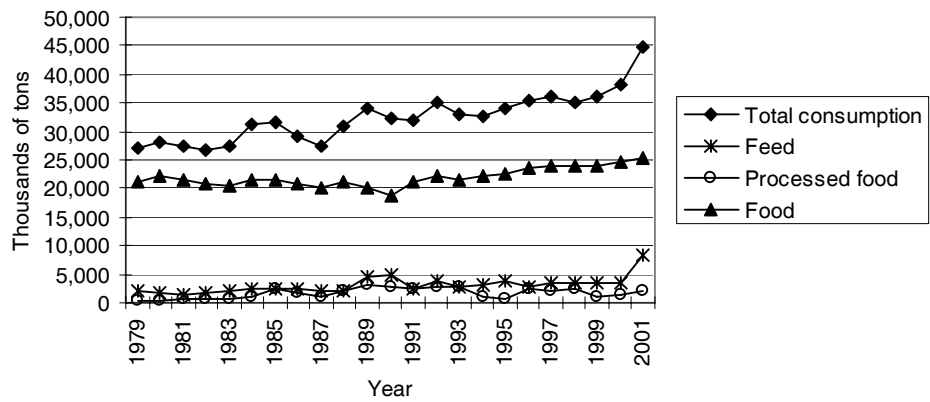

Source: FAOSTAT.

Figure 4.32 Total consumption of potato in Asia and the Pacific

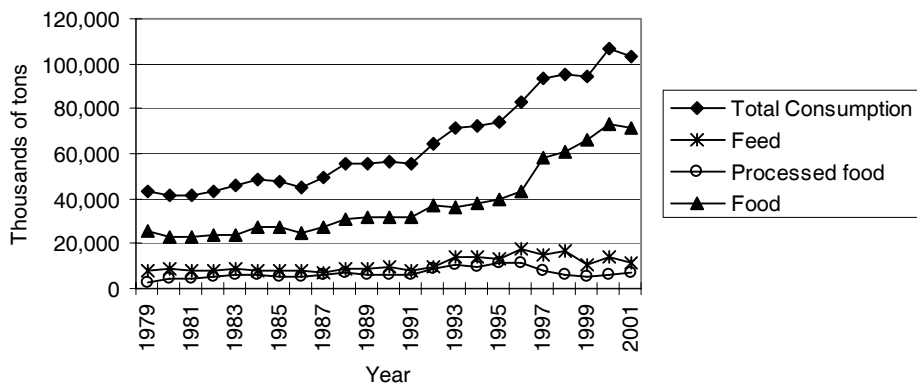

Source: FAOSTAT.

Figure 4.33 Total consumption of sweet potato in Asia and the Pacific

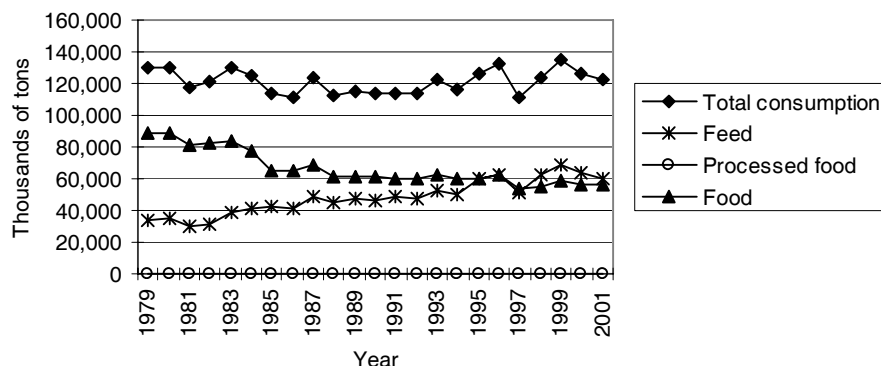

Source: FAOSTAT.

4.2 Cost and revenue of secondary crops

Production costs and the revenue of secondary crops in the participating countries are summarized in Tables 4.1-4.4. Rural surveys were conducted in several countries to investigate the farm household economy during the project period, while other countries collected the information from previous studies due to budgetary limitations. Therefore, it is complex to strictly compare the cost and revenue structure among the participating countries. It should also be noted that cost and revenue depends on the prices of inputs and crops, which are constantly fluctuating and affect farmers significantly.

In spite of these restrictions, we can reach some conclusions from the analysis. The regression functions between production costs and the revenue generated from selected secondary crops are as follows:

Maize : $Y = 1.5317X + 20.0341$, $R = 0.8904$

Soybean : $Y = 0.9635X + 145.3241$, $R = 0.6737$

Green and black gram: $Y = 1.2014X + 49.3174$, $R = 0.9233$

Potato : $Y = 1.7204X - 109.0095$, $R = 0.9875$

Rice : $Y = 0.9322X + 117.9775$, $R = 0.9311$

Where;

$Y =$ Production (US\$/ha), $X =$ Cost (US\$/ha), $R =$ Correlation coefficient

Based on the above functions, the marginal revenue increase per increase in cost for secondary crops is better than rice, if we compare the coefficient of X in each function. This can be used to support the idea that governments should allocate more resources to improve secondary crop production since they can expect higher returns from these inputs than rice.

Table 4.1 Cost and revenue of coarse grain production in the participating countries

Crop	Country	Cost of production (US\$/ha)	Revenue (US\$/ha)	R/C	Remarks
Maize	Bangladesh	433	665	1.53	2003
		617	991	1.61	Bogra & Rangpur, 2004
Maize	India	129	213	1.65	Bihar, Traditional, Kharif, 2004
		127	255	2.00	Bihar, Composite, Kharif, 2004
		144	326	2.26	Bihar, Hybrid, Kharif, 2004
		285	540	1.90	Bihar, Composite, Rabi, 2004
		373	649	1.74	Bihar, Hybrid, Rabi, 2004
		124	152	1.22	Madhya Pradesh, Traditional, Kharif, 2004
		190	266	1.40	Madhya Pradesh, Composite, Kharif, 2004
		232	373	1.60	Madhya Pradesh, Hybrid, Kharif, 2004
		142	287	2.03	Punjab, Traditional, Kharif, 2004
		176	395	2.24	Punjab, Composite, Kharif, 2004
		197	433	2.19	Punjab, Hybrid, Kharif, 2004
Maize	Rajasthan	209	239	1.14	Traditional, Kharif, 2004
		225	364	1.62	Composite, Kharif, 2004

Continued

Table 4.1 Cost and revenue of coarse grain production in the participating countries (continued)

Crop	Country	Cost of production (US\$/ha)	Revenue (US\$/ha)	R/C	Remarks
Maize	India	284	504	1.78	Rajasthan, Hybrid, Kharif, 2004
		376	545	1.45	Rajasthan, Hybrid, Rabi, 2004
		190	263	1.39	Uttar Pradesh, Traditional, Kharif, 2004
		271	490	1.81	Uttar Pradesh, Hybrid, Kharif, 2004
		283	617	2.18	Uttar Pradesh, Hybrid, Rabi, 2004
	Indonesia	317	677	2.13	Rumbia, WS, 2004
	Lao PDR	289	525	1.82	Ban Chum, 2004
	Myanmar	188	255	1.36	Central dry zone, Yezin-hybrid-4, 2003
		166	210	1.26	Hilly region, Yezin-hybrid-3, 2003
		168	195	1.16	Hilly region, HYV, 2003
		261	312	1.20	Hilly region, HYV(CP-888), 2003
	Sri Lanka	261	309	1.19	Anuradhapura, IR, 2002-2003
	Thailand	379	500	1.32	Nakhonratchasima, 2004,
		264	349	1.32	Sukhothai, 2004
		370	473	1.28	Nakhonsawan, IR, 2004
334		421	1.26	Nakhonsawan, RF, 2004	
Viet Nam	334	622	1.86	Hanoi, 2003	
Millet	Bangladesh	125	193	1.55	Proso millet, 2003
		179	232	1.29	Proso millet, Jamalpur, 2004
		123	182	1.48	Foxtail millet, 2003
		168	253	1.50	Foxtail millet, Jamalpur, 2004
	Sri Lanka	295	367	1.24	Finger millet, Anuradhapura, IR, 2002-2003
Sorghum	Thailand	128	178	1.39	Nakhonsawan, 2004

Source: AGRIDIV country studies.

Note: RF = Rainfed, IR = Irrigated, WS = Wet season, DS = Dry season.

Table 4.2 Cost and revenue of pulse production in the participating countries

Crop	Country	Cost of production (US\$/ha)	Revenue (US\$/ha)	R/C	Remarks
Soybean	Myanmar	48	131	2.74	Southern Shan, Rainy season, 2003
		173	274	1.59	Southern Shan, Rainy season, 2003
		191	242	1.27	Mandalay, Rainy season, 2003
		140	237	1.69	Ayeyarwady, 2003
	Sri Lanka	404	603	1.49	Kalawewa, IR, 2001 Yara
		321	437	1.36	Sukhothai, IR, 2003-2004, US\$
	Thailand	338	348	1.03	Sukhothai, RF, 2003-2004, US\$
		261	419	1.61	Nakhonsawan, 2004, US\$
	Viet Nam	165	583	3.54	Hanoi, 2003
	Green gram	Bangladesh	322	484	1.50
291			511	1.76	Faridpur & Pabna, 2004
Myanmar		126	206	1.64	Mandalay, 2003
		95	164	1.73	Mandalay, 2003
		96	175	1.82	Mandalay, 2003
		65	137	2.13	Mandalay, 2003
Sri Lanka		341	402	1.18	Hambantota, RF, 2002-2003
Thailand		154	194	1.26	Nakonratchasima, 2004, US\$
		264	255	0.96	Sukhothai, 2003-4, US\$, drought damaged
		152	301	1.98	Nakhonsawan, 2004, US\$
Black gram	Myanmar	109	175	1.60	Mandalay, Hton-pe ^a , 2003
		71	163	2.31	Ayeyarwady, Hton-pe ^a , 2003
		41	70	1.69	Ayeyarwady, Ye-lite ^a , 2003
		49	85	1.72	Ayeyarwady, Khot-phone ^a , 2003
	Sri Lanka	290	382	1.32	Anuradhapura RF, 2002-03
Groundnut	Sri Lanka	435	465	1.07	Anuradhapura RF
	Viet Nam	492	1 315	2.67	Hanoi, 2003
Lentil	Bangladesh	308	392	1.27	2003
		241	367	1.52	Pabna & Faridpur, 2004

Source: AGRIDIV country study

Note: ^a Hton-pe = Normal practice, Ye-lite = Non-tillage, relay cropping, Khot-phone = Non-tillage, using rice straw as mulch.

RF = Rainfed, IR = Irrigated, WS = Wet season, DS = Dry season

Table 4.3 Cost and revenue of roots and tuber crop production in the participating countries

Crop	Country	Cost of production (US\$/ha)	Revenue (US\$/ha)	R/C	Remarks
Potato	Bangladesh	1 405	2 364	1.68	2003
		1 221	2 753	2.26	Bogra and Munshiganj, 2004
	Myanmar	637	897	1.41	Southern Shan, Rainy season, 2003-2004
		474	619	1.31	Southern Shan, Mid-rainy season, 2003-2004
		925	1 081	1.17	Southern Shan, Summer season, 2002-2003
		Sri Lanka	4 364	7 316	1.68
Viet Nam	1 149	1 710	1.49	Bac Ninh, 2004	
Sweet potato	Bangladesh	495	736	1.49	2003
		460	776	1.69	Jamalpur, 2004
	Viet Nam	262	382	1.46	Hanoi, 2003
Cassava	Indonesia	141	374	2.66	Seputih Banyak, DS, 2004-2005
		153	402	2.63	Rumbia, DS, 2004-2005
	Thailand	405	584	1.44	Nakhonratchasima, 2004
		328	466	1.42	Sukhothai, 2003-204
	Viet Nam	270	806	2.99	Yen Bai, 2001

Source: AGRIDIV country studies.

Note: RF = Rainfed, IR = Irrigated, WS = Wet season, DS = Dry season.

Table 4.4 Cost and revenue of rice production in the participating countries

Crop	Country	Cost of production (US\$/ha)	Revenue (US\$/ ha)	R/C	Remarks
Rice	Indonesia	181	295	1.63	Seputih Banyak, WS, 2004-5
		169	257	1.52	Ayeyarwady, Monsoon rice, 2003
		279	321	1.15	Ayeyarwady, Summer rice, 2003
	Myanmar	177	309	1.75	Mandalay, Monsoon rice, IR, 2003
		145	259	1.79	Mandalay, Monsoon rice, RF, 2003
		169	299	1.77	Mandalay, Summer rice, 2003
		193	286	1.48	Southern Shan, Monsoon rice, 2003
	Sri Lanka	480	545	1.14	Anuradhapura, IR, 2002-3
		262	368	1.40	Nakhonratchasima, 2004
	Thailand	364	521	1.43	Sukhothai, IR, 2003-4
		343	359	1.05	Sukhothai, RF, 2003-4
		421	564	1.34	Nakhonsawan, 2004

Source: AGRIDIV country studies.

4.3 Comparative advantage of secondary crops

Domestic resource cost (DRC) is the sum of total costs of all the domestic resources required to earn an additional dollar of foreign exchange from production of commodity i. In mathematical notion:

$$DRC = \frac{\sum f_{ij} P_j^d}{U_i - \sum a_{ik} P_k^b}$$

(j = 1---m, k = 1----n)

Where;

- f_{ij} = Domestic resources and non-traded inputs j used to produce one unit of commodity i
- P_j^d = Price of non-traded intermediate inputs in domestic currency
- U_i = Border price of output i
- a_{ik} = Amount of traded intermediate inputs for unit production of i
- P_k^b = Border prices of traded intermediate inputs.

If DRC is divided by the exchange rate (V), we can obtain the DRC ratio (DRCR) or

$$DRCR = \frac{DRC}{V}$$

If DRCD is less than 1, it would imply that the output from production activity i is relatively low cost compared with costs in other countries. If the DRCR is more than 1, the opposite would be true.

DRCR of selected secondary crops in participating countries are shown in Tables 4.5-4.7. Since the size of the sample is very limited, it is difficult to make a general conclusion from the table, however, several implications can be drawn.

4.3.1 Maize

Bangladesh, Indonesia and Myanmar have comparative advantage (DRCR < 1) nationwide. On the other hand, Sri Lanka has comparative disadvantage in maize production. In Viet Nam, most study sites have comparative advantage, while one site showed comparative disadvantage.

4.3.2 Soybean

Indonesia has comparative advantage at most study sites. Other than Indonesia, most study sites do not have comparative advantage reflecting the low yield level. Thailand

has comparative disadvantage at both sites. In Viet Nam, most study sites show comparative disadvantage, while one site has comparative advantage.

4.3.3 Potato

Bangladesh and Indonesia have comparative advantage in potato production. Especially in Bangladesh, DRCR is extremely low, which shows its strong competitiveness in potato production.

Competitiveness of crop production is usually site specific. As the study results have shown, some areas have comparative advantage of a specific commodity, while other areas show less competitiveness. Therefore, policy support for secondary crop development should reflect local conditions which affect crop production competitiveness. In the areas with better comparative advantage, policies should focus on promoting the production of specific crops to exploit the opportunities. On the other hand, for the areas with comparative disadvantage, policies which simply promote crop production may not be sufficient to improve the economic conditions of farmers. Value adding or diversification of cropping patterns that introduce new commodities with better competitiveness will be more useful in such areas.

Table 4.5 DRCR of secondary crops in the AGRIDIV countries (coarse grains)

Crop	Country	DRCR	Remarks	
Maize	Bangladesh	0.639	1990s and after	
		Indonesia	0.37	Kediri, Irrigated, DS-I, 2001
		0.49	Kediri, Irrigated, DS-II, 2001	
		0.38	Kediri, Simple-irrigated, DS-I, 2001	
		0.43	Kediri, Simple-irrigated, DS-II, 2001	
		0.39	Kediri, Rainfed, DS-I, 2001	
		0.48	Kediri, Rainfed, DS-II, 2001	
		0.65	Sidrap, Semi-irrigated, DS-II, 2001	
		0.56	Sidrap, Simple-irrigated, DS-II, 2001	
		0.58	Sidrap, Rainfed, DS-II, 2001	
	Myanmar	0.43	2001	
	Sri Lanka	1.24	<i>Maha</i> 2002/03	
	Viet Nam		0.78	Son La, 2003
			1.09	Ha Tay, 2003
		0.78	Dac Lak, 2003	
		0.99	Dong Nai, 2003	
Millets	Bangladesh	0.491	1990s and after	
		Sri Lanka	1.92	Finger millet, <i>maha</i> 2002/03
		1.29	Finger millet, <i>yala</i> 2002	

Data source: AGRIDIV country study reports.

Note: WS = Wet season, DS = Dry season.

Table 4.6 DRCR of secondary crops in the AGRIDIV countries (pulses)

Crop	Country	DRCR	Remarks
Soybean	Indonesia	0.92	Klaten, Irrigated, DS-II, 2001
		0.99	Klaten, Rainfed, DS-II
		0.88	Ngawi, Semi-irrigated, DS-II, 2001
		1.15	Ngawi, Simple-irrigated, DS-II, 2001
		0.75	Ngawi, Rainfed, DS-I, 2001
		0.94	Ngawi, Rainfed, DS-II, 2001
	Thailand	1.454	Phitsanulok, 1992/93
		1.204	Nakhonsawan, 1992/93
	Viet Nam	1.17	Son La, 2003
		1.3	Ha Tay, 2003
		0.98	Dac Lak, 2003
1.13		Dong Nai, 2003	
Groundnut	Indonesia	0.6	Klaten, Irrigated, DS-II, 2001
		0.59	Klaten, Rainfed, DS-II, 2001
		0.57	Sidrap, Semi-irrigated, DS-I, 2001
		0.63	Sidrap, Semi-irrigated, DS-II, 2001
		0.62	Sidrap, Rainfed, DS-II, 2001
		0.97	Agam, irrigated WS, 2001
	Sri Lanka	1.85	<i>Maha</i> 2002/03
Black gram	Myanmar	0.55	Hinthata (Delta)
		0.19	Pyinmana (Dry zone)
	Sri Lanka	1.44	<i>Yala</i> 2003
Green gram	Myanmar	0.74	Thonegwa (Delta)
		0.65	Magway (dry zone)
	Sri Lanka	0.56	<i>Yala</i> 2003
	Thailand	1.162	Phitsanulok, 1992/93
		1.811	Nakhonsawan, 1992/93
Lentil	Bangladesh	0.615	1990s and after

Source: AGRIDIV country study reports.

Note: WS = Wet season, DS = Dry season.

Table 4.7 DRCR of secondary crops in the AGRIDIV countries (root and tuber)

Crop	Country	DRCR	Remark
Potato	Bangladesh	0.147	1990s and after
	Indonesia	0.506	Wonosobo, WS, 2001
		0.339	Wonosobo, DS, 2001
		0.881	Tanah Karo, WS, 2001
		0.768	Tanah Karo, DS, 2001
Cassava	Sri Lanka	0.51	<i>Maha</i> 2001/02

Source: AGRIDIV country study reports.

Note: WS = Wet season, DS = Dry season.

4.4 Trends of agricultural diversification

Agricultural diversification is classified into horizontal and vertical diversification in terms of the direction to which the farm economy proceeds. Horizontal agricultural diversification involves diverse activities undertaken within the farm production unit, whereas vertical diversification involves income-earning activities undertaken off-farm (Taylor, 1994).

The major concept of horizontal diversification is to raise the number of crops in the fields as long as it is economically rational. Various indices have been proposed in previous studies for the quantification of the degree of horizontal diversification. In the regional study of AGRIDIV, Simpson Index (SID) at the country level was calculated.

4.4.1 Simpson Index (SID) of crop groups by harvested area

Simpson Index (SID) is defined as follows:

$$SID = \frac{1}{\sum_{i=1}^n W_i^2}, \quad W_i = X_i / (\sum X_i)$$

Where X_i is the value or area of the i th commodity and W_i is the proportionate value or area of the i th commodity in the total value or area. The minimum value of SID is 0 (the least diversified) whereas the maximum value is 1 (the most diversified).

In the regional study of AGRIDIV, SID of the participating countries is calculated from the harvested area of ten crop groups, namely (i) rice; (ii) wheat; (iii) coarse grains; (iv) roots and tuber crops; (v) pulses; (vi) oil crops; (vii) vegetables; (viii) fruits and nuts; (ix) spices and amenities of life (coffee, tea tobacco, etc.); and (x) rubber and textiles.

SID becomes larger the greater the number of crops cultivated. This means the availability of data affects SID, especially when we calculate at a regional or country level, rather than the farm level. The major objective of the calculation is to overview the current status of diversification at the country level and compare this among the participating countries. Therefore, we adopted crop groups, not individual crops as the basis of calculation because the number of crops with sufficient statistical data is different in each country. SID has also been calculated in the respective AGRIDIV country study reports. Due to the reasons mentioned, the tendency of SID is not exactly same as the conclusion of this report since the crops or the category of crop groups used are different from the ones adopted in this report.

Table 4.8 shows the results of calculating SID. In addition to the participating countries, the SID of East and Southeast Asia as well as South Asia are shown. SID was

calculated for every five years during 1980 to 2000. A three year average was used to avoid the effects of annual harvest change caused by crop failure. For example, SID in 1980 is calculated based on the average harvested area in 1979, 1980 and 1981.

4.4.2 SID trend

Table 4.8 shows that the eight participating countries can be classified into three groups according to their value of SID.

- Group 1 (High SID countries): India, Indonesia, Sri Lanka
- Group 2 (Middle SID countries): Myanmar, Thailand, Viet Nam
- Group 3 (Low SID countries): Bangladesh, Lao People's Democratic Republic

Table 4.8 Recent trend of SID in selected years

Country or Region \ Year	1980	1985	1990	1995	2000
Bangladesh	0.4434	0.4621	0.4363	0.4485	0.4446
India	0.8329	0.8376	0.8393	0.8413	0.8443
Indonesia	0.7666	0.7712	0.7778	0.7867	0.7789
Lao PDR	0.2647	0.3031	0.3883	0.4114	0.4636
Myanmar	0.6283	0.6646	0.6453	0.6630	0.7003
Sri Lanka	0.7717	0.7709	0.7791	0.7635	0.7547
Thailand	0.6541	0.6745	0.6893	0.6824	0.6437
Viet Nam	0.5232	0.5574	0.5666	0.5829	0.6017
East and Southeast Asia	0.7399	0.7515	0.7560	0.7555	0.7505
South Asia	0.8309	0.8336	0.8356	0.8370	0.8382

Data source: Calculation from FAOSTAT data.

During the period of 1980-2000, SID of Group 1 was always above 0.75, whereas the SID of Group 3 was below 0.5.

The key findings regarding changes in SID are as follows:

- The most remarkable increase in SID was seen in Lao People's Democratic Republic, which continuously increased from 0.2647 (1980) to 0.4636 (2000).
- SID of Bangladesh was stable with small fluctuations between 0.4363 - 0.4621.
- Among the high SID countries, Indonesia and Sri Lanka witnessed a decline in their respective SID meanwhile in India it slightly increased.
- As a region, East and Southeast Asia have seen their SID fall (from 0.7560 to 0.7505), meanwhile an increase has been observed in South Asia (from 0.8356 to 0.8382).

Previous studies have shown that major determinants of agricultural diversification away from staple food production are crop prices, market access, development of technology, climate change, the global economic environment, per capita income, policy

and institutional arrangements, etc. Further discussion will be necessary to clarify which factor most affects and explains the difference and trend of SID at the national level.

It should be noted that agricultural diversification is very site specific. SID at the national level can describe only a small part of the current status of agricultural diversification. A high SID value does not necessarily mean that there is little potential for further diversification. Moreover, SID has no relationship with profitability of farming system. However it can be concluded that the trends of national level SID will provide a crude gauge of current status of horizontal diversification in each country.

4.5 Impact of diversified agricultural systems on the environment in the region

A plethora of literature mentions the positive impacts of agricultural diversification on the environment. However, very few studies have been implemented to measure their affect quantitatively. One of the reasons is the complexity how the effect is achieved. In this section the negative effects of intensified agriculture on the environment and how agricultural diversification works to restore a damaged environment will be described. Then, we introduce a valuation method for the environment and focus on the quantification of effects, especially on genetic resource preservation.

4.5.1 The impact of intensified agriculture on environmental degradation

High-yielding varieties of major cereals formed the foundation of the 'Green Revolution' and contributed dramatically to expanding major crop production in many developing regions. However, the top-down system of agricultural policies, where farmers were seen merely as recipients of policies rather than as participants to the policy-making process, has contributed to an increased dependence on relatively few major crops.

Side effects of intensified agriculture are include the following:

- Pollution by excess synthetic chemicals

High-yielding varieties generally require more intensive inputs rather than traditional varieties. Excessive chemical fertilizers and pesticides, in an attempt to maximize yields, may cause leaching of excess synthetic chemicals into the soil and ground water below, as well as the run-off of excess chemicals into surface water.

- Decline in soil productivity
If the cultivation of one specific crop is continued, loss of micronutrients particular to the specific crop and/or more disease causing microorganism trigger a decrease in crop yield.
- A loss of agro-biodiversity
Out of the roughly quarter-of-a-million plant varieties available to agriculture, only about 7,000 or less than 3 per cent are in use today (FAO, 1998). The less used varieties become extinct if an appropriate conservation project is not implemented. Intensified agriculture is partly responsible for genetic erosion as well as deforestation and urbanization.

4.5.2 Role of agricultural diversification in overcoming environmental deterioration

The impact of agriculture diversification on the environment is wide ranging and primarily attributable to horizontal diversification at the household level.

- Improve soil fertility
Diversified cropping systems at the household level like crop rotation, intercropping and relay cropping improve soil fertility, especially in systems including legume cultivation which induces out nitrogen fixation. They also prevent excessive exploitation of specific micronutrient elements by particular crops. Integration between field crops and livestock is also useful for preserving soil fertility due to the manure produced by livestock.
- Reduce plant pests
Diversified cropping patterns in the field bring natural defenses against weeds, insects and disease. Crop rotation prevents particular plant pests from exploding their population by breaking their life cycle.
- Maintaining agro-biodiversity
Conservation projects for agricultural genetic resources include *ex-situ* and *in-situ* preservation. *Ex-situ* conservation is the conservation of a plant outside of its original or natural habitat, such as in a gene bank or botanical garden. *In-situ* conservation is the conservation of plants or animals in areas where they developed their distinctive properties: in the wild or in farmers' fields (Vernooy, 2003). Agricultural diversification can work as *in-situ* conservation if farmers can maintain indigenous crop varieties in their fields.

4.5.3 Valuation method for the environment

Environmental valuation methods used in environmental economics fall into two broad categories of revealed preference (or indirect) methods (RPM) and stated preference (direct) methods (SPM). RPM include hedonic pricing and travel cost methods, in which prices in markets related to the environmental good or in which the good is implicitly traded serve as proxies. SPM include contingent valuation (CV) and attribute-based choice modelling (ABCM), in which values are elicited from respondents using survey techniques (Birol, 2002).

Another way of quantifying the multi-functionality of agriculture is the alternative method. Examples of alternative methods include evaluation on the water storing function of agricultural fields or forest by converting it to a function of dams.

Previous studies have revealed the environmental value of multi functionality. For example, the economic value of water storing and flood prevention of farm land in Japan is evaluated as 4,962 billion yen (US\$ 45 billion) (Science Council of Japan, 2001). However, qualification of the impacts of agricultural diversification is very difficult because diversification is one component of agricultural multi-functionality and most of its effects cannot be identified independently.

Figure 4.34 Most commonly used environmental valuation methods

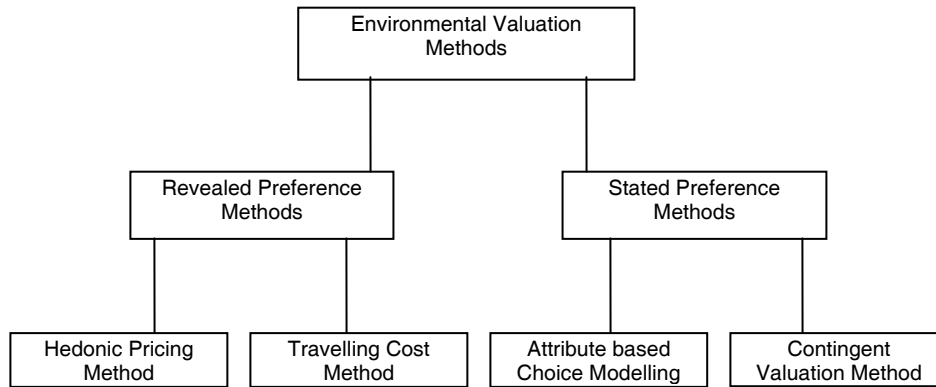

Source: Birol, 2002.

4.5.4 Impact on agro-biodiversity

Out of the various impacts of agricultural diversification, we would like to focus on agro-biodiversity because of the multi-functionality in agriculture, agro-biodiversity is thought to be acquired mainly through agricultural diversification, especially farm level horizontal diversification.

Preventing genetic erosion is important to ensure future crop breeding. Agricultural diversification at the farm level will contribute to *in-situ* genetic conservation. SID is the index which shows the status of horizontal agricultural diversification. SID simultaneously shows the status of agro-biodiversity at the species level and is supposed to have strong linkage with agro-biodiversity at the varietal level, which is more significant in the context of agro-biodiversity conservation. Investigating the coefficient of correlation between SID and number of varieties for agricultural production will provide useful suggestions.

Estimates of the global value associated with the use of plant genetic resources for food and agriculture vary from hundreds of millions to tens of billions of dollars per year (FAO, 1998). Thus it is reasonable to conclude that the economic value of agricultural diversification in the context of agro-biodiversity is huge and it should be promoted through public institutional support because biodiversity is a public good and private efforts are insufficient to provide effective measures to conserve it.

4.6 Concluding summary

Though the harvested area of most secondary crops is stable or shrinking, production is on the rise due to gradual improvements in yield. The consumption of maize, soybean, groundnut, cassava and potato is growing steadily. The major factor promoting consumption is feed (maize, cassava), food processing (soybean, groundnut) and direct consumption as food (groundnut, potato). The marginal revenue increase per increase in cost for secondary crops is better than for rice, which can be used to support the idea of promoting secondary crop production. Many areas have comparative advantage for a specific secondary crop, while other areas show less competitiveness. The most remarkable increase of SID was reported in Lao People's Democratic Republic.

Reference

Birol, Ekin, 2002. Applying Environmental Valuation Methods to Support the Conservation of Agricultural Biodiversity. The Economics of Conserving Agricultural Biodiversity on-Farm. Proceedings of a workshop hosted by the Institute for Agrobotany (IA), Hungary, and the International Plant Genetic Resources Institute (IPGRI), Italy, Gödöllo, Hungary, May 13-16, 2002.

FAO, 1998. The State of the World's Plant Genetic Resources for Food and Agriculture.

FAOSTAT: <http://faostat.fao.org/default.jsp>.

Chapter 4

- Smale, Melinda *et al.*, 2002. The Economics of Conserving Agricultural Biodiversity on-Farm. Proceedings of a workshop hosted by the Institute for Agrobotany (IA), Hungary, and the International Plant Genetic Resources Institute (IPGRI), Italy, Gödöllo, Hungary, May 13-16, 2002.
- Vernooy, Ronnie, 2003. Seeds that Gives: Participatory Plant Breeding. Canada: International Development Research Centre (IDRC).
- Science Council of Japan, 2001. Chikyu-kankyo, ningen-seikatu ni kakawaru nougyo oyobi sinrin no tamentekina kino no hyouka nituite (Evaluation of multi functionality of agriculture and forest concerning global environment and human life), Japan.
- Taylor, D., 1994. Agricultural Diversification in Southeast Asia, Agricultural Diversification in Monsoon Areas. Asian Productivity Organization.

5. Prospects of Industrial Uses of Secondary Crops

Tomohide Sugino*

The ratio of the amount of secondary crops directly consumed as food in Asia and the Pacific has decreased continuously for two decades (Figure 5.1). This trend indicates that though the role of secondary crops is still important for poor people in disadvantaged areas, the importance of these crops as staple foods is diminishing due to the expansion of rice production and economic development in the region have made access to major cereals easier.

Figure 5.1 Ratio of secondary crop consumption as food in Asia and the Pacific

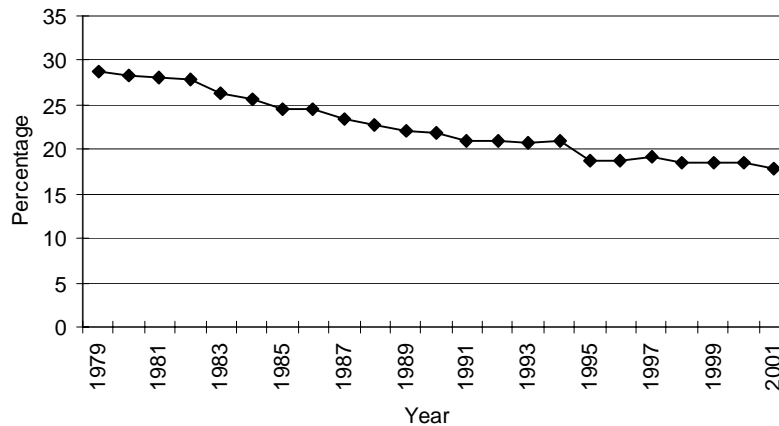

Source: Calculated by the author based on FAOSTAT.

Note: Calculated by the commodity balance data on maize, groundnut, soybean, cassava and sweet potato.

In spite of this trend, the production of secondary crops is still expanding due to higher use as raw materials for industry. It is well-known that these crops are widely used for processed food, local snacks, starch and edible oil. In addition to 'traditional' processing, 'modern' processing using innovative technology is stimulating secondary crop

* JIRCAS, Japan.

consumption. In this chapter, the current status and future prosperity of secondary crops in agro-industry, both for 'traditional' and 'modern' processing will be discussed.

5.1 Trends of secondary crop food processing in the region

In this section, traditional processing of secondary crops will be presented. Among the major secondary crop products, we describe the trends of oil from maize and soybean as well as beer from barley in the region to understand the current status of food processing using secondary crops. The scope of study is the same as section 4.1 (Historical review and analysis of agricultural production and consumption in Asia and the Pacific).

5.1.1 Maize oil

Production of maize oil increased almost constantly during 1979 to 1994, reaching around 236,000 tons. In 1995, production plummeted and thereafter fluctuates between 214 to 228 tons (Figure 5.2). The main consumers of maize oil have common characteristics such as a significant urban population and the highest HDI (Human Development Index) of the ESCAP countries (Bourgeois and Balerin, 2004)

Figure 5.2 Production of maize oil

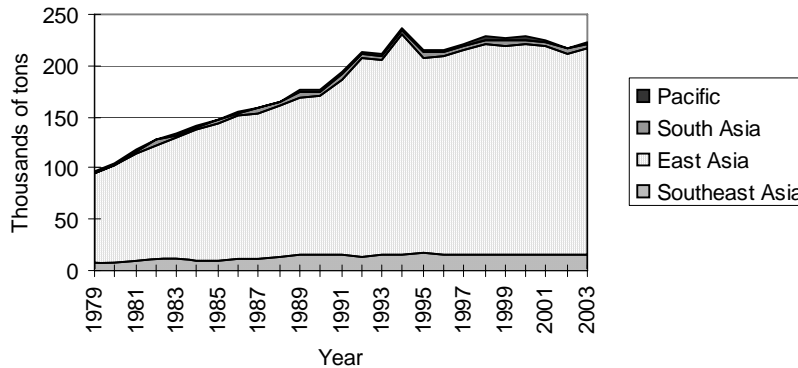

Source: FAOSTAT.

5.1.2 Soybean oil

Production of soybean oil increased almost constantly from 1979 to 2001, reaching around 4,622,000 tons. In 2002, production eased off temporarily but in 2003, it rebounded to the same level as 2001 (Figure 5.3).

Figure 5.3 Production of soybean oil

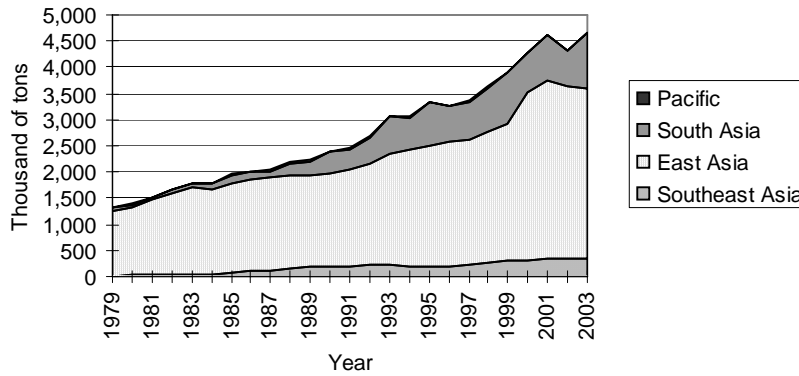

Source: FAOSTAT.

5.1.3 Beer from barley

Production of beer increased constantly during the period and reached around 38 million tons. in 2003 (Figure 5.4).

Figure 5.4 Production of beer from barley

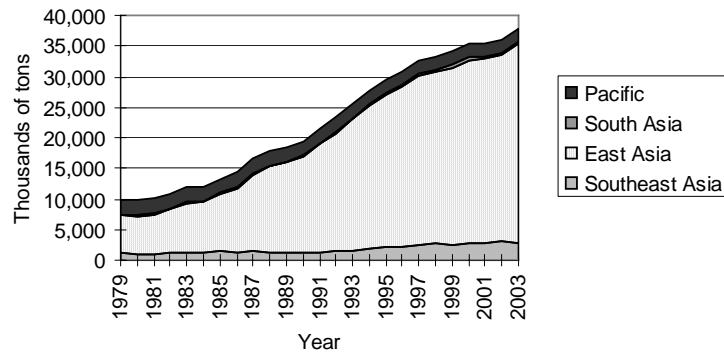

Source: FAOSTAT.

5.2 Industrial importance of secondary crops

As for 'modern' secondary crop processing, which uses innovative technology, biodegradable plastics and biofuel are the focus of this section.

5.2.1 Biodegradable plastics

General description

Biodegradable plastics can be used in the same way as conventional plastics but are decomposable to water and carbon dioxide through the action of naturally occurring microorganisms such as bacteria and fungi (Figure 5.5). They are classified into biopolymers, natural polymers and synthetic polymers. Biopolymers are directly produced by fermentation using starch hydrolysis products (glucose, etc.). Natural polymers are produced by the physical modification of natural products. Synthetic polymers are produced by the chemical modification of petroleum or natural materials. One of the major synthetic polymers is polylactic acid (PLA), which originates from crop starch. It not only reduces oil consumption but also prevents global warming because it originates from plants which absorb carbon dioxide in the atmosphere.

Figure 5.5 Life cycle of biodegradable plastics; the case of PLA

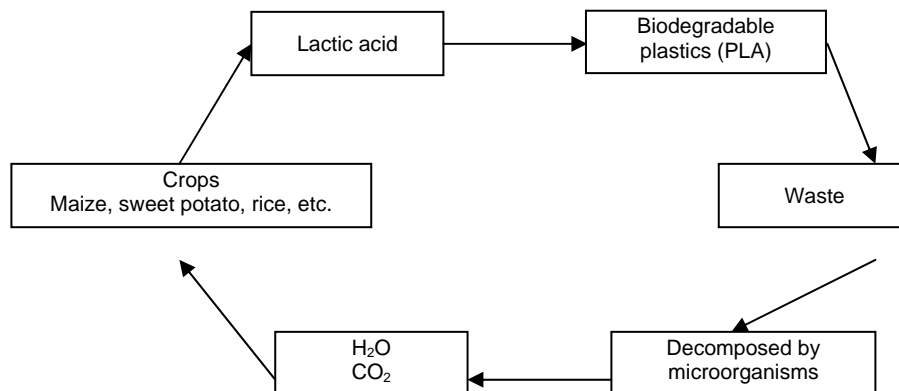

Source: Hanawa, 2002.

One of the obstacles hampering the exploitation of biodegradable plastics is their high price. However, mass production plans have begun. Since 2002, Cargill-Dow from USA has tried to improve price competitiveness and accelerate the diffusion of biodegradable plastics. Toyota, Japan's leading automobile producer and Sony, a well-known manufacturer of electric appliances in Japan, have already integrated biodegradable plastics into their products (Hanawa, 2002).

Biodegradable plastics can be produced from any crops that are price competitive and have high starch concentration. For instance, Cargill-Dow produces PLA from maize. Cassava starch is the cheapest carbon source in Thailand and can be applied to the

production of biodegradable plastics (Sriroth *et al.*, 2000). Toyota tried to use sweet potato for PLA production in Indonesia.

Production trends

Due to the high price compared to conventional plastics, the production of biodegradable plastics is relatively small. For example, the production of biodegradable plastics in Japan in 2001 was approximately only 6,000 tons. However, improvements in quality contribute to the expansion of biodegradable plastics. Major producers have already begun mass production projects, such as Cargill-Dow, which will expand annual production to 450,000 tons by 2010 (Hanawa, 2002).

Future prospects

Biodegradable plastics have the potential to substitute 30 per cent of total world plastic production, which is approximately 100 million tons (ARI, 1996). Given one-third of biodegradable plastics is synthetic polymer and half of synthetic polymer originates from plant material, the potential production of biodegradable plastics from secondary crops may be 5 million tons. Given the conversion rate of secondary crops to biodegradable plastics is 30 per cent, the potential demand for secondary crops might be 17 million tons, which is approximately equal to current maize production in South Asia.

Market expansion of biodegradable plastics raises the demand for secondary crops and reduces rural poverty through contract farming between biodegradable plastics producers and groups of small-scale farmers. Such contract farming and establishment of farmer groups will stabilize income and strengthen the bargaining power of small-scale farmers.

5.2.2 Renewable energy (biofuel)

General description

Renewable energy includes energy sources which are constantly replenished and will never run out, unlike fossil fuels (NREL, 2004). Renewable energy includes hydropower, solar energy, biomass, etc. Biomass is all the vegetation on earth such as plants, trees, algae and products that originate from them, excluding fossil resources like coal and petroleum. Biomass is principally an environmentally friendly resource and renewable as it comes from solar energy and is produced through photosynthesis.

Based on these characteristics, biofuel is one of the most promising ways to utilize biomass. Biofuels are liquid fuels for transportation made from various kinds of biomass.

The most common types of biofuels are ethanol made from carbohydrates and biodiesel made from vegetable oil.

Renewable energy has drawn attention many times since the first oil shock in the 1970s' but the boom always disappeared shortly after oil prices returned to normal. However, the current boom seems to have larger potential since it is based on factors unobserved before such as newly developed technology, global environmental issues as well as soaring oil price.

Since 2004, confronted by record high oil prices, several biofuel projects have emerged in Asia and the Pacific. People's Republic of China, which has seen surging oil consumption due to rapid economy growth, has begun selling gasoline mixed with 10 per cent ethanol in major cities. Alternative fuels, including biofuel, which have been used very little fuel consumption because of their higher price, have come under the spotlight in the era of historically high global oil prices (NIKKEI, 2004). Thai food groups plan to launch a US\$ 72 million biodiesel scheme, which includes a \$17 million palm oil refinery and a 3,200 hectare palm plantation, as the government promotes biofuel to lower its oil import bill (Reuters, 2004). To reduce air pollution due to emissions from public buses and trucks that run on diesel fuel, Jakarta city administration, capital city of Indonesia, plans to develop biodiesel fuel as an alternative to the fossil fuel burned in the diesel-fueled engines (Jakarta Post, 2004).

On the other hand, various mechanisms approved under the Kyoto Protocol will attract capital flow to developing countries for investment in renewable energy projects. The Clean Development Mechanism (CDM) is proposed as a part of the flexibility mechanisms of the Kyoto Protocol. CDM allows industrialized countries to fulfill their commitments to greenhouse gas emission reductions from reductions obtained in developing countries. Though developing countries have no obligation under the current protocol, if the industrialized countries assist their partners in developing countries to reduce gas emissions, it can be counted as an achievement by the industrialized countries. The mechanisms are expected to promote investment in renewable energy.

Food crops, which are rich in carbohydrate or oil, are used for raw material of biofuel. Sugarcane and other sugar or starch rich crops are fermented using yeast and other microorganisms and ethanol is produced. After a purification process, the crude ethanol is converted into fuel-grade ethanol. On the other hand, vegetable oil made from soybean, groundnut, maize and other oil crops is transformed into biodiesel through esterification. The amount of biodiesel produced by this process is equal to the amount of vegetable oil used,

which means the conversion rate is 100 per cent. Biodiesel can be used by most conventional cars without any engine upgrades. Secondary crops, which include a wide range of starch and oil crops, are an important source of biofuel.

The technology of biofuel was already established in the mid 1970's. Consumption has grown rapidly in the last several years (Figure 5.6).

Figure 5.6 Alcohol fuel consumption in USA

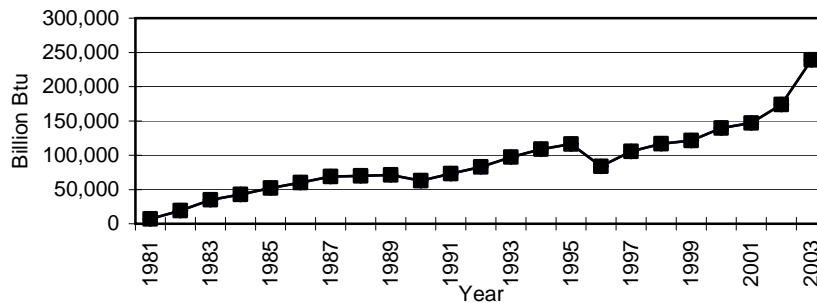

Source: Annual Energy Review 2003, Energy Information Administration (EIA), USA Department of Energy, <http://www.eia.doe.gov/emeu/aer/contents.html>.

Note: Value in 2003 is estimation. 1 Btu = 251.996 cal.

In some countries, supporting policies to expand the use of biofuel have been implemented. Since the 16th century, Brazil has always been an important sugar producer and exporter. Due to the prevailing trend of international sugar prices and increasing burden of the petroleum bill, in 1973, the Government of Brazil decided to launch the Ethanol Programme. After the second oil crisis, tax breaks made ethanol fuel at the pump and ethanol powered car prices highly attractive to consumers. In 2003, 3 million vehicles powered by hydrated alcohol consumed 4.9 billion litres. Over the last 22 years, hard currency savings amounted to US\$ 1.8 billion per year with the replacement of 200,000 barrels of gasoline per day. The industry has created 720,000 direct jobs and 200,000 indirect jobs in rural areas (Rovere, 2004).

Estimation of impact on secondary crops

We would like to estimate future consumption of biofuel in Asia and the Pacific based on current trends and conditions. We found several studies which forecast biofuel production using econometric models (Dipardo, 2002). The major objective of this section is to discuss the implications of biofuel production on policy formulation. Furthermore, due to a lack of statistical data in developing regions, we would like to estimate the growth of biofuel production in a very simple way by applying the growth trend of biofuel production in USA.

The scenario is that 0.1, 1.0 and 2.0 per cent of current gasoline consumption for public transportation is substituted by ethanol and 0.025, 0.05 and 0.1 per cent of current diesel consumption is replaced with biodiesel since the share of alcohol fuel in gasoline consumption and biodiesel in diesel in USA was about 2.1 per cent in 2003 and 0.09 per cent in 2004 respectively (Figure 5.7, 5.8).

Figure 5.7 Ratio of alcohol fuel to gasoline consumption in USA

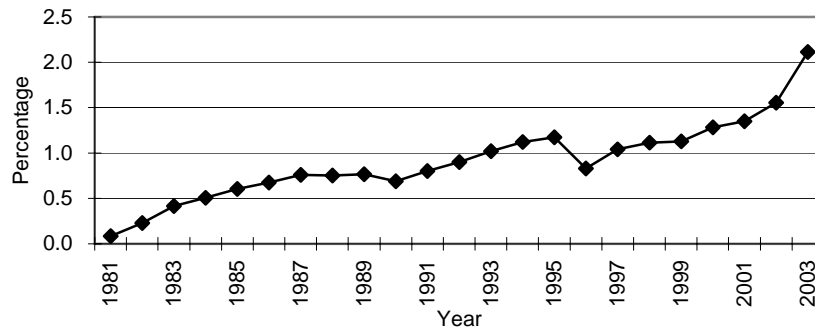

Source: Calculated by the author based on Annual Energy Review 2003, Energy Information Administration (EIA), USA Department of Energy, <http://www.eia.doe.gov/emeu/aer/contents.html>.

Note: Value in 2003 is estimation.

Figure 5.8 Ratio of biodiesel to conventional diesel consumption in USA

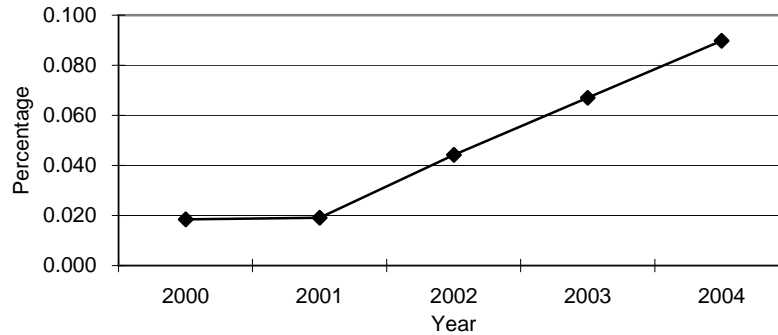

Source: Calculated by the author based on Alternative Fuels - Data, Charts, and Tables, Energy Information Administration (EIA), USA Department of Energy, http://eia.doe.gov/fuelalternate_njava.html.

Note: Value in 2004 is estimation.

The conversion rate of starchy crops alcohol is determined by their sugar content. Maize is the major raw material for alcohol fuel production and the conversion rate is 124.4 gallons per dry ton of feedstock (Table 5.1).

Table 5.1 Theoretical yield per dry ton of biomass feedstocks

Feedstock	Theoretical yield in gallons
Maize grain	124.4
Maize stover	113.0
Rice straw	109.9
Forest thinnings	81.5

Source: Theoretical Ethanol Yield Calculator, Energy Efficiency and Renewable Energy (EERE), USA Department of Energy (DOE), http://www.eere.energy.gov/biomass/ethanol_yield_calculator.html

The necessary amount of maize grain is computed as follows:

$$Y_1 = S_1 * X_1 / 124.4$$

Where;

Y₁: Maize grain (tons)

S₁: Share of alcohol fuel per gasoline consumption; 0.001 0.010, 0.020

X₁: Gasoline consumption in the area (gallons)

Since the theoretical conversion rate of vegetable oil into biodiesel is 100 per cent, the necessary amount of maize oil is equal to the expected consumption of biodiesel. Given the oil content of maize is 4.74 per cent (USDA, 2004) and gravity of maize oil is 0.92, the necessary amount of maize grain is computed as follows:

$$Y_2 = S_2 * X_2 / (1 - 0.0474) * 0.92$$

Where;

Y₂: Maize grain (tons)

S₂: Share of biodiesel per conventional diesel consumption; 0.00025, 0.0005, 0.001

X₂: Diesel consumption in the area (kilolitres)

The results show that Asia and the Pacific must boost maize production by 8,725 thousand tons or 4.8 per cent of current maize production, if 2 per cent of gasoline consumption is to be substituted by alcohol. Ethanol can be fermented not only from maize but other starchy crops. If ethanol is fermented from other starchy crops, the necessary increase in crop production will be different according to the starch content. If cassava and sweet potato are used as raw materials, the increase will be 17,023 thousand tons of cassava and 32,202 thousands tons of sweet potato, which represents an increase of 29.1 per cent and 28.2 per cent based on current production levels.

Maize production in India must expand by 49,000 tons or 0.4 per cent, if 0.1 per cent of conventional diesel consumption is substituted by biodiesel. If biodiesel is synthesized from other oil crops, the necessary increase in crop production will be 59,000 tons for soybean or 0.8 per cent of current soybean production (Table 5.2).

It is important that ethanol and biodiesel plants be constructed within regions with sufficient available starch and oil crops to perpetuate positive spill-over effects on the local economies and avoid negative effects on existing stakeholders as well as reducing transportation costs for raw materials. The simulation results, reveal 4.8 per cent increasing demand for maize if bioethanol demand in Asia and Pacific increased in line with USA. This may be difficult to realize if we consider maize production in Asia and the Pacific has grown by just 3.0 per cent annually in recent years (Figure 5.9).

Figure 5.9 Maize production in Asia and the Pacific

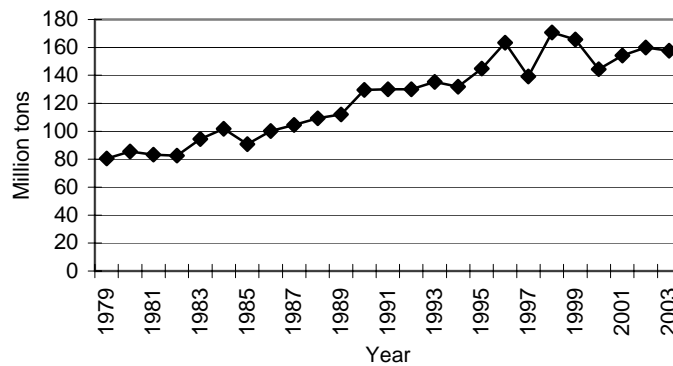

Source: FAOSTAT.
Annual growth rate: 3.5 per cent (1979-2003), 3.0 per cent (2000-2003).

Table 5.2 Necessary increase in crop production for biofuel production

Maize (Ethanol)						
Ratio of ethanol to gasoline consumption	Necessary increase (1 000 tons/year)			Production in 2004 (1 000 tons)	Necessary increase if 2% alternation (%)	Necessary area increase if 2% alternation (ha)
	0.10%	1.00%	2.00%			
P.R. China	108	1 084	2 169	131 860	1.6	420 813
India	21	209	419	14 000	3.0	203 508
Asia and the Pacific	436	4 362	8 725	183 327	4.8	2 141 925
Cassava (Ethanol)						
Ratio of ethanol to gasoline consumption	Necessary increase (1 000 tons/year)			Production in 2004 (1 000 tons)	Necessary increase if 2% alternation (%)	Necessary area increase if 2% alternation (ha)
	0.10%	1.00%	2.00%			
P.R. China	212	2 116	4 232	3 902	108.5	260 407
India	41	409	817	7 100	11.5	31 088
Asia and the Pacific	851	8 512	17 023	58 550	29.1	1 024 711
Sweet potato (Ethanol)						
Ratio of ethanol to gasoline consumption	Necessary increase (1,000 tons/year)			Production in 2004 (1,000 tons)	Necessary increase if 2% alternation (%)	Necessary area increase if 2% alternation (ha)
	0.10%	1.00%	2.00%			
P.R. China	400	4 003	8 005	106 197	7.5	400 194
India	77	773	1 546	900	171.8	171 825
Asia and the Pacific	1 610	16 101	32 202	114 053	28.2	1 756 390

Continued

Table 5.2 Necessary increase of crop production for biofuel production (continued)

Maize (Biodiesel)						
Ratio of biodiesel to conventional diesel consumption	Necessary increase (1 000 tons/year)			Production in 2004 (1 000 tons)	Necessary increase if 0.1% alternation (%)	Necessary area increase if 0.1% alternation (ha)
	0.025%	0.05%	0.10%			
India	12	25	49	14 000	0.4	23 933

Soybean (Biodiesel)						
Ratio of biodiesel to conventional diesel consumption	Necessary increase (1 000 tons/year)			Production in 2004 (1 000 tons)	Necessary increase if 0.1% alternation (%)	Necessary area increase if 0.1% alternation (ha)
	0.025%	0.05%	0.10%			
India	15	29	59	7 000	0.8	63 236

Source: Calculated by the author based on:

- 1) Gasoline Oil Trends 2003, Cambridge Energy Research Associates (Current gasoline consumption),
- 2) Biomass Information Headquarter, <http://www.biomass-hq.jp/foreign/index.html> (Current diesel consumption),
- 3) FAOSTATT (Crop production),
- 4) USDA National Nutrient Database, United States Department of Agriculture, <http://www.nal.usda.gov/fnic/foodcomp/search/index.html> (Starch and oil content in crops).

Note: Current annual gasoline consumption: 321 million barrels (People's Republic of China), 62 million barrels (India), 1,292 million barrel (Asia and the Pacific) (2002). Current annual diesel consumption: 47 million kilolitres (India) (2002).

It is generally accepted that there are two ways of expanding crop production. One is to increase yield and the other is to expand area. To meet the higher demand through area expansion alone, the maize cropping area would need to be expanded by around 2.1 million hectares. If cassava is used as feedstock for ethanol production, the area increase is 1.0 million hectares, less than half of maize, thanks to its high starch content. Therefore, selection of raw materials for biofuel is very important to save land resources if the additional demand is to be covered by expansion of cropping area. However, this option is not very practical since land is already a limited resource in most parts of the region. Conversion from major cereals to starchy secondary crops should be considered based on the sustainability of agricultural production in disadvantaged areas.

Another option is to raise maize yield by adopting high-yielding varieties and improved cropping practices. The average yield of maize in most Asian countries is below the level of developed regions. Many studies have shown that the actual yield level in farmers' fields is less than the potential yields observed in experimental fields. Yield potential is defined as the yield of a crop cultivar when grown in environments to which it is adapted, with nutrients and unlimited water, and pests and diseases are effectively controlled (Evans, 1993). The yield gap between what is possible and what is actually achieved is often quite large, especially in the more marginal environments. In the less-favourable production environments, the yield gap is substantially wider. This option is more practical than expanding harvested area.

It is reported that building and operating a biofuel plant has positive economic impacts on a local community. A study in USA found that 40-million-gallons-per-year ethanol plant would create 41 full-time jobs at the plant and a total of 694 jobs throughout the entire economy, raise the local price of maize by an average 5-10 cents a bushel, adding significantly to farm income in the general area surrounding the plant (Urbanchuk, 2002).

The major determinant of S1 and S2 (How far conventional fuel is substituted by biofuel?) will be gasoline and conventional diesel prices. The relationship between alcohol fuel consumption and gasoline prices is shown in Figure 5.10. The figure shows a positive relation between gasoline price and alcohol fuel consumption ($R^2 = 0.84$). It is also known that a sharp drop in global oil prices in the mid-eighties seriously affected the cost-effectiveness of alcohol fuel in Brazil (Rovere, 2004). We conclude that future demand for biofuel will be strongly affected by conventional fuel prices.

Figure 5.10 Correlation between gasoline price and alcohol fuel consumption

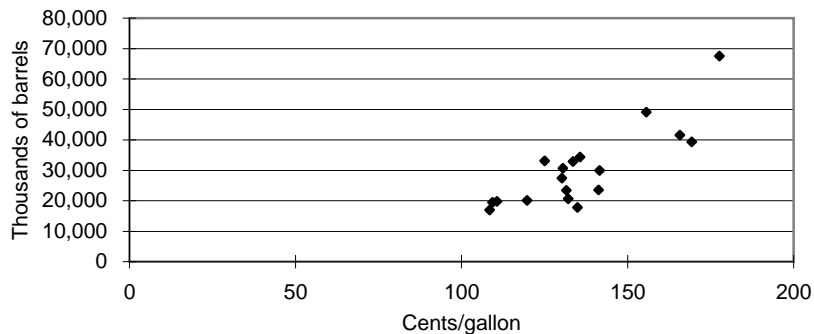

Source: Formulated by the author based on Annual Energy Review 2003, Energy Information Administration (EIA), USA Department of Energy, <http://www.eia.doe.gov/emeu/aer/contents.html>

Policy options to exploit the opportunities

Expanding the use of secondary crops for renewable energy will significantly increase demand for the crops by 8.7 million tons of maize equivalent per year in Asia and the Pacific if bioethanol consumption grows in line with USA. The growth in demand will provide good opportunities to secondary crop farmers to raise the productivity of their farming activities. To alleviate poverty by exploiting this opportunity, policy support should be carefully designed because previous crop booms have not necessarily succeeded in improving the welfare of the rural poor. In the absence of proper policy measures, such an increase can, in turn, create negative impacts on rural welfare like unstable commodity prices, environmental degradation and further exploitation of the poor farmers.

In the conclusion of this chapter, we would like to propose basic policy options to better exploit the potential.

Dissemination of high-yielding varieties (HYV)

As discussed, it is difficult to meet increases in demand for secondary crops through area expansion alone. AGRIDIV country studies have shown that some improved varieties of secondary crops have been already developed in research institutes in the region. However, due to poor dissemination and marketing activities, the number of farmers who adopt improved varieties is still low. The constraints faced by farmers in using improved varieties include a lack of resources in the extension system, an undeveloped seed distribution system and lack of funds to purchase improved seeds and fertilizers, which are indispensable to achieve the potential yield of HYV. Measures to mitigate the constraints are required.

Tax and subsidies

Even though biofuel has positive impacts on the environment and saves foreign currency from petroleum imports, the largest impediment to expand biofuel consumption is its higher price than conventional fuel. Tax and subsidy schemes would be very useful to change consumer preference to biofuel. In Germany, biodiesel is subsidized so its price is lower than conventional diesel fuel. This scheme is a major factor in the popularity of biodiesel use in Germany. Ethanol production in USA grew from 175 million gallons in 1980 to 1.4 billion gallons in 1998, with support from Federal and State ethanol tax subsidies and mandatory use of high-oxygen gasoline. However, the Federal ethanol subsidy, which brings the cost of ethanol close to the wholesale price of gasoline is due to expire in 2007. It is forecast that gasohol and FRG (Federal Reformulated Gasoline) blended with ethanol will cease if the subsidy is eliminated in 2008 (Dipardo, 2002).

Subsidies for biofuel are a controversial issue. In USA, the 1978 Energy Tax Act allowed for a 4-cents-per-gallon exemption for ethanol fuel from federal fuel excise taxes and the rate was raised to 6 cents per gallon during the 1980s but reduced to 5.4 cents in 1990. Since 1978, the federal treasury lost on average \$770 million in revenue every year from the partial tax exemptions alone (St. Louis Post, 2001). It is unlikely that most developing countries can bear the huge cost of cutting the biofuel price. The scenario of substituting 2 per cent of gasoline with biofuel is ambitious and the 0.1 per cent scenario is more realistic since it is the same as the biodiesel consumption ratio to conventional diesel in USA, which is not heavily subsidized unlike ethanol.

Foreign investment

Various mechanisms approved under the Kyoto Protocol will attract capital flow to developing countries for investment in renewable energy projects. The Clean Development Mechanism (CDM) as well as Joint Implementation (JI) is proposed as a part of the 'flexibility mechanisms' of the Kyoto Protocol. CDM allows industrialized countries to fulfill their commitments to greenhouse gas emission reductions from the reduction in developing countries. Though developing countries have no obligation under the current protocol, if the industrialized countries assist their partners in developing countries to reduce gas emissions, it can be counted as an achievement by the industrialized countries. JI is a similar mechanism but between industrialized countries. Both mechanisms are expected to promote investment in renewable energy. If large-scale tax reductions in biofuel seem unrealistic due to the financial burden, the promotion of investment from developed countries using CDM schemes is a more practical option to promote biofuel production.

Overall agricultural development plan

Currently, the major material for ethanol production is starchy crops like maize. Although cellulosic materials like crop residues, municipal solid waste, yard trimmings, grasses and trees are less expensive than starch crops, they are more costly to convert into ethanol because of the extensive processing required to convert cellulose into sugar. However, technology innovation will substitute starchy crops by cellulose-based material in the near future. We need to consider overall agricultural development while promoting secondary crop production for biofuels in case the crops lose advantage as raw materials for fuel. Additional value-adding activities for secondary crops will be necessary while providing crop residues like corn stover for fuel production. Furthermore, environmental issues should be considered because if crop residues are removed from fields as raw materials for fuel production, the organic material in the soil must be compensated to prevent soil fertility loss.

5.3 Concluding summary

Though direct consumption of secondary crops as food has decreased continuously for two decades, the production of secondary crops is still expanding due to their rise in use as raw materials for industry. As for traditional type processing, the production of maize oil, soybean oil and beer from barley has increased continuously. As for modern type processing, biodegradable plastics have the potential to substitute 30 per cent of total global plastic production. Asia and the Pacific need to boost maize production by 4.8 per cent of current production, if 2 per cent of gasoline consumption is substituted by alcohol, which is equivalent to the current ratio of ethanol use in USA. The growth of secondary crop demand induced by modern processing will provide good opportunities for secondary crop farmers to raise productivity and income. To alleviate poverty by exploiting this opportunity, policy support should be carefully designed because previous crop booms have not necessarily succeeded in improving the welfare of the rural poor.

Reference

- ARI (Applied Research Institute), 1996. Seibunkaisei Plastics (Biodegradable Plastics), www.ari.co.jp/sentan/seibunkai.html.
- Bourgeois, Robin and Balerin, Yanick (eds.), 2003. Domestic Supply and Consumption Patterns of Coarse Grains, Pulses, Roots and Tuber Crops in Asia and the Pacific. CGPRT Monograph No. 45, Bogor, Indonesia: CGPRT Centre.

- Dipardo, Joseph, 2002, Outlook for Biomass Ethanol Production and Demand, <http://www.eia.doe.gov/oiaf/analysispaper/biomass.html>.
- Evans, L.T., 1993. Crop Evolution, Adaptation, and Yield. Cambridge, UK: Cambridge University Press.
- FAE (Foundation of Alternative Energy): www.seps.sk/zp/fond/direct/biomass.html
- Hanawa, K., 2002. Kakudai ga kitaisareru seibunkaisei plastic sijo (Expectancy for expansion of biodegradable plastics markets), Economic notes, December 2002, Development Bank of Japan.
- Jakarta Post, 2004. Biodiesel Fuel Could Free Jakarta from Pollution (9 January 2004).
- La Rovere, Emilio Lèbre, 2004. The Brazilian Ethanol Program - Biofuels for Transport, International Conference of Renewable Energy, 1-4 June 2004, Bonn.
- National Renewable Energy Laboratory, the US Department of Energy (NREL), <http://www.nrel.gov/> (17 September 2004).
- NIKKEI, 2004, Sekyu Ihen (Oil emergency), 6 September 2004.
- Reuters, 2004. Thailand Plans \$72m Biofuel Schemes, Jakarta Post (1 September 2004).
- Sriroth K., Chollakup R., Piyachomkwan K., Oates C.G., 2000. Biodegradable Plastics from Cassava Starch in Thailand, Cassava's Potential in Asia in the Twenty-first Century. Present Situation and Future Research and Development Needs. Proceeding of the sixth regional workshop held in Ho Chi Minh City, Vietnam, February 21-25, 2000.
- St. Louis Post, 2001. Midwestern Farmers Push for Biodiesel Subsidies (29 August 2001).
- Urbanchuk, John, 2002. Ethanol and the Local Community, AUS Consultants and Jeff Kapell, SJH & Company, June 2002, http://www.ethanilrfa.org/Ethanol_Local_Community.PDF.
- USDA, 2004. USDA National Nutrient Database for Standard Reference, <http://www.nal.usda.gov/fnic/foodcomp/search/index.html>.

6. Prioritization of Research and Development for Sustainable and Diversified Agriculture

*Tomohide Sugino**

6.1 Introduction

The purpose of this chapter is to examine the priority of research and development to realize diversified agriculture in selected Asian countries. Agricultural diversification means to transform agriculture from rice/wheat dominated cropping systems into more diversified systems, especially promoting secondary crop production, or to integrate agricultural production with marketing or processing. Agricultural diversification has various impacts including raising income, mitigating risks and enhancing the sustainability of agriculture.

Among the avenues to achieve the goal of diversified agriculture, technology development is one of the most important measurements. The Phase I country studies of the AGRIDIV project identified 80 constraints to agricultural diversification; more than half were technical issues (Table 6.1). However, most of the governments in Asian developing countries face financial difficulties and it is not easy for them to meet all the developmental needs with the limited financial and human resources. Therefore, prioritization of research and development (R&D) topics is important to conduct technology development effectively. To support policy planners to allocate resources in an appropriate manner, a questionnaire survey was conducted in eight Asian countries (Bangladesh, India, Indonesia, Lao People's Democratic Republic, Sri Lanka, Thailand and Viet Nam), participating in the AGRIDIV project.

* JIRCAS, Japan.

Table 6.1 Constraints to agricultural diversification

Field	Number of factors
Technological development	43
Marketing	9
Access to credit	7
Processing	5
Price & trade policy	3
Infrastructure	2
Input	1
Organizational structure	1
Land policy	1
Others	8
Total	80

Source: Compiled by author based on Alam, J., 2005a, Anh, D.T., 2005, Douangsavanh, L. *et al.*, 2006, Kyi, A., 2005, Mahrouf, A.R.M., 2005, Roonnapai, N., 2006, Singh, R.P. *et al.*, 2005a, Siregar, M., 2006

6.2 Methodology

6.2.1 Structure of the questionnaire

The questionnaire was designed referring to the survey sheet used for the Technology Forecast Survey, which is conducted by the Ministry of Education, Culture, Sports, Science and Technology (MEXT), Government of Japan (NISTEP, 2001). The survey consists of two parts, namely Step 1 and Step 2. Step 1 includes questions about the profile of respondents. Step 2 is designed to investigate the importance, expected effects and necessary support of 15 R&D topics concerning agricultural diversification (Table 6.2).

The 15 R&D topics were collected from the study results of the AGRIDIV country studies. In the AGRIDIV project, the national experts from the participating countries identified constraints to agricultural diversification in their respective countries based on the results of secondary data analysis and rural surveys. Out of 80 factors identified in eight countries, 43 factors were technologically oriented. Among these factors, 15 topics were selected for this survey that constitute common problems in the region and are significant to poverty alleviation in rural areas (Table 6.3).

Table 6.2 Items included in the questionnaire

Step 1	
1. Name of respondent	
2. Sex	
3. Year of birth	
4. Profession (Choose from Research, Research management, Policy planning, Extension, Farming, Education and Others)	
5. Organization (Choose from Research institute, Administrative agency, Extension organization, Farm, Farmers' organization, University, Private company and Others)	
Step 2	
A) The degree of the respondent's expertise in the respective research topics (Choose from the options below)	
High:	You have considerable knowledge as a specialist about the topic through current research or work related to the topic.
Medium:	You were once engaged in research or work related to the topic; or have some specialist knowledge about the topic through research or work in a similar field.
Low:	You have read technical books or literature about the topic or have listened to experts connected with the topic.
None:	You have no expertise in the topic.
B) Degree of importance to your country (Choose from the options below)	
High:	Extremely important
Medium:	Important
Low:	Somewhat important
Unnecessary:	Not important
Unknown:	You have no expertise in the topic
C) Expected effect (Choose from the options below)	
Poverty alleviation:	Contribution to poverty alleviation especially in rural areas. Increase or stabilize income and create job opportunities, contribution to rural welfare, etc.
Socio-economic development:	Contribution to creation of new industry and urban employment, development of social and economic infrastructure, etc.
Environmental issues:	Resolution of regional or global environmental problems, protection of the natural environment and ecology, prevention of environmental destruction and pollution, optimal use of natural resources, etc.
Intellectual resources:	Expansion of human intellectual resources through discovery of new rules and principles, establishment of original theories, development of art and culture, etc.
D) Effective measurement should be taken to implement the research topic and realize expected effect (Choose from the options below)	
Human resources development:	Foster human resources through education, training and securing an appropriate number of researchers, technical personnel and research supporters.
Infrastructure:	Develop research and development infrastructure such as equipment, establishment of databases, provision of reference materials and gene resources.
Funding:	More research funds injected by the government, international funding organizations, developed countries and private investment.
Integration with extension:	Reinforce integration of research and extension through capacity development of extension systems and closer collaboration between research and extension staff to promote technology transfer to farmers and other users.
Domestic research collaboration:	Research collaboration among organizations in your country.
International research collaboration:	Research collaboration with other countries in the region, developed countries or international research institutes.
Collaboration among sectors:	Promotion of collaboration among the academic sector (research institutes, universities, etc.), and the government and private sectors (private companies, NGOs, farmers groups, etc.)

Source: Questionnaire survey, 2005.

Table 6.3 R&D topics surveyed

Research topics	Short title
1. Development of technology to improve soil fertility in an economical way (e.g. growing green manure crops, application of compost)	Economical soil improvement
2. Development of effective use of inputs to minimize the cost and maximize the output (e.g. micro-doses of fertilizers: application of small quantities of fertilizers directly into the planting hole to minimize input costs)	Effective input use
3. Development of technologies to prevent soil erosion in upland areas	Soil conservation
4. Development of improved crop varieties with stable yield under abiotic stress like water deficiency or high temperatures (e.g. early maturing varieties to escape post-flowering moisture stress periods)	Stress tolerant variety
5. Development of improved intercropping technology which minimizes labour inputs and maximizes overall products in the farmland (e.g. appropriate seeding rate choices for a two-crop intercropping)	Intercropping technology
6. Development of cheaper agricultural machinery available to farmers	Cheaper machinery
7. Development of labour saving technologies for crop cultivation	Labour saving technology
8. Development of improved crop varieties with high disease and pest tolerance or high competitiveness with weeds	Pest tolerant variety
9. Development of pest and weed control technology in economical ways (e.g. crop rotation with pest non-susceptible varieties, increased density of crops to close the canopy more rapidly, damage control from wild animals)	Economical pest control technology
10. Development of appropriate water management technologies, which enable upland crop cultivation in lowland areas or paddy fields	Water management technology
11. Development of improved processing technology to increase the demand of crops as processed food or feed	Food/feed processing technology
12. Development of technology for non-food/feed processing and establishment of new uses (e.g. biodegradable plastics and biofuel from maize, cassava, etc)	Non-food/feed processing technology
13. Development of technology to decrease contamination of poisonous materials in crops to meet sanitary standards for export (e.g. cadmium, arsenic and sulfur dioxide content in cassava products)	Decreasing contamination
14. Implementation of consumers' preferences surveys to be aware of changing demand for food	Consumer preference survey
15. Clarification of profitability, production costs, marketing, environmental limitations, acceptance of new technologies and other socio-economic conditions of farmers	Socio-economic survey

Source: Questionnaire survey, 2005.

The questionnaires were distributed to the national experts of AGRIDIV in February 2005. The national experts were requested to select respondents to survey from the field of agricultural technology development. All the answer sheets were collected by the national experts and returned to CAPSA by July 2005.

6.3 Results

6.3.1 Profiles of respondents

The number of respondents from the eight countries totalled 259. Forty-one per cent of the respondents are researchers followed by extension staff. Forty-four per cent of the respondents belong to research institutes followed by universities (Table 6.4 and 6.5).

Table 6.4 Profession of respondents

Profession	Persons	Percentage
Research	107	41
Extension	36	14
Education	29	11
Policy planning	27	10
Farming	27	10
Research management	18	7
Others	15	6
Total	259	100

Source: Questionnaire survey, 2005.

Table 6.5 Place of work of the respondents

Organization	Persons	Percentage
Research institute	115	44
University	38	15
Extension services	36	14
Administration	24	9
Farm	24	9
Private company	5	2
Farmers' organization	2	1
Others	15	6
Total	259	100

Source: Questionnaire survey, 2005.

6.3.2 Priority of R&D topics

The respondents were requested to evaluate the priority of the R&D topics by selecting their answer from four options, namely 'High' (extremely important), 'Medium' (important), 'Low' (somewhat important) and 'Unnecessary' (not important). The respondents who answered they have no expertise in the topic were excluded from further analysis. The degree of importance of the topics was estimated by calculating the 'Importance Index (I-Index)'. I-Index is an indicator showing the importance of R&D topics (NISTEP, 2001).

$$\text{Importance Index (I-Index)} = \frac{[(\text{The number of respondents who answered 'High'}) * 100 + (\text{The number of respondents who answered 'Medium'}) * 50 + (\text{The number of respondents who answered 'Low'}) * 25 + (\text{The number of respondents who answered 'Unnecessary'}) * 0]}{\text{Total number of respondents}}$$

[Total number of respondents (excluding respondents who answered they have no expertise in the topic)]

If all the respondents answered 'High' for a specific R&D topic, the I-Index would be 100, while if all the respondents answered 'Unnecessary', the I-Index would be zero.

Table 6.6 shows the I-Index of all the surveyed R&D topics computed from the answers of all the respondents in the eight countries. 'Pest tolerant variety' received the highest I-Index as well as 'Economic soil improvement'. The I-Index of the other four R&D topics, namely, 'Effective input use', 'Soil conservation', 'Stress tolerant variety' and 'Food/feed processing technology' received almost the same level, which were equal to or more than 80. On the other hand, 'Labour saving technologies' had the lowest PI, followed by 'Consumer preference survey' and 'Intercropping technology'.

Comparing the I-Index among the respective eight countries, 'Labour saving technologies' has the largest standard deviation (SD=11.5), followed by 'Water management technologies' (SD=11.3). As for the former, Sri Lanka received the highest I-Index, while the I-Index of the other seven countries was below 70. As for the latter, the I-Index of Sri Lanka was also the highest and is the only country whose I-Index is greater than 90.

6.2.3 Expected effects of the R&D topics

The results of the survey on the expected effects of R&D topics are shown in Table 6.7. Among all the respondents in the eight countries, 80 per cent or more agreed that 'Poverty alleviation' would be achieved through the technological development of 'Intercropping technology and 'Pest tolerant varieties' (indicated as 'A' in Table 6.7). As for the effect of 'Socio-economic development', 80 per cent or more of respondents answered 'Cheaper machinery', 'Labour saving technology', 'Pest tolerant varieties', 'Food/feed processing technology', 'Consumer preference survey' and 'Socio-economic survey' would have positive impacts (indicated as 'A' in Table 6.7). 'Economical soil improvement', 'Soil conservation', 'Pest tolerant varieties', 'Economical pest control' and 'Decreasing contamination' are the topics which 80 per cent or more respondents thought would contribute to 'Environmental issues' (indicated as 'A' in Table 6.7). There were no R&D topics surveyed for which more than 50 per cent of respondents thought the topics would be effective to increase 'intellectual resources'.

Table 6.6 Importance Index (I-Index) of the 15 R&D topics

R&D topic	Bangladesh	India	Indonesia	Lao PDR	Myanmar	Sri Lanka	Thailand	Viet Nam	Total	SD
1. Economical soil improvement	95	71	96	83	87	95	79	86	88	8.7
2. Effective input use	86	75	85	62	93	93	81	77	80	10.3
3. Soil conservation	66	79	82	70	86	95	80	89	80	9.6
4. Stress tolerant variety	85	81	81	69	87	90	68	88	81	8.7
5. Intercropping technology	70	68	72	65	88	76	64	62	69	8.3
6. Cheaper machinery	86	84	82	62	83	92	72	71	78	10.0
7. Labour saving technology	52	67	61	67	61	89	68	53	63	11.5
8. Pest tolerant varieties	89	80	92	74	85	100	84	95	88	8.4
9. Economic pest control technology	79	79	73	63	82	98	78	80	78	9.7
10. Water management technology	73	84	70	60	63	93	83	74	74	11.3
11. Food/feed processing technology	83	90	87	69	88	88	81	76	82	7.2
12. Non-food/feed processing technology	73	75	61	57	58	82	83	66	70	10.1
13. Decreasing contamination	79	71	68	61	65	85	80	85	75	9.3
14. Consumer preference survey	74	75	73	58	50	68	71	55	67	9.8
15. Socio-economic survey	79	83	81	67	77	92	76	76	78	7.2

Source: Questionnaire survey, 2005.

Table 6.7 Expected effects and measures to achieve them

	1.Economical soil improvement	2.Effective input use	3.Soil conservation	4.Stress tolerant variety	5.Intercropping technology	6.Cheaper machinery	7.Labour saving technology	8.Pest tolerant varieties
Importance index	88	80	80	81	69	78	63	88
Expected effect								
Poverty alleviation	B	B	C	B	A	B	C	A
Socio-economic development	C	B	C	B	B	A	A	A
Environmental issues	A	C	A	D	D	D	D	A
Intellectual resources	D	D	D	D	D	D	D	D
Measurement								
Human resources development	B	B	B	B	C	B	B	B
Infrastructure	D	D	D	D	D	D	D	D
Funding	B	C	B	B	C	B	C	A
Integration with extension	B	B	B	C	B	C	C	B
Domestic research collaboration	B	C	C	C	C	C	C	A
International research collaboration	C	D	D	B	D	D	D	A
Collaboration among sectors	C	D	C	D	D	D	D	B

Source: Questionnaire survey, 2005.

Note: As for expected effects and measurements, each grade represents the following:

A: Quite effective (100-80 per cent of respondents chose the option).

B: Effective (65-79 per cent).

C: Somehow effective (50-64 per cent).

D: Less effective (0-49 per cent).

Continued

Table 6.7 Expected effects and measures to achieve them (continued)

	9.Economical pest control technology	10.Water management technology	11.Food/feed processing technology	12.Non-food/feed processing technology	13.Decreasing contamination	14.Consumer preference survey	15.Socio-economic survey
Importance index	78	74	82	70	75	67	78
Expected effect							
Poverty alleviation	C	C	B	C	D	D	B
Socio-economic development	B	B	A	B	B	A	A
Environmental issues	A	B	D	B	A	D	D
Intellectual resources	D	D	D	D	D	D	D
Measurement							
Human resources development	B	B	B	B	B	B	B
Infrastructure	D	D	D	D	D	D	D
Funding	B	B	B	B	B	C	B
Integration with extension	A	C	C	C	C	C	B
Domestic research collaboration	A	B	C	B	C	C	C
International research collaboration	A	D	C	C	B	D	D
Collaboration among sectors	C	C	C	C	D	D	C

Source: Questionnaire survey, 2005.

Note: As for expected effects and measurements, each grade represents the following:

A: Quite effective (100-80 per cent of respondents chose the option).

B: Effective (65-79 per cent).

C: Somehow effective (50-64 per cent).

D: Less effective (0-49 per cent).

Seeing the results of the respective countries, the number of countries for which 80 per cent or more of the respondents suggested that specific technologies would contribute to poverty alleviation are shown in Figure 6.5. Eighty per cent or more of respondents replied that 'Intercropping technology' would contribute to poverty alleviation in six countries. Oppositely, no country achieved 80 per cent for 'Soil conservation', 'Labour saving technology', 'Decreasing contamination' and 'Consumers' preferences' survey.

Figure 6.1 Number of countries where 80 per cent or more of the respondents expected poverty to be alleviated by the R&D topics offered

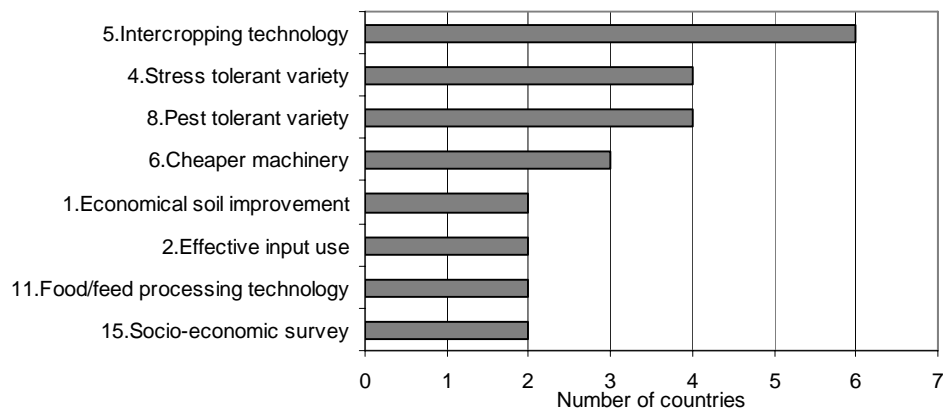

Source: Questionnaire survey, 2005.

6.3.4 Effective measures to implement the research topics

The effective measures found in the survey that should be taken to implement research topics and realize the expected outcomes are shown in Table 6.7. While almost all other options received relatively higher support from the respondents, less than 50 per cent replied that infrastructure development would be a useful measure to achieve the expected effects of technological development.

6.4 Discussion

One important feature of agriculture in developing Asian countries is low labour productivity and excess labour in rural areas due to a lack of labour absorption in the industrial sector (Yamada, 1992). The results of evaluating the priority of R&D topics show that these characteristics are well recognized by the respondents. Cost saving technologies, such as technologies to improve soil fertility with local resources (green manure crops, compost, etc.) and the development of varieties with high pest tolerance, which can reduce

chemical fertilizer and pesticide consumption are recognized as the most important technologies out of 15 R&D topics. Meanwhile, 'Labour saving technology' received low priority, which will contribute to cost reduction but may result in negative impacts on employment unless alternative job opportunities are provided.

However, if we see the results of respective countries, we find that some countries have different tendencies for R&D priority. Unlike the other seven countries, Sri Lanka gave high priority to 'Labour saving technology'. This seems to be attributable to the fact that labour saving is a key issue in Sri Lanka. The per capita gross national income of Sri Lanka is the second highest of the surveyed countries (World Bank, 2005). As a consequence, the agricultural wage rate is supposed to be higher than the other countries. In addition, the reconstruction project of the tsunami disaster in 2004 accelerated the demand for labour in the country (Personal communication to the National Expert of AGRIDIV project in Sri Lanka). Against this backdrop, labour saving technologies are exceptionally more important in Sri Lanka.

In this paper, we would like to select the six priority R&D topics with I-index of 80 or more for further analysis. By analyzing the results of the survey on the three expected effects, namely, 'Poverty alleviation', 'Socio-economic development' and 'Environmental issues', we can reveal why the six R&D topics received higher priority (I-Index = 80 or more) in the surveyed region.

Among the options of expected effects, 'Poverty alleviation' can be recognized as a proxy of direct or short-term impacts on the welfare of rural poor people. 'Socio-economic development' can be recognized as a proxy of long-term impacts on welfare. 'Environmental issues' can be used as a proxy of external economic impacts. In this discussion, we would like to determine whether a specific R&D topic is quite effective in achieving a specific effect, if the R&D topic was supported by 80 per cent or more respondents for the effect (indicated as 'A' in Table 6.7), effective if supported by 65 to 79 per cent of respondents (indicated as 'B' in Table 6.7), and somehow effective if supported by 50 to 64 per cent (indicated as 'C' in Table 6.7).

All the R&D topics can be classified based on the expected effect (Figure 6.2). Among the six priority topics, 'Pest tolerant varieties' was the only topic recognized as quite effective for all three effects. We can conclude that this kind of technology is a 'Mighty technology' which can have multiple impacts.

Figure 6.2 Classification of the surveyed R&D topics

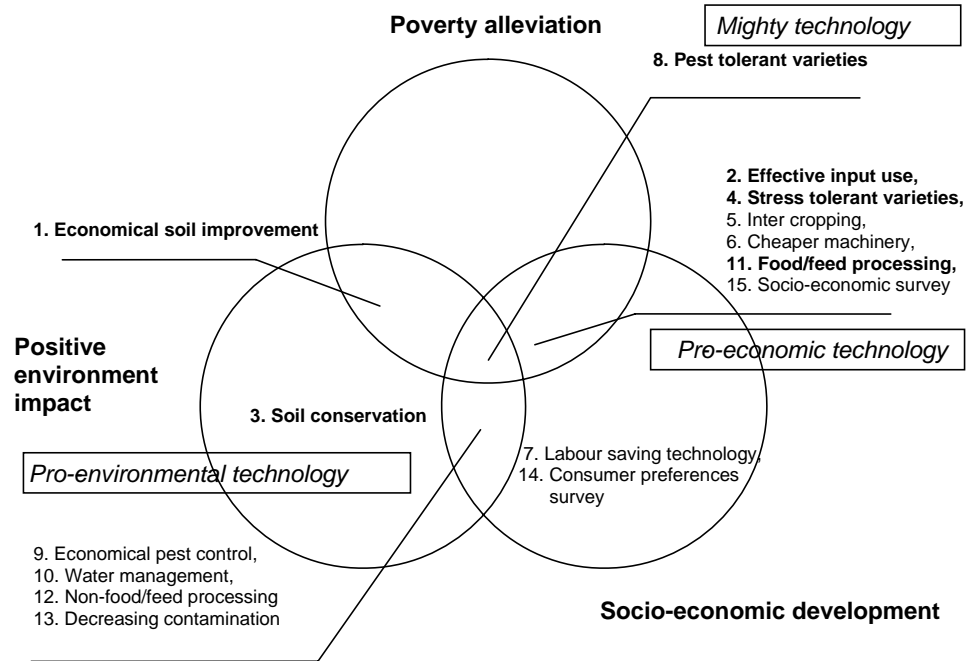

Source: by author.

Note: Six Priority R&D topics are shown in bold. The classification was conducted by seeing whether each R&D topic received grade A or B (supported by 65-100 per cent of respondents).

The second group of priority R&D topics consists of 'Economical soil improvement' and 'Soil conservation'. They were recognized as quite effective in terms of 'Environmental issues', while 'Poverty alleviation' and 'Socio-economic development' scored relatively lower. This indicates that respondents recognized these technologies have more economic externalities than short/long-term economic impacts. If the budget of a government is limited but it is urgent to tackle poverty alleviation, such R&D topics would be considered less urgent. Therefore, external support is required for this second group of technologies, namely 'Pro-environmental technologies', to mitigate the negative impacts of agricultural development.

The third group of priority R&D topics consists of 'Pro-economic technologies' which are recognized as effective to improve rural welfare both on a short and long-term basis with less expected economic externalities. The group includes 'Effective input use', 'Stress tolerant varieties' and 'Food/feed processing technology'. They are thought to be quite effective or effective for short/long-term welfare improvement but relatively less effective for economic externalities.

It is interesting to note that 'Effective input use' is included in this group, which means that respondents expected the reduction of fertilizer consumption would have less positive effects on environmental problems. A possible interpretation is that the respondents are afraid of the negative impacts of reduced input use, especially reducing fertilizer inputs would result in the deterioration of soil fertility. 'Stress tolerant varieties' is an effective measure to expand crop production in disadvantaged areas. However, the results of the survey show the respondents are afraid of the negative impacts of the technology, since the environment in disadvantaged areas is very fragile and the expansion of crop production in such areas could trigger negative impacts unless properly managed. 'Food/feed processing' or value adding activities are known as effective measures to augment rural income and generate employment. The survey results indicate that in spite of the positive impacts of value adding, it can occasionally cause serious negative impacts on the environment such as water pollution and odor, which are serious problems in developing regions where environmental regulations are not well implemented.

The I-Index of 'Labour saving technology' was low in most countries while it was thought to be quite effective for socio-economic development based on the survey results (Table 6.7). This indicates that the respondents clearly recognized its long-term impact. Most Asian developing countries have excess labour in rural areas. However, if non-agricultural industry is developed in the near future, the availability of rural labour drops relatively. The survey results reflect the respondents' perspectives of rural development in the future. A similar tendency can also be found for 'Non-food/feed processing technology', 'Decreasing contamination' and 'Consumer preference survey', for which it can be interpreted that these R&D topics are expected to be important after preliminary economic development has been achieved.

6.5 Concluding summary

There are various technology development needs in developing regions. If we consider the limited resources which can be allocated to R&D activities, prioritization of technology development should play an important role in the policy planning process. This survey has given an example of the prioritization process and interpretation of survey results. It should be noted that the results of the survey can indicate only a rough direction for technology development. Therefore, it is necessary to conduct further analysis using a participatory approach to identify the specific research topics which meet the practical needs of the end users. It is hoped that the results of the present survey will provide a good

opportunity for all stakeholders to consider the R&D strategies which can contribute to the overarching goals of technology development, namely as poverty alleviation and environmental conservation.

References

- NISTEP (National Institute of Science and Technology Policy), 2001. The Seventh Technology Foresight: Future Technology in Japan toward the Year 2030.
- World Bank, 2005. The World Development Indicators 2005, available on line at <http://www.worldbank.org/data/wdi2005>.
- Yamada, S., 1992. Asia nogyo hatten no hikaku kenkyu (A comparative study on Agricultural development in Asia) (Tokyo, University of Tokyo press), (in Japanese).

7. Utilizing Secondary Crops for Development and Poverty Alleviation under Globalization

Hitoshi Yonekura^{*}

This chapter aims to examine the strategy of utilizing secondary crops for poverty alleviation in Asian countries based on the results of the AGRIDIV project. The project covered countries: of Bangladesh, India, Indonesia, Myanmar, Sri Lanka, Thailand, Lao People's Democratic Republic and Viet Nam; where maize, soybean, potato, cassava and some kinds of pulses are significant secondary crops and widely produced. This paper will overview secondary crop uses in the study countries under the large impact of diversification and globalization. Strategic ways of utilizing them for poverty alleviation will be examined with particular attention given to the role of market and government.

7.1 Diversification in the study countries

Maize is extensively cultivated in the study countries and used as a material of feed. The feed industry has been developing since the 1990s onwards in the study countries. Corn starch made from maize is further processed into isomerized sugar. These new industrial uses link to the livestock and chemical industries. Soybean is processed into not only daily foods like *tempe* - a source of protein in Indonesia - but also into cooking oil through processing.

Groundnut is also consumed as oil. Recently potato has been developed as snacks and other daily dishes. Sweet potato is consumed as feed and recently attracted interest as carbon hydro material, for example, material for biodegradable plastic. Cassava also attracts large interest as an industrial material of hydro carbon. Industries of glutamine acid, alcohol or biofuel, which use such crops as input materials are expected to rapidly develop.

7.1.1 Mode of diversification and specialization

The degree of diversification, indicated by the Simpson Index, was examined in the first phase of the AGRIDIV project (see working papers of AGRIDIV Phase I). National level

^{*} Tohoku University, Japan.

diversification was calculated based on data by region. Larger countries like India and Indonesia showed a higher degree of diversification. On the other hand, the lower income countries showed a lower level of diversification. In the 1990s, Lao People's Democratic Republic and Viet Nam became slightly more diversified but Bangladesh became more specialized.

Diversification has progressed along with economic development after the success of self-sufficiency in staple foods, particularly since the 1990s in Asia. In the process of diversification, a certain crop can become intensively cultivated in specified areas where economic and agro-ecological advantages sustain the competitive position of the area rather than that of other areas. Different from Mode A depicted in Table 7.1, diversification does not necessarily progress simultaneously at all levels. Sometimes a production centre of a crop is established in line with the progress of agricultural diversification. Mutual relationships between diversification and specialization need to be checked.

Table 7.1 Diversification Mode A

Level	Diversification ← → Specialization
On-farm	← →
Regional	← →
National	← →

Table 7.2 Diversification Mode B

Level	Diversification ← → Specialization
On-farm	← →
Regional	← →
National	← →

Table 7.3 Diversification Mode C

Level	Diversification ← → Specialization
On-farm	← →
Regional	← →
National	← →

Diversification should be viewed on at least three levels, namely on-farm, regional and national. On-farm means a two-crop system or multiple crop farming with two or more different crops cultivated on a certain plot of land. Regional diversification means various kinds of crops are cultivated within a local region. The size of the region depends on the local administration system such as village, district or province. The larger the region the higher the degree of diversification should be because wider territory can include various types of agro-ecologically different sub-units. The regional level can be separated into two or more different levels, but for simplicity Tables 7.1, 7.2 and 7.3 suppose a single level.

According to our observations, diversification at all three levels (Mode A of Table 7.1) is rather rare except for large countries like India. Single crop farming is risky in the case of secondary crops. They are mostly cultivated in the dry season and in zones with less water like hilly areas. Even in an area where secondary crops are commercially and intensively cultivated, the same secondary crop is rarely cultivated two or three times a year. A few different crops are mixed per cropping season or multiple cropping is applied annually. Like Mode B of Table 7.2 farm level diversification and regional level specialization are often compatible.

An example of on-farm diversification is Myanmar farmers introducing mung bean and double cropping with rice. However, on a regional level mung bean is concentrated or specialized in certain advantageous areas (Mode B). Potato in Bangladesh also follows the same trend. Maize, cassava and soybean are widely cultivated in the study countries but demand from the processing sector contributed to the diversification at the farm and national levels. Some specific regions have become production centres for specific secondary crops.

Business opportunities brought Job's tear farming to remote mountainous regions in Lao People's Democratic Republic. The new crop induced crop diversification by adding a new crop to traditional upland crops. Consequently, a Job's tear producing centre is currently being formed, which will induce farm and national level diversification.

If both production risks and price risks are significantly small, farmers can concentrate on a single or few crops to raise productivity and seek market opportunities. This can be done in regions where transportation is well developed, access to a large consumer market is good and irrigation or other farming facilities are well equipped. In such areas or regions, Diversification Mode C can be observed. However, regional level statistics rarely identify farm level diversification. In-depth case studies at the farm level are essential to identify on-farm diversification.

If crops are better classified, we may find, for instance, a region specialized in horticulture, a region specialized in secondary crops, a region specialized in animal husbandry or others. As it is supposed to be formulated by market and natural conditions without the forced control of governments or investors, such specialization should not copy monoculture under a colonial system. Farm level or national level diversification to reduce price and production risk is supposed to build on regional level specialization.

Generally speaking, diversification and specialization are complementary. Diversification is a process to realize proper and effective use of agricultural resources at the farm, regional and national levels.

7.1.2 Prospects of industrial uses

In the study countries of AGRIDIV, industries using secondary crops as input materials are being developed in line with economic growth. Maize production in particular is required to respond to demand from feed industries, however, its yield rate in the study countries has not markedly increase in line with the demand. A marketable surplus of maize has not been possible to satisfy higher demand. Other secondary crops have also indicated the same trend. Not only quantity but also quality must be satisfied and the products of secondary crops must be properly distributed to cope with the demand from industry.

Yield rates, a sort of proxy of technological progress, were diversified among the study countries and convergence to a certain level was not observed. This reflects the diversified agro-ecological conditions, different levels of technology on farm, and many other reasons. Furthermore, many secondary crops in the study countries did not show any significant hikes in yield rate except for maize and potato. Secondary crops are not prioritized in R&D activities of each country.

Feed industries are being developed and becoming lucrative in each study country. Due to economic development, dietary patterns have diversified, particularly among the middle income class of urban inhabitants who have increased in number since the 1990s in most Asian countries. The industries can absorb so much harvested maize and soybean. The demand change has brought about a change in farming, collection and distribution, and altered the role of traders and economic structure of rural areas. Recently, secondary crops have attracted chemical industries reflecting the ethos of sustainable development through resource recycling.

In addition to these changes, under globalization, large-scale overseas markets like China and India have had a large impact on demand, global prices of secondary crops, and farming in individual producer countries. The soaring fuel prices and costly natural resources accrued to rapid demand increase for BRICs-Brazil, Russia, India and China-since 2005, which has induced strong interest in materials for biofuel such as cassava and sweet potato. The glutamine acid industry using molasses from sugarcane has developed for relatively longer and recently began absorbing cassava too as an input material.

The soybean economy of China in 2004/05 forecast by USDA, showed soybean consumption to total 39.1 million tons; 2.8 times of 1995/96 level. On the other hand, China

produces 17.5 million tons but still needs to import 24.0 million tons. The daily capacity of extracting soy oil is 150,000 tons, equivalent to USA. There are about 20 companies in the soy oil industry including grain majors like Cargill. Their average working ratio is, however, not high at approximately 50 per cent of invested capacity. It can be said that this large demand and China's trade and investment policy inevitably trigger worldwide impacts, especially on surrounding Asian countries where soybean is cultivated.

It is important to note that globalization, economic growth and industrial development have boosted the utilization of secondary crops as raw material sources and to create business opportunities in farming, primary processing and distribution. These opportunities should be effectively utilized for the poor by proper and strategic development efforts.

7.2 Framework of AGRIDIV

7.2.1 When secondary crops (CGPRT crops) become important?

Secondary crops become important and attract attention is summarized as follows: Firstly, after the success of the 'green revolution', most Asian countries achieved self-sufficiency of a staple food or, at least, retain supply capability to feed all the people of each nation. Rapid production increases are no longer a matter of utmost priority; however, nutritional balance, food security through natural disasters and quality of food have become primary concerns.

Secondly, Asian countries, mainly AGRIDIV member countries, have enjoyed rapid economic growth and globalization. Demand for food has diversified in parallel with changes in dietary patterns induced by higher incomes. Westernized dietary patterns are becoming more popular. From the view point of nutritional balance and broadening the utilization of food resources, the potential of secondary crops needs to be reexamined.

Thirdly, under governmental budget constraints, which require many governments to undertake structural adjustments led by IMF and World Bank, proper budget allocation is critical. Non urgent or redundant investment, irrigation development in particular, and staple food over supply must be avoided. Governments are often unable to allocate additional funds for the development of secondary crops. Collaborating with private businesses is strategically important to overcome budget constraints.

Under these three fundamental circumstances summarized above, secondary crops are becoming valuable and attractive commodities. We have, however, noticed that various farming skills, know how, technologies and even varieties of secondary crops retained by farmers have vanished due to the green revolution movement and subsequent development

policies that prioritized staple food self-sufficiency. Secondary crops must be reexamined from the point of not only effectiveness but also resource conservation and sustainability.

7.2.2 Why diversification of secondary crops?

The following paragraphs reveal why secondary crops should receive attention against the current backdrop.

Adapting to diversified food demand triggered by economic development in Asia

A few points are particularly noteworthy for adapting to demand side change under diversification.

Firstly, demand change is towards more non hydrocarbon resources. Demand for improving nutrition and maintaining health has become important. Soybean as a traditional secondary crop, for example, is an important source of protein for the poor. Recently, it was also acknowledged as a healthy food which supplies fibre and maintains a healthy digestive system.

Another direction of change is new uses of secondary crops as industrial raw materials such as feed, ketchup, hydrocarbon starch, etc. Recently, not only the food processing industry but also the chemical and energy industries began using secondary crops as raw materials. These industries are large scale in their operation and demand for the crops is huge. If these industries develop further to full-scale operations, farming of secondary crops should be radically changed; otherwise demand will remain unsatisfied. Demand for secondary crops is expected to become very large and the distribution system will become crucial in the future. How to cope with such change is a very important issue.

Coping with international trade under globalization

Improving economic efficiency has become essential under international free trade and globalization. No Asian county may be able to reject joining such a global economic system. Every exportable commodity could compete in the international market. Inefficient production with expensive production costs would lose competitive position in the world market and could cause unlimited inflows of foreign made commodities which inundate the domestic market and harm local farmers. Protective policies are effective in the short run but due to inefficient production in the long run the country would waste so many domestic resources that it will pay the cost in another form, more specifically budget deficits, low performance in economic growth or recession, among others. Under such circumstances is to essential take strategic policies and chose the most efficient crops or production sectors

to realize effective and sustainable use of domestic resources in the long run. R&D is the most crucial way to change the position of comparative advantage. The strategic direction of R&D, taking into consideration the domestic resource endowment, is very important.

Proper management of agricultural resources

Secondary crops are important as food in many areas, particularly in marginal areas. However, even in such areas rice or wheat has become the staple food due to the success of the 'green revolution'. Areas where secondary crops are still consumed as staple food have become very limited. Even in areas where rice or wheat farming based on irrigation is not appropriate, unified rice or wheat farming systems were introduced and worsened agro-ecological conditions. A typical problem is salinity in the semi-tropics where farming land becomes soursed by irrigation water.

Secondary crops contain many kinds of protein, fat, minerals and vitamins which are important from a nutritional point of view. Various genes of secondary crops could represent future resources for bio-science and other related sciences. However, rice-wheat biased development has reduced the farming area of secondary crops and rendered traditional knowledge and skills obsolete. Considering the recent development of bio science and industrial uses of secondary crops, seed resources - in other word genes - farming technologies and agro-ecological conditions should be retained for future use. In this sense resource management for the sustainable use of secondary crops should not be overlooked.

Exploring economic opportunities and improving the accessibility of the poor to markets

Exploring economic opportunities is essential to create employment opportunities and raise the income level. Self consumption of secondary crops can raise the income of poor farmers, particularly in remote or marginal areas where secondary crops are staples. Secondary crops should not be overlooked. Nonetheless, farmers and local governments have been slack in discovering innovative economic opportunities utilizing secondary crops. New demand for secondary crops should stem mainly not from governmental administration but from the markets. Private businesses such as local traders or entrepreneurs are major players in local markets who can identify new business opportunities and utilize secondary crops. To explore new economic opportunities, institutional arrangements aimed at enhancing market mechanisms and assisting farmers and local people access the market represent the most important development strategy.

In the context of alleviating poverty through secondary crops, the most important strategy is to explore economic opportunities through the utilization of secondary crops. The principles of the strategy should be; (i) make CGPRT crops become useful resources; (ii) generate employment opportunities; (iii) mitigate production and price risks; and (iv) raise the income of the people. Efforts to combat poverty may comprise of these principal objectives. The key to the realization of the objectives is full utilization of market opportunities.

7.2.3 Who should explore and utilize the opportunities of secondary crops?

Business opportunities should be properly identified and exploited by market players, namely, traders and/or entrepreneurs who understand well the various conditions and constraints in the market and also take countermeasures to overcome them. Private businesses comprising of numerous decision actors seems to have advantage here rather than centralized government entities. A business always entails risks, but most risk can be reduced to some extent by government support. Government participation as a player should be limited to the extent that the power of private businesses is not held back and can therefore play an important role in regulating the market system. The government should not make business decisions but act as facilitator for market players.

There are many traders (collectors, middlemen, rice millers, exporters) and owners of local processing firms. They can be local entrepreneurs and conduct business close to locally available resources. It is essential to induce such entrepreneurs to secondary crop resources and realize alternative and new uses of them. Utilizing their knowledge and experience in local areas is a practical and effective development strategy.

7.2.4 What are the conditions necessary to enhance the private sector?

Private business may have more advantage than the government in considering the various constraints or conditions confronted. The feasibility of business may roughly depend on the availability of the following;

- Market opportunities and information;
- Capital;
- Technology;
- Entrepreneurship, ability; and
- Government support.

7.2.5 How to promote effective use of secondary crops?

Promoting the effective use of secondary crops comprises a basic step and strategic step. The basic step covers two fields of activity. First is to explore new uses of secondary crops. Second is to develop appropriate processing so to add value to the products.

The strategic step includes the participation of the private sector. Promoters of the secondary crop based economy are not only farmers or government, but also private businesses, for examples, local traders and processors. They can be very active and access new information, new technology and financial sources. Taking advantage of this they can identify economic opportunities and create new businesses in markets facilitated by the government. In this regard, role sharing between market and government is important to propel the effective use of secondary crops. The government still has a crucial role not only in providing public goods such as road and information infrastructure but also arranging market institutions which regulate and facilitate business activities. The government needs to realize the laws of one price in any market, to support entrepreneurial activities and reduce the various risks.

7.3 Development strategy of secondary crop based economy

Diversification does not simply mean increasing the number of varieties of crops in farming. Diversification of food consumption provides new farming and business opportunities to secondary crop farmers. Diversification should be fully utilized by the farmers and local people to increase their income level and create employment opportunities. Secondary crops can be expected as resources to achieve sufficient food, proper nutrition, exploring new uses and processing, increasing demand, reducing the financial burden of the government, improving terms of trade for farmers, and reducing poverty. These potential roles can be realized by a well designed development strategy.

The other outputs of the AGRIDIV project, published as working papers, focus on the role of the government, particularly the provision of public goods and R&D activities for the development of secondary crops. Being different from the other outputs, this paper gives greater importance to the impacts of economic development, diversification of food consumption, globalization and budget constraints of each government. This paper takes a strategic point of view and takes note of market characteristics and market players.

7.3.1 New demand dimension

There are at least two dimensions of consideration in coping with demand side changes. The first dimension is new or exploitable demand comprising three basic types,

namely: (i) new consumption as food with processing; (ii) raw materials for industry; and (iii) export market.

The second dimension concerns demand with non-scale or scale economy: (i) small-scale local consumption and processing is generally supposed to be non-scale economy; but (ii) large-scale industrial use should be with scale economy and with large-scale collection. Large-scale and hierarchical distribution systems are essential to realize the large-scale industrial use.

7.3.2 Essential conditions

The following three issues are essential conditions to cope with new demand, in particular derived from the industrial sector:

1. Scale economy of large processing enterprises;
2. Stable regulated supply; and
3. Quality standards.

It is crucial for a processing unit with a scale economy to maintain a certain level of operation which minimizes production costs and maximizes profit. Operation stoppages due to delay of material procurement cause large profit losses. Secondary crops are usually produced by many numbers of small farmers under the non-scale economy. An efficient and stable collection system is very important to guarantee the regulated operation of processing units. The lack of efficient large-scale collection centres inhibits the large-scale industrial use of secondary crops. Stable and efficient supply of input materials is essential to maintain stable operations.

Good quality materials are also essential to realize the efficient operation of business. The purity of material, regulated level of moisture content and others must be satisfied. It is very hard to satisfy the quality conditions of large-scale collectors from very many small farmers. Quality control in a large-scale collection system must receive high priority to realize effective use of secondary crops in the industrial sector.

Mutual co-operation among farmers, traders, processing units and the government is essential to realize large-scale collection, maintain the quality standards required by processing units and stabilize processing units with a scale economy.

7.3.3 Role sharing between market and government

Public or quasi-public goods such as transportation and market facilities, credit programmes for agricultural development, etc. are usually supplied by the government, however, the government should facilitate market mechanisms and provide technological

and financial support required by farmers, local traders and processing units.

The most fundamental role of the government as facilitator is to bridge the gap between the scale economy sector and non-scale economy sector. The government has conventionally supplied public goods and the fruits of R&D, because these fields require large-scale investment for facilities and human resources such as scientists.

It is unaffordable for small-scale farmers, traders or processors to invest in large-scale businesses and subsequently obtain higher profits. Financial and technological support from the government would stimulate market players. Improving market institutions which bolster the market and foster local human resources is the essential role of the government.

7.3.4 Role of local government

Not only the central government but also local authorities share the important role of implementing government policies, because they directly contact and lead local people towards development. Local governments, however, sometimes have the wrong perception of the development idea. Participation, empowerment and improving accessibility to market opportunities are recent central ideas for development. However, when local authorities confront tangled problems related to the vested interests of many local groups, solutions are not always obvious and the development ideas are improperly applied.

Processing and opportunities

The following anecdote is based on a case study of a travelling rice miller in Indonesia. Rice is not a secondary crop but it is helpful to understand the role of local governments and the constraints faced. It concerns a change brought about by demand for a new service to be provided by travelling rice millers in villages in rural Java.

1. Local government did not support the travelling millers but did existing rice millers who were rich and influential in local politics.
2. Young and poor entrepreneurs could not access bank credit due to lack of license and collateral.
3. They needed to borrow money from money lenders who had other businesses and could borrow from the banks.
4. Credit rationing appeared due to the lack of proper policy support for new business models created by local young entrepreneurs who were mostly young landless people.
5. Local government attitude deprived the opportunity of:

- Entrepreneurs to create and utilize new opportunities and contribute to local development; and
- The development of a rural financial market.

Our observation in rural Java suggests the following two points which should be taken into account. Firstly, local governments can precisely understand the endowment of local resources. In line with decentralization, local markets should be activated so as to enable proper and effective use of the secondary crops which are largely cultivated in marginal areas. Secondly, appropriate credit policies should facilitate market access to small farmers, local traders and processing units, and support the development of a rural financial market without credit rationing.

7.4 Market, price and inter-country co-ordination

Globalization in developing economies should be considered as a market opportunity for secondary crop farmers living in disadvantaged areas. For full-scale utilization of market opportunities, development policies for secondary crops need to pay attention to the following activities:

7.4.1 Activating and accelerating the role of local markets

Market mechanisms are supposed to be the most effective means to utilize the potential value of secondary crop resources. Market players and market institutions are important components of the market system in addition to market infrastructure. The following four points are necessary for a government to effectively activate and accelerate market mechanisms: (i) identify local entrepreneurs who utilize secondary crops; (ii) induce and commit them to the development process of poverty alleviation; (iii) maintain competitiveness among market players to avoid their monopolistic attitude; and (iv) each government should not influence competition among market players for the protection of the poor, because such protective policies sometimes separate the poor from the markets and reduce their accessibility to market opportunities.

7.4.2 Mitigating price and production risks for the poor

Price fluctuations in the global market can directly affect rural areas where globalization and commercialization have prevailed. Various internationally traded commodities in large markets tend to be correlated to each other due to international market conditions such as oil price hikes, wars and others. If most crops produced in a certain area

are correlated by price, mitigating risk could be very difficult. Consequently, effectiveness of diversification is diminished.

To mitigate the risk of poor farmers, mixed farming technology is essential to promote diversification at the farm level, but price correlation should be considered and crops without price correlation should be selected, particularly for the poor.

7.4.3 Mitigating foreign exchange impacts and other macroeconomic risks

Under globalization and the deregulation of an economy, exchange rates have substantial and direct impacts on the price of secondary crops, farmer income and their Domestic Resource Cost (DRC). If the exchange rate of domestic currency appreciates, the added value of domestic crops increases and their DRC values rise. This change reduces their competitiveness in the global market. A DRC value of more than one implies that a country should import the crop from overseas markets instead of producing domestically. The country should produce another crop or reallocate production to other sectors of the economy. Under globalization and a floating exchange rate system, exchange risk inevitably and largely affects secondary crop producers. It is important to jointly discuss countermeasures to international market conditions, to obtain information regarding exchange rate fluctuations and the agricultural policies of other countries as well as explore ways of coping with changes in international conditions.

Foreign exchange depreciation is sometimes unavoidable due to foreign shocks or policy failure. In such cases, some exportable commodities become valuable and suddenly increase their export volume. Such crops can earn windfall gains but they also bring economic instability and often exacerbate agricultural conditions such as soil fertility through exploitative farming.

7.4.4 Establishing international platform for co-ordination

Under globalization and the growing constraints of agricultural resources such as water, soil, climate and property rights, regional co-ordination among the eight study countries is useful and beneficial not only for food security but also to avoid wasteful resource use.

DRC analysis compares resource use of labour, land and capital. Secondary crops are more labour intensive in poor regions and, as such changes in wage levels critically affect the DRC level. Land rent rates as well as wage rates have rapidly increased due to industrialization and urbanization and these changes inflate the DRC and reduce competitiveness. Cheap labour and low land rent are the main basis of high

competitiveness of secondary crops in marginal areas where economic opportunities are limited.

If the data of DRC by local region of each country was available, the competitive position of each local level could be comparatively analysed. DRC analysis is helpful to design a policy for production and other related policies not only for a country but also for international arrangements between participating countries. National level calculations do not necessarily correlate to local level DRC calculations, particularly under the diversification of agriculture. Local-based analysis has shown that some local areas in different countries can remain competitive even if the national DRC is above one and less competitive. This enables a country to formulate strategic policies and reduce the wasteful use of domestic resources.

Such policy-making is more effective through joint study, information exchange and discussion. In Table 7.4, Bangladesh, Indonesia, Myanmar and Sri Lanka show relatively good competitive position in the global market but the levels are diversified by local region.

The table indicates that maize and soybean of some regions of Viet Nam are competitive in overseas markets but those of the other regions are not. The Government of Viet Nam needs to carefully consider local conditions and properly use domestic resources by region to implement its diversification policy. It is costly to apply unified policies nationwide. Export promotion in a country can exacerbate secondary crop production in other countries. Without proper policies, exports of secondary crops could result in exporting poverty to other countries. Such impacts are avoidable through proper and well co-ordinated policy among the related countries. Establishment of a platform to communicate and co-ordinate among countries is useful to mitigate unnecessary waste of resources in developing countries.

Table 7.4 Domestic Resource Cost (DRC) by country

	Maize	Finger millet*	Mung bean	Black gram	Soy-bean	Groundnut	Lentil	Potato	Cassava
Bangladesh	0.639	0.491					0.615	0.147	
India									
Indonesia	0.37-0.65				0.75-1.15	0.57-0.97		0.339-0.881	
Lao PDR									
Myanmar			0.65-0.74	0.19-0.55					
Sri Lanka	1.24	1.92	0.56	1.44	1.29	1.85		1.03	0.51
Thailand			1.162-1.811		1.204-1.454				
Viet Nam	0.78-1.09				0.98-1.30				

Source: From each country study report of AGRIDIV.

Note: – means regional variations.

* millets in the case of Bangladesh.

7.5 Conclusion

Implications drawn from this chapter can be summarized as follows:

Firstly, secondary crop farmers are mostly poor and live in remote, marginal areas in Asia. Without the proper utilization of secondary crops, poverty alleviation in developing Asia is an unobtainable target. In Asia, ongoing agricultural diversification is agreeable for extending secondary crop use and exploring their potential. This is the most important pulling factor for enhancing the secondary crop based economy. Secondary crops can support poor people in coping with rapid economic development and globalization and as well as raise their income by effectively utilizing various opportunities.

Second, new industrial uses are increasing and have great potential. Considering recent industrial use, all secondary crops have same potential of innovative uses in the future. It is hard to forecast which and how secondary crops will be utilized. At least from the supply side, the development of secondary crop production should be enhanced by improving the accessibility of the poor to the market. If conducive conditions prevail, even poor people can effectively respond to demand from the market.

Third, to improve of market mechanisms, governments should facilitate the market system; not as a player. Governments should limit their role to making the market system work well and supporting local businesses and farming. Governmental support, such as, improving market infrastructure, providing market information and others can provide good incentives to accelerate local peoples' activities in utilizing secondary crops.

Finally, under globalization, individual countries try to increase their exports of competitive products in the overseas market. Through competition in overseas markets, individual countries must respond strategically to market conditions and examine other profitable and exportable crops. Policy co-ordination for appropriate resource use among AGRIDIV member countries should be fruitful. To create a platform to enable communication among the countries is very effective to reallocate resources beyond national boundaries and utilize resource use in the region.

References

- Alam, J., 2005. Enhancing Sustainable Development of Diverse Agriculture in Bangladesh. CAPSA Working Paper No. 80, Bogor, Indonesia: UNESCAP-CAPSA.
- Ali, Mubarik; Farooq, Umar; and Abedullah, 2005. Food Security through Pulses in South Asia: A Neglected Frontier. Paper presented at the Regional Workshop entitled 'Rural Prosperity and Secondary Crops towards Applied Pro-Poor Research and Policies in Asia and the Pacific' held at UNESCAP CAPSA from 6 through 9 December 2005.
- Anh, Dao The; Thinh, Le Duc and Binh, Vu Trong, 2005. Enhancing Sustainable Development of Diverse Agriculture in Viet Nam. CAPSA Working Paper No. 86. Bogor, Indonesia: UN-ESCAP CAPSA.
- Douangsavanh, Linkham, Bouaham, Bounthong and Pouyavong, Khamphou, 2006. Enhancing Sustainable Development of Diverse Agriculture in Lao People's Democratic Republic. CAPSA Working Paper No. 89, Bogor, Indonesia: UNESCAP-CAPSA.
- Kyi, Aung, 2005. Enhancing Sustainable Development of Diverse Agriculture through CGPRT Crops in Myanmar: Current Status of CGPRT Crop Agriculture and Identification of Its Development Constraints. CAPSA Working Paper No. 85, Bogor, Indonesia: UNESCAP-CAPSA.
- Mahrouf, A.R.M., 2005. Enhancing Sustainable Development of Diverse Agriculture in Sri Lanka. CAPSA Working Paper No. 83, Bogor, Indonesia: UNESCAP-CAPSA.
- Ostrom, Elinor, Schroeder, Larry and Wynne, Susan, 1993. Institutional Incentives and Sustainable Development. Boulder, CO: Westview Press.
- Roonaphai, Nareennat, 2006. Enhancing Sustainable Development of Diverse Agriculture in Thailand. CAPSA Working Paper No. 90, Bogor, Indonesia: UNESCAP CAPSA.
- Singh, R.P.; Singh, N.P.; Kumar, Ranjit, 2005. Enhancing Sustainable Development of Diverse Agriculture in India. CAPSA Working Paper No. 82, Bogor, Indonesia: UNESCAP CAPSA.
- Upho, Norman (ed.), 2002. Agroecological Innovations: Increasing Food Production with Participatory Development. London: Earthcan Publications.
- World Bank, 2000. Attacking Poverty. World Development Report 2000/2001. Washington D.C., USA: World Bank.

8. Policy Recommendations and Conclusions

*Tomohide Sugino**

Based on the country study results during Phase I and II, policy recommendations were formulated by the country study teams in the eight participating countries. As a conclusion of the project, this chapter presents an analysis of the policy recommendations which were classified into ten categories, namely (i) Technological development; (ii) Marketing; (iii) Infrastructure and information; (iv) Credit; (v) Processing; (vi) Price and trade; (vii) Inputs; (viii) Regional co-operation; (ix) Farmer groups; and (x) Land policy.

8.1 Technological development

Previous experience of technology development has shown that technology itself cannot necessarily solve the problem of poverty. Even so, nearly one-third of policy recommendations in the country studies are related to technological issues. They consist of various items from individual technology development to solve a specific problem to institutional renovation of research and development (R&D) systems including linkages between research and extension.

Technology development for secondary crops in the region is still at a very formative stage. In most Asian countries, R&D concentrates on major cereals, especially rice. Technological development for secondary crops has been very low mainly due to limited financial resources. For example, in Myanmar, only less than 1 per cent of total expenditure of MAS (Myanmar Agricultural Service), which is the main technical body for the Ministry of Agriculture and Irrigation, is allocated to CARI (Central Agricultural Research Institute), which is responsible for research on secondary crops (Kyi, 2005). However, thanks to this 'neglect', technologies for secondary crops still have room to be developed, while the yield increase in rice is facing stagnation, in spite of continuous research efforts.

Most country studies concluded that the government should increase its budget allocation to secondary crop related R&D activities. This recommendation is based on the higher profitability and comparative advantage of secondary crops over major cereals,

* JIRCAS, Japan.

especially in rainfed upland areas. For example, the results of economic analysis in Indonesia indicated that all secondary crops, except soybean have comparative advantage. From a sensitivity analysis, it was also concluded that the comparative advantages of maize and groundnut are relatively stable towards changes in import parity prices or changes in yields (Siregar, 2006). Considering that rice is a strategic commodity in the context of food security in the region, proposals to shift R&D focus from rice to secondary crop development might not be warmly welcomed, unless concrete evidence for the usefulness of secondary crops is shown. Therefore, it is important to disseminate the findings of the project, which illustrates the positive impacts of secondary crops on the welfare of rural poor farmers.

As mentioned in the recommendations of Lao People's Democratic Republic, a comprehensive approach is necessary, which includes measurement to maintain productivity of rice as well as to improve the production system of secondary crops. Food diversification, which means diversification of dietary patterns from rice centred to a combination of various alternative staple foods, will be another way to reduce pressure of rice production. However, previous experience has shown that successful cases of food diversification have rarely been observed except in developed countries where successfully people increase their consumption of meat, fish, fruit, vegetables and other high value commodities whilst decreasing staple food consumption. This policy needs time to be successful until the consumers in the region have sufficient purchase power for high value commodities. Therefore, efforts to increase productivity of rice should be also continued to ease the pressure on rice production and provide farmers with land for secondary crop production.

Most of governments in the Asian developing region face financial difficulty and it is unrealistic for them to meet all the technological development needs with the limited financial and human resources. Therefore, prioritization of R&D topics is important to proceed with technological development effectively. According to the results of the questionnaire survey conducted (see Chapter 6), policy planners in the participating countries, technologies to improve soil fertility with local resources (green manure crops, compost, etc.) and the development of varieties with high pest tolerance, both of which can reduce chemical fertilizer and pesticide inputs are recognized the most important technologies of the major R&D topics for agricultural diversification. The results reflect the features of agriculture in Asian developing region, namely the existence of excess labour in rural areas and a lack of capital to improve agricultural production. These 'cost saving technologies' should be prioritized in R&D activities in the region (Box 8.1).

Box 8.1 Summary of recommendations (Technology development)

<p>(Priority of R&D topics)</p> <ul style="list-style-type: none">➤ For appropriate policy decisions, profitability analysis, marketing research and demand projections are necessary at regular intervals (Bangladesh).➤ Efforts should be made for the collection and preservation of germplasm of secondary crops to save them from the threat of possible extinction (Bangladesh).➤ Genetically modified high-yielding cultivars suiting marginal production environments are an effective option (India).➤ Rising of paddy/rice consumption, which is linked to population growth, could be met through increased unit yield (Lao People's Democratic Republic).➤ Mechanized farming is required to reduce production costs and boost work efficiency (Lao People's Democratic Republic).➤ Research activities for income improvement in shifting cultivation areas to stabilize shifting cultivation (Lao People's Democratic Republic).➤ Replacement of low potential/pest susceptible older varieties with newer, high-yielding varieties (Lao People's Democratic Republic).➤ Better crop management with popularization of line sowing and adoption of other management technologies (Lao People's Democratic Republic).➤ Development of location-specific crop production technologies, especially through the adoption of non-monetary inputs (Lao People's Democratic Republic).➤ The identification and selection of appropriate rhizobium strains, which are variety-specific for high yield and effective inoculums (Myanmar).➤ Soil conservation and fertility improvement such as construction of low-cost check dams for soil erosion, use of organic matter mixed with nitrogen containing chemical fertilizers, etc. (Myanmar).➤ Cassava and maize production technologies on sloping land for the sustainability of the production system should be developed (Viet Nam).
<p>(Institutional support)</p> <ul style="list-style-type: none">➤ Efforts should be made to disseminate research findings to farmers regularly through the extension system. Training programmes for extension agents should be arranged (Bangladesh).➤ To improve professionalism, it is essential to design a system of motivating the researchers (Indonesia).➤ Action should be taken at the national level to promote the adoption of recommended technology packages by farmers to enhance secondary crop productivity (Sri Lanka).➤ Extend the learning process by transferring the ideas of farmers who have succeeded in diversifying their production systems (Thailand).

Processing technologies are included in Box 8.5.

Source: Author compiled based on AGRIDIV country study reports in eight countries.

8.2 Marketing

One of the common problems of secondary crop marketing in the participating countries is high marketing costs or inefficiency in the commodity chains. This is mainly

because the marketing systems for secondary crops are yet well developed while major crops can enjoy governmental support such as infrastructure and the provision of market information.

As a solution to this problem, contract farming is recommended in most participating countries. Contract farming can provide mutual benefits to both producers and consumers, if it is effectively worked. However, the partnership between both parties is not easy to develop. For example, farmers are sometimes suspicious of the way processors determine the quality of crops such as moisture and starch content of cassava, while the latter may impose higher price cuts on the grounds of low crop quality, which is sometimes difficult to justify to farmers (Siregar, 2006). Though contract farming is a purely private commercial activity, well controlled governmental intervention is required until the system matures. To formulate mutual trust between the parties, government intervention is necessary by making clear and fair rules for contract farming and providing a monitoring system for the contract in its formative stage (Box 8.2).

Box 8.2 Summary of recommendations (Marketing)

<p>(Contract farming)</p> <ul style="list-style-type: none">➤ Newer options like contract farming co-operatives and group action may lead to better opportunities to augment farm income (India).➤ The forward sales contract (FSC) system should be expanded to overcome marketing constraints (Sri Lanka).➤ In the context of smallholders, contract farming should be developed closely with farmer organizations (Viet Nam).
<p>(Others)</p> <ul style="list-style-type: none">➤ Enhance market information access to credit for those who are willing to enter the marketing business, to increase marketing efficiency (Indonesia).➤ It is necessary to find a place in the export market for new species of pulses other than the existing traded species, which are commonly traded by other countries (Myanmar).➤ Regarding the OTOP project aiming to raise the income of rural families, the government is urged to enlarge the marketing network from the local level up to the national and export levels (Thailand).➤ The establishment of product traceability by Protected Designation of Origin (PDO) or Geographical Indication (GI) is a means to improve quality (Viet Nam).

Source: Author compiled based on AGRIDIV country study reports in eight countries.

8.3 Infrastructure and information

Most recommendations concerning infrastructure development consider irrigation facilities. Reflecting the fact that large-scale irrigation development is difficult to develop due to financial and environmental reasons, the recommendations focused on small-scale irrigation schemes using tube wells and small tanks which can be developed and managed by rural poor farmers with proper financial and technological support by the government. Storage facilities are another focus of secondary crop development. Since most poor secondary crop farmers lack storage facilities, they are forced to sell their products immediately post harvest. This deprives the farmers of their liberty to decide when to sell their produce, resulting in lower income.

Provision of information about secondary crops is also a major concern in many countries, in particular price and market information to help farmers decide when to harvest their crops to maximize profit. The necessity of technological information such as quality is also suggested in several countries from the view point of fair trade between farmers and processors (Box 8.3).

Box 8.3 Summary of recommendations (Infrastructure and information)

<p>(Irrigation)</p> <ul style="list-style-type: none"> ➤ Small-scale irrigation to satisfy the water requirement of secondary crops, which is usually less than rice, should be promoted (Bangladesh). ➤ In the dry season, better maize yield is expected because of less disease and pest problems. Area under irrigation should be increased to promote dry season maize (Lao People's Democratic Republic). ➤ State assistance should be provided to encourage the cultivation of secondary crops with irrigation through agro-wells and under minor irrigation systems (Sri Lanka). ➤ Building smaller scale irrigation facilities for secondary crops would save budget and involve no foreseeable conflict with the public. Also, building farm ponds must employ water management and appropriate crop selection (Thailand).
<p>(Other infrastructure)</p> <ul style="list-style-type: none"> ➤ Storage facilities, especially cold storage for tuber crops should be improved to save products from post-harvest losses (Bangladesh). ➤ Better market mechanisms, roads, processing facilities and other appropriate infrastructure should be developed to ensure the long-term diversification of secondary crops (India). ➤ Planning for infrastructure construction should be well organized to eliminate repetition in operations and budgeting (Thailand).

Continued

Box 8.3 Summary of recommendations (Infrastructure and information) (continued)

(Information)

- Local governments should provide farmers with information that may disclose all information on how processing firms weigh and determine the quality of secondary crops to reduce transaction costs (Indonesia).
- It is necessary to establish agricultural market information services for producers, traders, exporters and consumers through the mass media to promote domestic and international marketing of secondary crops (Myanmar).
- A crop production and market price forecasting system should be established (Sri Lanka).
- Local governments should deliver market information to support small-scale processors in their marketing (Thailand).

Source: Author compiled based on AGRIDIV country study reports in eight countries.

8.4 Credit

Due to the limited availability of formal credit, secondary crop farmers, especially those who are without solid financial background, have to rely on informal lending sources and consequently pay high interest rates, which squeezes the slight profit that the farmers earn from production (Kyi, 2005). To solve the problem, various credit schemes for secondary crops were recommended in the country studies. It includes extending the terms of repayment, which are mostly limited to the length of one cropping season or at most one year in many credit schemes, in order to promote long-term investment in secondary crop based agriculture.

The key for success to expand accessibility of credit will be to secure the guarantee of repayment. Since most secondary crop farmers are resource poor, creditors are usually suspicious whether the debt can be repaid. Microfinance schemes, which formulate farmers groups as recipients of the credit, already popular in Bangladesh, are one solution to reduce the number of default cases.

Small-scale farmers often face difficulty in securing collateral when they access credit schemes. 'Storage-cum-credit scheme' is a unique approach to solve the problem, which allows farmers to borrow from banks for their urgent needs, while using stored commodities as collateral (Alam, 2005). Additional efforts to improve credit conditions will also be useful such as publishing certification for access to credit, stabilization of the banking system and adjustment of the exchange rate (Box 8.4).

Box 8.4 Summary of recommendations (Credit)

<p>(Access to credit)</p> <ul style="list-style-type: none"> ➤ A special credit programme, especially microfinance scheme should be launched for the production and processing of secondary crops (Bangladesh). ➤ Improving farmers' accessibility to credit for secondary crop production (Indonesia).
<p>(Credit scheme for a specific purpose)</p> <ul style="list-style-type: none"> ➤ The storage-cum-credit scheme now under operation through the Department of Agricultural Marketing should be extended to secondary crop growers so that they can store their commodities and borrow from banks to meet their urgent cash needs (Bangladesh). ➤ Working capital is the major factor affecting farmers' decision about cropping pattern. Farm inputs should be subsidized and farmers' access to cheap credits improved (Indonesia).
<p>(Others)</p> <ul style="list-style-type: none"> ➤ Since a land certificate is required to be accepted for credit from the banks, the National Agency for Land Certification (BPN) should accelerate a Low-Cost Land Certification Programme (Indonesia). ➤ It is necessary to improve banking and financial sector stability (Indonesia). ➤ Huge differences between the official exchange rate and parallel market rates should also be unified while stabilizing the exchange rate (Myanmar). ➤ Along with the improvement of MADB (Myanmar Agricultural Development Bank) operations, promoting the involvement of private banks in agricultural financing and designing small-scale credit schemes would benefit rural people (Myanmar). ➤ Amend the Village Fund's rules to extend farm loans to more than one year's terms. A refinancing programme should be adopted to allow farmers to re-borrow to repay farm debt and a longer-term loan for new investment. The village committee/farm group members should work as credit supervisors having government agents attached (Thailand).

Source: Author compiled based on AGRIDIV country study reports in eight countries.

8.5 Processing

The recommendations regarding processing focused on small-scale processing in rural areas. There are several benefits of promoting small-scale processing rather than large scale, in the context of poverty alleviation. Development of small-scale processing units can improve marketing efficiency of secondary crops because the distance from farmers to the processing units becomes shorter and does not involve middlemen (Siregar *et al.*, 2006). Traditional processing devices create employment opportunities for rural people, particularly women (Alam, 2005), who are more vulnerable to poverty in rural areas.

Most secondary crops excel in nutrient value, compared to major cereals. Millet contains twice the energy, four times the protein and nine times the fat of rice. Mungbean contains three times more iron than spinach (calculated by the author based on JST, 2005). It is useful to facilitate the media (radio, television, newspapers, etc.) to focus on the utility of

secondary crop products as nutritionally rich foods and inform people about the versatile uses of these crops (Alam, 2005).

In addition to the above mentioned conventional processing, modern processing such as biodegradable plastics and biofuel will also be effective in raising demand for secondary crops. Though only the country study in Thailand mentioned that as the global oil price becomes more expensive, production should be expanded to produce more ethanol (Roonnapai, 2006), this issue should be more focused in future policy planning in the region (Box 8.5).

Box 8.5 Summary of recommendations (Processing)

(Small-scale processing)

- Providing needed impetus for effectively canalizing maize produce to the various post-harvest uses by establishing small-scale, post-harvest manufacturing units in the hinterlands. This will not only provide incentives to the producers by way of commensurate prices, but will also smoothen the marketing and disposal hassles (India).
- It is necessary that local government rehabilitate ITTARA (small-scale cassava processing programme) units. Rehabilitation of each ITTARA unit should be based on a comprehensive benefit-cost study and through participatory approach involving local communities (Indonesia).
- Develop agro-based industries at the cottage level as well as at the large-scale commercial level through incentives and concessions to stakeholders (Sri Lanka).

(Processing technologies)

- Attention should be given to modernization and capacity utilization of processing mills and plants (Bangladesh).
- Commercial uses of secondary crop products for animal feed and as raw materials for industry have to be researched and encouraged (Bangladesh).
- Since global market demand for processed products is increasing, Myanmar has to learn the processing technology and find market places for processed forms of pulses (Myanmar).
- As production potentials exist for maize, research on maize processing for non-food industries is suggested to be supported (Thailand).
- Research on maize processing should be supported as almost all maize production currently goes to the mills (Thailand).
- Agro-processing will create employment in rural areas. The introduction of varieties adapted for processing and for the export market is important. There is also demand for the improvement of equipment and institutions for better quality management in the agro-processing chain in order to match high quality markets (Viet Nam).

Continued

Box 8.5 Summary of recommendations (Processing) (continued)

<p>(Quality of products)</p> <ul style="list-style-type: none"> ➤ People need to be made more aware of the high calorie and protein content of secondary crops. Different processed food has to be promoted to make them popular under initiatives both public and private (Bangladesh). ➤ The mass media should come forward to focus on the utility of secondary crop products as nutritionally rich food and inform people about the versatile uses of secondary crops (Bangladesh). ➤ Small-scale processing firms should maintain the sanitary standards of their products. They should be registered and organized into co-operatives. Loans with simple terms with a low rate of interest should be provided (Bangladesh). ➤ Most processed pulses are below international standards in quality and this hinders development of viable agro-based industries. The development of viable agro-based industries remains essential in creating employment and raising the living standards of the rural populace. FDI could be the only way to improve the situation at the moment (Myanmar).
<p>(Modern processing)</p> <ul style="list-style-type: none"> ➤ To increase the demand for secondary crop commodities, the government should accord high priority on research and development for industrial uses of secondary crops e.g. the use of sweet sorghum for biofuel (Indonesia). ➤ Regarding cassava, as the global oil price becomes more expensive, production should be expanded to produce more ethanol (Thailand).
<p>(Institutional support)</p> <ul style="list-style-type: none"> ➤ The Ministry of Agriculture should have a separate division to facilitate and monitor agro-processing activities in the country. It should co-ordinate such activities with other departments and ministries (Bangladesh).
<p>(Others)</p> <ul style="list-style-type: none"> ➤ An appropriate system to ensure easy access to imports and use of processing machinery and equipment should be developed (Sri Lanka).

Source: Author compiled based on AGRIDIV country study reports in eight countries.

8.6 Price and trade policy

All the participating countries lack price policies which effectively support secondary crop farmers, meanwhile such support is available for major cereals. Price support is an effective way to promote secondary crop production and stabilize or increase farmers' profit. However, if considering the current financial burden of each government, it is less relevant to recommend the establishment of another price support scheme which increases the financial burden. One of the practical options would be to reduce the current price support to major cereals to provide incentives for farmers to shift their cropping pattern from rice monoculture to diversified cropping patterns. Price support policy as well as relatively higher import tariffs on major cereals result in a huge cost to society in the form of net welfare loss. Lower rice prices induced by the ban of these policies also cause real wages to increase

without any increase in nominal wages paid by employers in non-agricultural sectors. In other words, the combination of relatively low nominal wages and high real wages would stimulate job creation and economic growth that are absolutely necessary for sustainable poverty alleviation (Siregar, 2006). Of course, this option should be carefully designed since rice is a strategic and sometimes political commodity (Box 8.6).

Box 8.6 Summary of recommendations (Price and trade)

<p>(Price policy)</p> <ul style="list-style-type: none"> ➤ A rational price policy should be formulated to ensure remunerative prices to secondary crop growers as well as major cereal growers. This can be made effective through the procurement of produce by the government from the growers and distribution to the consumers in open-market sales. To this end, the procurement price should be determined ahead of harvest. An agricultural price commission should be formed to recommend procurement prices and regularly monitor price fluctuations (Bangladesh). ➤ Price support policies for rice should be removed (Indonesia).
<p>(Trade policy)</p> <ul style="list-style-type: none"> ➤ Farmers should be protected from international competition through the imposition of high tariffs on imports of secondary crop products, particularly on imports of maize and pulses (Bangladesh). ➤ Duty on imported raw materials used for producing snacks at home should be reduced. On the other hand, supplementary duty should be imposed on imports of finished products. This would make domestic products more competitive in the market (Bangladesh). ➤ Cash incentives should be introduced for exports of products made from secondary crops like vegetables which are given a 30 per cent cash incentive for export (Bangladesh). ➤ Import tariffs and import bans for rice be removed such that farmers have less incentive to grow rice (Indonesia). ➤ Import tariffs should be imposed on wheat so that food diversification would be mostly based on domestic production of secondary crops (Indonesia). ➤ The national tariff structure should be amended in order to restrict the import of secondary crops and ensure better producer prices to domestic products (Sri Lanka). ➤ Non-tariff measures such as limit of toxic substances in crops or agro-processing products, sanitary and phyto-sanitary measures (SPS), Good Agricultural Practice (GAP), GMP and HACCP should be fairly applied to imports in order to prevent trade deterioration. In the FTA, Mutual Recognition Agreement (MRA) should be settled bilaterally (Thailand). ➤ Enhancing trade management capacity on agricultural products for both state and commodity chain stakeholders is necessary for the international trade rules in the negotiations (Viet Nam).

Source: Author compiled based on AGRIDIV country study reports in eight countries.

8.7 Input

The recommendations for input use mainly focus on fertilizers and seeds. Lack of effective marketing systems and farmers' access to credit to purchase inputs are the major impediments for securing adequate input supply. Poor farmers do not use the required

material inputs for crops due to their financial inability (Alam, 2005). It is also reported that there are shortages of improved seeds and planting materials to promote crop diversification, due to the absence of private input suppliers and the high price of imported materials (Douangsavanh *et al.*, 2006).

As countermeasures to these problems, subsidy schemes are recommended in several countries. The input use for secondary crop production is still low. Therefore, the output which will be expected by greater of input use is relatively higher than major cereals. It is useful to evaluate the benefit of input use to convince the relevancy of the subsidy schemes. In addition to the institutional measurements, technological issues such as site-specific fertilizers to save input use and the promotion of organic material use by establishing farmer groups to conduct collective activities to produce green manure are also effective and more economical ways to solve the problems (Box 8.7).

Box 8.7 Summary of recommendations (Inputs)

<p>(Input policy in general)</p> <ul style="list-style-type: none"> ➤ Special subsidies should be provided for inputs to be used for secondary crops to encourage appropriate input use (Bangladesh). ➤ Ensuring timely and adequate availability of inputs, namely seeds, fertilizers and irrigation water, and credit to farmers (Lao People’s Democratic Republic). ➤ Harmonization of the private and public sector is necessary to enhance the capacity of input supply (Myanmar). ➤ It is necessary to make strong logistic support from the public sector and to encourage private sector participation in this business through appropriate incentive schemes and to develop a programme to reform and implement a private/ public partnership for production and distribution of quality farm inputs like fertilizer and pesticides in accordance with the fertilizer law and pesticide law (Myanmar). ➤ Develop a system to encourage all stakeholders engaged in the production of seeds and planting material pertaining to all secondary crops to ensure adequate availability of quality stocks of high-yielding varieties to the farmers at the village level (Sri Lanka). ➤ The efficiency of input supply should be increased to reduce input costs (Viet Nam).
<p>(Fertilizer)</p> <ul style="list-style-type: none"> ➤ Local governments should play significant roles in helping farmer groups produce organic fertilizers, providing farmer groups with shallow tube-well pumps, and identifying and overcoming the causes of fertilizer shortages (Bangladesh).
<p>(Seeds)</p> <ul style="list-style-type: none"> ➤ To resolve problems of quality seed supply, the government should develop and supply foundation seeds for some crops. Private seed farms should multiply these foundation seeds to minimize government interference in the market economy (Lao People’s Democratic Republic). ➤ Due consideration to seed industry development should pay attention to international standards in intellectual property rights or plant variety protection (Myanmar).

Source: Author compiled based on AGRIDIV country study reports in eight countries.

8.8 Regional co-operation

The request for regional co-operation was recommended by several countries. There is tremendous diversity in Asia and the Pacific in terms of size of country, economic policy regime, level of economic development, socio-cultural aspects and natural conditions. Therefore, it can be safely assumed that there is enough possibility to formulate regional collaboration schemes which can produce mutual benefits. Within the participating countries, processing is the field in which co-operation is expected. For example, the cassava industry in Thailand is well advanced in the region including various products from starch to biodegradable plastics. The experience in Thailand can be used as lessons in other cassava producing countries in which the cassava industry is under development (Box 8.8).

Box 8.8 Summary of recommendations (Regional co-operation)

- The success stories in the region need to be properly documented and widely disseminated. Regional co-operation is required to carry forward research and development activities (Bangladesh).
- Collaborative programmes with regional countries should be implemented to enhance the processing and trade of secondary crops (Sri Lanka).

Source: Author compiled based on AGRIDIV country study reports in eight countries.

8.9 Farmer groups

Farmer groups can be effective organizations to solve the problems which small-scale farmers cannot handle individually. Support for farmer groups is recommended in several countries. While farmer groups have several functions, the recommendations focus on their role as a media of contract farming and recipient of developed technologies. Contract farming can avert the associated risks and uncertainty as well as establish strong vertical linkages between production, marketing and processing (Singh, 2005). On the other hand, for resource poor farmers who lack sufficient knowledge about the concept of contract farming, they hesitate to join or face difficulty in complying with the conditions of the contract. Farmer groups can become a party of contract farming which can reduce the risk both for individual farmers and processors or traders. It can be also useful as a recipient of credit and newly developed technologies (Box 8.9).

Box 8.9 Summary of recommendations (Farmer groups)

- Group action may lead to better opportunities to augment farm income (India).
- Collective farmer group participatory programmes should be formulated and implemented for the cultivation of secondary crops within larger land tracks (Sri Lanka).
- Promote group procurement of farm inputs. Besides, arrange for the production of organic fertilizers, compost and bioextracts having a community fertilizer plant to be managed by the farm groups (Thailand).
- Small-scale farmers and particularly the poor need collective actions and adaptive market institutions to establish good links with the market (Viet Nam).

Source: Author compiled based on AGRIDIV country study reports in eight countries.

8.10 Land policy

Some countries recommended a revision of land policies, mainly from the viewpoint of strengthening farmers' motivation to invest in their own land. Legally protected land use rights can be used as collateral for loans, which will reduce credit constraints faced by producers throughout the country (Kyj, 2005). Establishment of proper land use plans to utilize the natural resources effectively, reflecting the comparative advantages of the area, will be also required to maximize the income of rural poor farmers (Box 8.10).

Box 8.10 Summary of recommendations (Land policy)

- More freedom in land use and clear land use rights protected by a legal system are prerequisite for farmers to invest in their land and improve their productivity. The legal transaction of users' rights contributes to a situation in which more efficient farmers are able to produce more. The use of land rights as loan collateral will reduce credit constraints faced by producers throughout the country (Myanmar).
- Uncultivated rice lands under rainfed, major and minor irrigation schemes should be utilized for agricultural diversification (Sri Lanka).

Source: Author compiled based on AGRIDIV country study reports in eight countries.

8.11 Overall conclusion and recommendations

As a conclusion of the project, we would like to propose criteria for designing and implementation policy measures and development actions which will contribute to poverty alleviation through secondary crop based agricultural diversification.

- Technology development for secondary crops should be strengthened. The allocation of R&D resources should be examined based on the effect of the developed technologies on the welfare of rural poor farmers. Development of cost saving technologies should be prioritized.

- Contract farming is an effective measurement to provide mutual benefits both to producers and consumers. A clear and fair standard of contract and monitoring system should be provided by the government.
- Construction of small-scale irrigation, storage facilities and provision of market information should be prioritized in infrastructure development.
- Credit schemes should focus on resource poor farmers. Practical measures such as grouping of credit recipients are necessary to assure repayment.
- Small-scale processing is an effective measure to mitigate rural poverty and should be supported by credit and appropriate technologies. Modern processing has the potential to expand secondary crop demand, which should be monitored carefully to exploit opportunities for poverty alleviation.
- Current price support and import trade policies for major cereals should be carefully examined if these policies exacerbate poor people's welfare.
- Input use for secondary crop production is still low. Therefore, the output expected from increasing input use is relatively higher than major cereals. It is useful to evaluate the benefit of inputs to convince the relevancy of input subsidy schemes.
- There is enough possibility to formulate regional collaboration schemes which can produce mutual benefits based on differences in socio-economic conditions.
- Formulation of farmer groups should be supported to solve problems which small-scale farmers cannot handle individually, especially to promote contract farming and technology dissemination.
- Legal protection of land should be secured to strengthening farmers' motivation to invest in their own land.
- During the in-country seminars conducted January-March 2006 in all participating countries, it was requested for CAPSA to plan follow-up programmes based on the outputs of AGRIDIV. Potential areas include the implications of bioenergy use on poverty alleviation, impact of technology development for secondary crops and training policy planners to formulate pro-poor secondary crop development policies.

References

- Alam, J., 2005, Enhancing Sustainable Development of Diverse Agriculture in Bangladesh. CAPSA Working Paper No. 80, Bogor, Indonesia: UNESCAP-CAPSA.
- Douangsavanh, L. *et al.*, 2006, Enhancing Sustainable Development of Diverse Agriculture in Lao People's Democratic Republic. CAPSA Working Paper No. 89, Bogor, Indonesia: UNESCAP-CAPSA.
- Japan Science and Technology Agency (JST), Food Composition Database, <http://food.tokyo.jst.go.jp/> (7 February 2005)
- Kyi, Aung, 2005. Enhancing Sustainable Development of Diverse Agriculture through CGPRT Crops in Myanmar: Current Status of CGPRT Crop Agriculture and Identification of Its Development Constraints. CAPSA Working Paper No. 85, Bogor, Indonesia: UNESCAP-CAPSA.
- Roonnapai, Nareennat, 2006. Enhancing Sustainable Development of Diverse Agriculture in Thailand. CAPSA Working Paper No. 90, Bogor, Indonesia: UNESCAP CAPSA.
- Siregar, M., Nagai, Naoko and Suryadi, Muhammad, 2006. Secondary Crops Based Farming Systems and their Integration with Processing in Lampung, Indonesia. CAPSA Working Paper No. 98, Bogor, Indonesia: UNESCAP-CAPSA.
- Siregar, M., Suryadi, Muhammad, 2006, Enhancing Sustainable Development of Diversified Agriculture in Indonesia CAPSA Working Paper No. 97, Bogor, Indonesia: UNESCAP-CAPSA.