



**AgEcon** SEARCH  
RESEARCH IN AGRICULTURAL & APPLIED ECONOMICS

*The World's Largest Open Access Agricultural & Applied Economics Digital Library*

**This document is discoverable and free to researchers across the globe due to the work of AgEcon Search.**

**Help ensure our sustainability.**

Give to AgEcon Search

AgEcon Search  
<http://ageconsearch.umn.edu>  
[aesearch@umn.edu](mailto:aesearch@umn.edu)

*Papers downloaded from **AgEcon Search** may be used for non-commercial purposes and personal study only. No other use, including posting to another Internet site, is permitted without permission from the copyright owner (not AgEcon Search), or as allowed under the provisions of Fair Use, U.S. Copyright Act, Title 17 U.S.C.*

**Australian Agricultural and Resource Economics Society's Annual  
Conference**

**2010**

**AGRI-INDUSTRY VALUE CHAIN MODEL: A TOOL FOR INDUSTRY  
BENCHMARKING AND SCENARIO ANALYSIS<sup>1</sup>**

Nazrul Islam<sup>1&2</sup> and Vilaphonh Xayavong<sup>1</sup>

<sup>1</sup>Department of Agriculture and Food, WA

<sup>2</sup>Curtin University of Technology

A contributed paper to the Australian Agricultural & Resource Economics Society's annual  
conference, Adelaide, Feb 10-12, 2010

---

<sup>1</sup> The research is part of the on going 'Agri-food industry value chain analysis' project of DAFWA.  
The authors would like to thank John Connell for his support in undertaking this research.

### **Abstract:**

Agri-industry stakeholders need to respond to the challenge of meeting the demands for higher quality products at competitive prices under increased competition in volatile markets. Development and application of an appropriate computer-based agri-industry value chain model can provide strategic options to deal with these challenges. This paper presents an overview of the theoretical foundation and the structure of an agri-industry value chain model and demonstrates its application as a tool for benchmarking and scenario analysis of the Western Australian Sheep-meat industry.

## 1 Introduction

Farm producers need to respond to the challenge of meeting the demands for higher quality products at competitive prices and increased competition in volatile markets. To become more competitive internationally, agricultural commodities need to develop their value added potential either by quality improvement in primary farm production or by processing and manufacturing before they are exported. Value adding can also replace imports and benefit an economy in many ways.

In Western Australia, statistics reveal that 75 to 95 percent of major agricultural commodities are exported in the identical physical form as they left the farm-gate (Islam, 1997). From the view point of strategic planning and resource allocation of it is important for industry stakeholders to identify and assess the value adding potential of commodities and industries to help achieve increased benefits for WA producers as well as the State economy.

In 1996, the Department of Agriculture and Food Western Australia (DAFWA) undertook a project to develop 'value chain' models to estimate the value added component of major agricultural commodities in Western Australia, to identify commodities and industries with potential for value adding and to determine their relative importance to the State economy. Using data on production, processing and marketing for 1994/95, the value added component and value adding potential of major Western Australian agricultural industries were estimated (Islam, 1997). Since then these models were modified, data updated and applied for a number scenario analyses to find answers to a variety of 'what if' questions. The results of these analyses are also reported (Islam, 1997; Islam and Campbell, 1999; Islam, 2003; Thomas and Islam, 2003 and 2003a; and Radhakrishnan and Islam 2009 are some examples) and used for DAFWA's policy development and resource allocation purposes (Islam, 1998).

In recent years, interests on 'value chain research' by academics, business managers and public policy makers are growing. However, so far the research activities have been limited to qualitative and diagnostic types aimed to analyse supply-chain management problems rather than developing and applying quantitative value chain model that can measure value-added at each stage of the chain as primary products move from 'paddock to plate'.

In this paper, we provide an overview of the conceptual foundation and the structure of an industry value chain model to highlight the usefulness of the model for industry benchmarking and scenario analysis. In Section 2 the model is introduced. The foundation and the structure and components of the model are presented in Sections 3 and 4 respectively. In Section 5, an overview of the development and application of the model as a decision support tool is presented. The summary, conclusion and limitations of the model are presented in the last Section.

We define the term 'agri-industry' as to include both farm and non-farm sectors (such as manufacturing, wholesale, retail and export which are linked to the farm sector in terms of the flow of goods and services). The term 'value added' is defined as the difference between the gross value of production and the value of materials and services used in production. There is a difference between what is referred to as the 'farm value added' (FVA) component and the gross value of agricultural production (GVAP). The former indicates the farming sector's contribution to the State or national income; the latter is the gross income of the farming sector.

## 2 The Value Chain Model

Academics, consultants, and managers have long described the stages in the process of creating value in the physical world as links in a "value chain." The value chain concept is developed from the business management discipline and that was first described and popularized by Porter (1985). Since then the value chain concept is extended to many levels in terms of small to large business entities and also in terms of local to global links (Kaplinsky and Morris, 2000; Chang and Makatsoris 2001, Olla and Patel, 2002; and Gereffi, 2003). The value chain is a model that describes a series of value-adding activities connecting a company's supply side (raw materials, inbound logistics, and production processes) with its demand side (outbound logistics, marketing, and sales). By analyzing the stages of a value chain, managers have been able to redesign their internal and external processes to improve efficiency and effectiveness.

The value chain model treats information as a supporting element in the value-adding process, not as a source of value in itself. Managers often use information that they capture on inventory, production, or logistics to help monitor or control those processes, for instance, but they rarely use information itself to create new value for the customer.

The value chain model we developed is based on the concept of regional economic modeling framework. It is developed in computer spreadsheets as an accounting tool and structured to illustrate the product and financial flows which occur throughout an agri-industry. It provides an overview of the industry and the linkages between the industry and other parts of the economy. The value chain model also specifies product-related information for each sector of the industry including farms, wholesalers, retailers and exporters. The type of product-related information includes:

- the stage of product conversion or transformation;
- the nature and quantity of products (i.e. raw materials) brought forward from previous stages of processing;
- materials and services brought into the chain from outside the industry; and
- the nature and quantity of products which progress to the next stage of processing, or to consumers.

Each physical input or output of an industry is linked directly to price. In this way the model also specifies financial information for each sector in the industry, including:

- the value of products brought forward from previous processing stages;
- the cost of materials and services purchased from outside the chain;
- income accrued at each stage from sales of products;
- transport, storage and handling costs incurred in moving products between processing stages; and
- the difference between total income earned and the total cost of inputs purchased, which in economic terms is value added.

By describing these linkages the model shows the contribution of production, processing and marketing activities to the State, regional or industry economies.

In short, the primary purpose of value chain modelling is to estimate value added components and quantify the relative contribution of an industry to the economy. Models help to identify constraints to, and potential for value adding, from research and development.

Each industry model gives a detailed physical and financial description of its production, processing and marketing sectors (including exports and imports of goods and services). This provides detailed understanding of:

- how one part of the industry interrelates with all other parts of the industry;
- the levels of costs and incomes throughout the industry; and
- the contribution of each part of the industry to total industry output.

### **3 The Foundation of the Model**

In developing an industry value chain model the concept of regional economic modelling is used as its foundation<sup>2</sup>. A regional economic model is commonly developed to address the regional economic development (RED) issues. It is usually aimed to measure and forecast a regional income, output and employment and to study the impact of different policy intervention on a regional economy<sup>3</sup>.

Regional economic modelling recognises the concentration and specialisation of economic activity in different locations and variations in returns to factors of production. These variations imply that different regions will possess distinctive economic characteristics. Regional economics attempts to describe and, if possible, understand the distinctive characteristics of particular regions as these characteristics affect economic performance.

In general the term 'region' is perceived as a physical geographic area. However, the literature on regional economics reveals that a region may be defined as a small rural community and its service area, a large, densely populated area, or at the far extreme, a massive region encompassing several states. Criteria for delineating a region are frequently complex. The region can be defined on the basis of a single criterion resulting either in a physical or geographic region, an economic region, a social and cultural region, or in a region delineated on the basis of jurisdictional boundaries. Alternatively, the region can be defined in terms of any combination of the above criteria.

Most importantly, for a regional delineation to be useful to economists, it must be large enough to be an economic unit - an area with economic relationships and interdependencies between industries - but small enough to show specific development problems.

With the help of Figure 1 simplified characteristics of a regional economic model are illustrated. The box in the center resembles a region. Regions, however delimited, are always interdependent parts of the larger spatial economy in which they are embedded. Regional economic performance usually is critically dependent on a region's ability to provide the goods and services required by other regions. Successful manufacturing regions generally begin by providing specialised goods and commercial services to nearby resource-extraction agricultural areas that are growing in response to demands for primary products in the larger world economy. This type of interdependence is shown by the top and bottom boxes in Figure 1. The top box indicates the flow of resources from outside the boundary of a region and the bottom one indicates the flow of outputs to outside the region. Within a region the economic activities can be classified into different sectors like production, manufacturing, marketing, consumption and public expenditure.

The above discussion suggests that the primary important aspect of regional modelling is to delineate the boundary of a region. In addition, two other fundamental characteristics,

---

<sup>2</sup> Conceptually the present value chain model is similar to the model developed by the Meat Research Corporation and to the concept developed by Porter (1985).

<sup>3</sup> There are hundreds of papers written on different aspects of RED issues (Higgins and Savoie, 1988) and a number of different methods and approaches are developed and used (Anderson, 1988).

notable from the above illustration, are used as the foundation of the industry value chain modelling. One is the flow of inputs/ resources and outputs in and out of a region and the other is the flow of inputs and outputs within a region.

**Figure 1. A Regional Economic Structure**

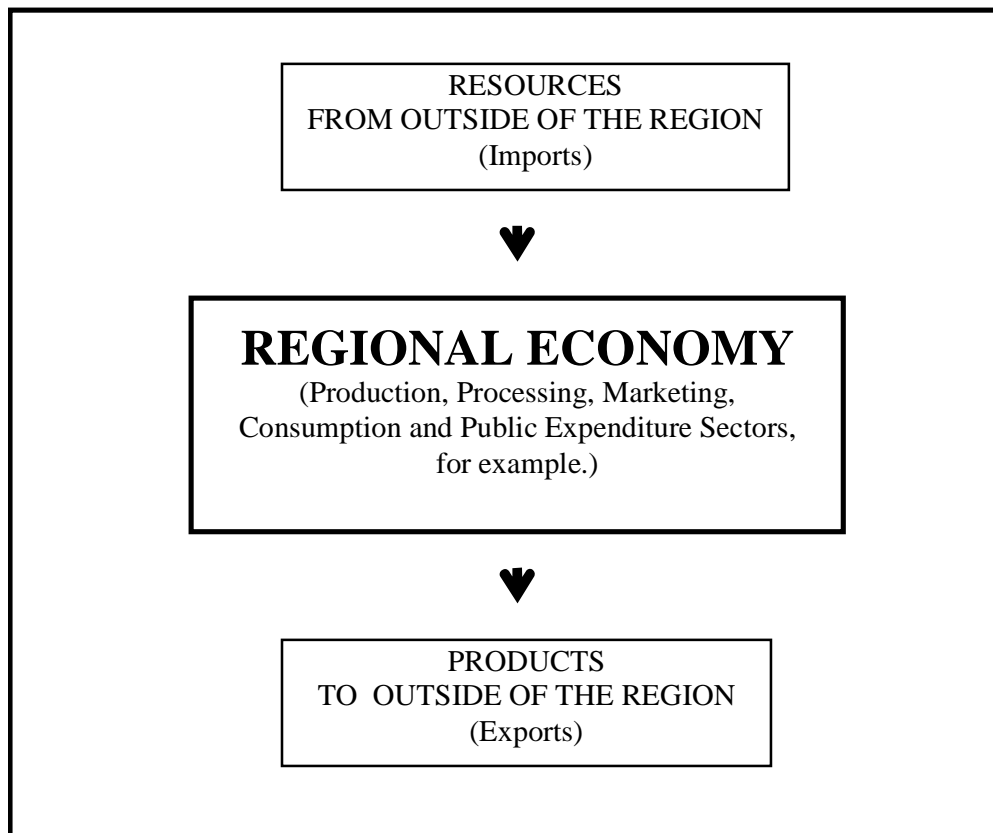

#### **4 The Model Structure and data requirement**

Like a regional economic model an agri-industry value chain model is constructed by delineating the boundary of the industry first and then by identifying the chain of value adding stages of the industry. For example, in building a WA sheep meat industry model it is necessary to define the boundary of the industry by asking questions about what are the sectors to be included, through which the live sheep are slaughtered, processed and marketed as meat and live animal.

The value chain describes the linkages by which farm produce is used as intermediate inputs to produce different products for consumption and exports. The structure is broadly divided into two components, farm and non-farm. The non-farm component is divided into several sectors depending on the number of product transformation stages, analytical requirements and availability of data.

Figure 2 is an example of the flow diagram for WA's sheep meat industry<sup>4</sup>. Each box in the diagram is considered as a value adding sector of the sheep meat industry. The arrows

---

<sup>4</sup> For details of the input-output flow of the industry sectors see the Appendix where the model of WA sheep meat industry sectors are shown as an example.

indicate the flows of commodities and products (meat and meat by-products) among the sectors within the industry.

**Figure 2. The Western Australia Sheep Meat Industry**

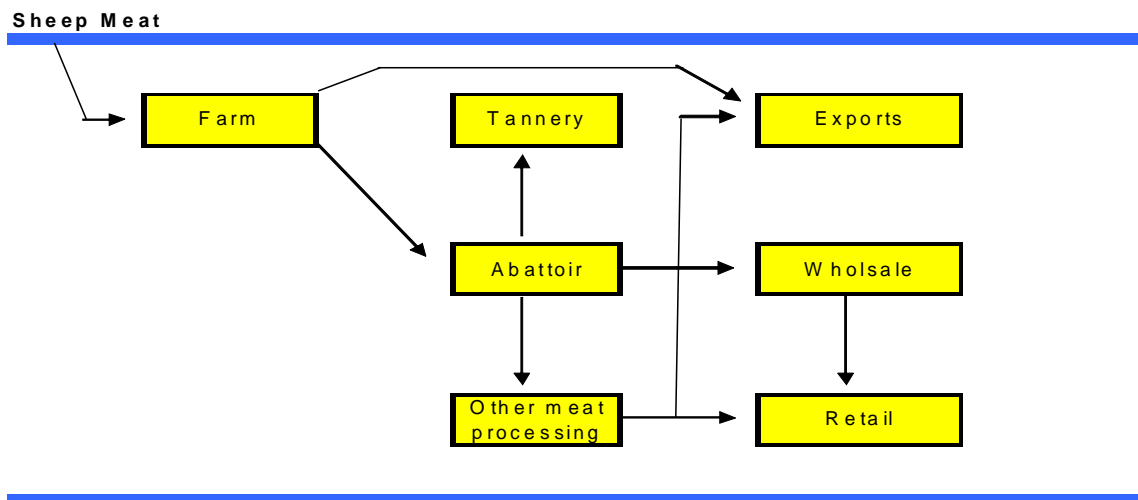

By delineating the boundary of the industry, sectors identified in the flow diagram are classified as 'sectors within-industry'. Other sectors that are not identified but may supply intermediate inputs to or buy final products from 'sectors within-industry' are classified as 'sectors outside-industry'.

To estimate the industry's valued added, it is necessary to estimate the flow values of commodities and products within the 'sectors within-industry', as well as those flow values between the 'sectors within-industry' and the 'sectors outside-industry'. These transactions are production costs that include: (i) input from sectors within-industry (IPWI), (ii) input from sectors outside-industry (IPOI); and revenues that include: (iii) value of outputs sold to sectors within-industry (OPWI) as intermediate goods, and the value of outputs sold to sectors outside industry (OPOI) as final sale.

The estimation is done by creating the transaction tables for each of the identified sectors in a computer spreadsheet. In Figure 3, an overview of a value added spreadsheet structure is presented as such an accounting table. Each of these accounting tables is composed of six sections.

With the exception of the farm sector, Section I of the table includes the types and quantity of intermediate products bought from previous stages of production sectors from within the industry. For the farm sector, Section I includes type and quantity of farm production data.

Section II (inputs from external sources) includes the quantity and price of inputs used from outside the industry to produce or process the quantity of primary or intermediate products in Section I. These include purchased inputs, wages, salaries, services, taxes, rents, and interests.

Section I is linked with Section II by the flow of quantity of primary product produced or the intermediate products purchased in Section I.

Section III includes the turn-off percentage and the proportion of the primary or the intermediate products listed in Section I, which is converted/processed into different types of intermediate and final products.

Section IV includes output conversion factors, which gives technical information about the intermediate inputs listed in Section I to produce products listed in Sections V and VI (for



example, how much raw milk is needed to produce one kilogram of butter and other milk products).

**Figure 3. The Value Added Accounting Structure of a Sector**

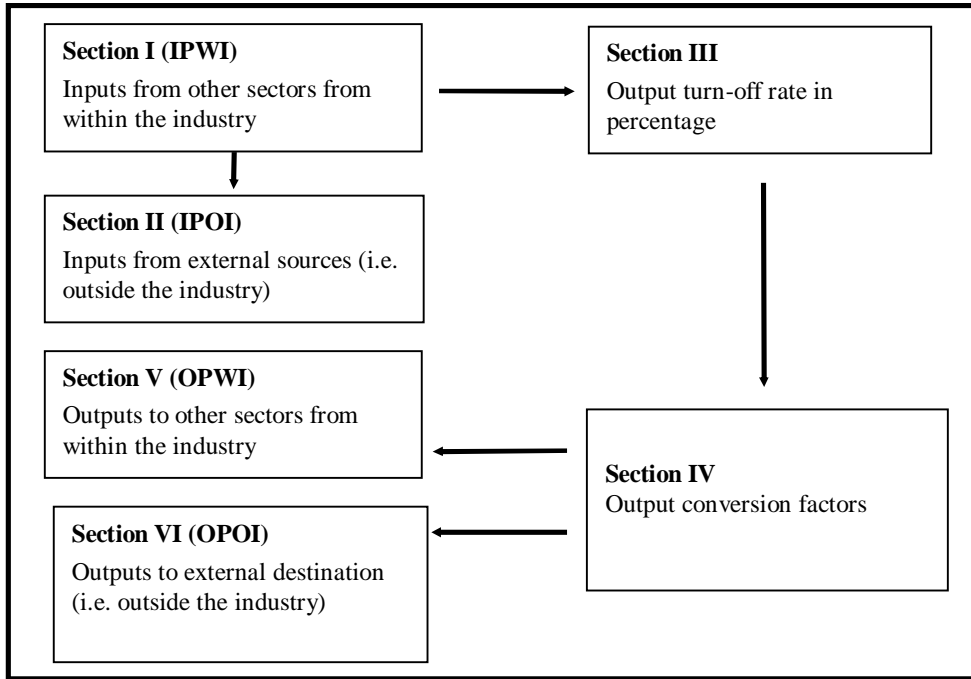

Section V (output to other sectors) includes quantities and prices of intermediate products produced in this sector. For example, the quantities and prices of cheese, butter and flavoured milk produced by the processing sector and will move to the packaging sector, are listed in Section V.

Section VI includes quantities and prices of products, listed in Section I, and go out of the industry as final products. For example, if some cheese and/or butter produced in the milk processing sector and directly sold to consumers, then they are listed in this section. Other products which will not be processed or transformed further are also listed here.

A proportion of the outputs produced in Section V of a sector flow to Section I of subsequent sectors of the industry as input. Therefore, Section V of the previous sector establishes links with Section I of subsequent sectors.

The transaction values are captured by the following equations:

**Total production cost equation for each sector within-industry ( $TC_s$ )**

$$TC_s = \sum_{r=1}^R P_{sr} Q_{sr} + \sum_{x=1}^X C_{sx} \bar{Q}_{sr} + w_s \bar{Q}_{sr} + k_s \bar{Q}_{sr} + v_s \bar{Q}_{sr} \quad (1)$$

Where,  $\bar{Q}_{sr} = \sum_{r=1}^R Q_{sr}$ .

$Q_{sr}$  is the quantity of raw intermediate goods purchased from sectors within industry;

$P_{sr}$  is the purchase prices of  $Q_{sr}$ ;

$C_{sx}$  is the cost of  $x^{\text{th}}$  purchased inputs per unit of  $\bar{Q}_{sr}$  processed;

$w_s$ ,  $k_s$ ,  $v_s$  respectively are wage, rents and interest paid per unit of  $\bar{Q}_{sr}$  processed.

The first argument in the RHS of equation (1) is the cost of raw intermediate goods  $Q_{sr}$  purchased from sectors within-industry (estimated in IPWI table); the second argument is the cost of purchased inputs  $x$  from sectors outside-industry; the third, fourth and fifth arguments are respectively total wage, rent and interests paid in processing total quantity of raw intermediate goods (estimated in IPOI table).

### **Product transformation equation**

In each sector, the raw intermediate goods  $Q_{sr}$ , either individually or in combination processed, are used to produce transformed intermediate  $Q_{si}$  and/or final  $Q_{sf}$ . Therefore, the product transformation equation can be expressed as follows:

$$Q_{si} \text{ \& } Q_{sf} = \phi \sum_{r=1}^R \alpha_{sr} Q_{sr} \quad (2)$$

Where,  $\phi$  is the product transformation factor (e.g. amount of milk needed to produce 1kg butter),  $\alpha_{sr}$  is the proportion of  $Q_{sr}$  and  $\sum_{r=1}^R \alpha_{sr} Q_{sr}$  is therefore the total amount of  $Q_{sr}$  used to produce intermediate  $Q_{si}$  and/or final  $Q_{sf}$ .

### **Total revenue equation for each sector within-industry (TRs)**

$$TR_s = \sum_{i=1}^I P_{si} Q_{si} + \sum_{f=1}^F P_{sf} Q_{sf} \quad (3)$$

Where,  $Q_{si}$  is the sale quantity of intermediate goods;

$Q_{sf}$  is the sale quantity of final goods;

$P_{si}$  is the prices of intermediate goods produced by sectors;

$P_{sf}$  is the prices of final goods produced by sectors.

The first argument in the RHS of equation (3) is the value of the revenue generated from the sale of intermediate goods to other sectors within industry (estimated in OPWI table); the second argument is the revenue received from the sale of final goods to sectors outside-industry (estimated in OPOI table).

Finally, the industry's value added can be derived using equations (1) and (3) as follows:

### **The industry's value added (TVA)**

$$TVA = \sum_{s=1}^S TVA_s \quad (4)$$

Where,  $TVA_s = TR_s - TC_s + w_s \bar{Q}_{sr} + k_s \bar{Q}_{sr} + v_s \bar{Q}_{sr}$

## 4.1 Data requirement and data generation

Data for calculating equations (1) to (3) can be compiled from:

- Agricultural statistics published by the Australian Bureau of Statistics, e.g. ABS cat no 7121.0 and 7125.0;
- Department of Agriculture and Food Western Australia (DAFWA) economic data on commodity gross margins;
- IBISWorld Australia website;
- DAFWA officers and economists; and
- Personal contacts with industry experts.

The value chain model creates in the following resulting tables:

Sector and Sub-sector Table: These spreadsheets are the value added spreadsheets described in Figure 3 above. These tables also include indices that are linked to all types of costs, prices, and product transformation rates that appear in each individual value added spreadsheet. Initial values of these indices are set to 1.0. A number of 'scenario analyses' can be carried out by changing the initial value of these indices.

Input-output Table: This table defines the proportion and quantity of outputs from each sector, sub-sector flow to subsequent sectors. The table is directly linked with each individual value added spreadsheet. Output from each sector's spreadsheet is exported into the matrix which determines the proportion of output flowing to subsequent sectors. Output that flows from any value added spreadsheet to outside the industry and not to subsequent sectors is shown in the input-output table as the final consumption or demand of the industry output.

Value Chain Summary Table: The spreadsheet summarises the results that appear in the individual value added spreadsheets. It also summarises the results of the scenario analysis and enables interpretation of these results. In this spreadsheet value added charts for the industry are displayed for easy and visual understanding of the impact of changes in industry scenarios on the distribution of value added across the industry sectors.

## 5. An overview of the development and application of the model

Xayavong and Islam (2010) provide step by step details of the construction and application of the value chain model using MS Excel VBA programming. In this section an overview of the construction and application of the WA sheep industry value chain model is presented.

There are four steps for constructing an industry value chain model. The Microsoft Excel application of the model is shown in Figure 4, which appears as the main menu.

**Figure 4. The Main Menu of a Value Chain Model**

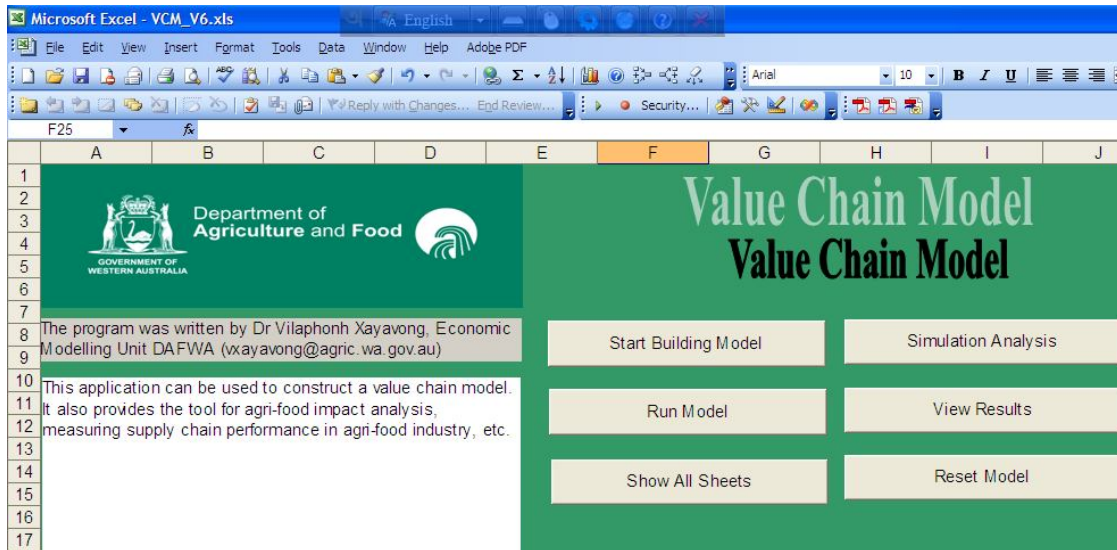

**Step 1: Identify sectors in the model**

The first step is to identify sectors in the model by clicking the “**Start Building Model**” button. This will take to the next section of the spreadsheet shown in Figure 5 where the names of the sectors are to be identified and entered. In this sheet the sector names are classified into three groups: (i) primary farming sector, (ii) wholesale and processing sectors producing intermediate goods, and (iii) retail and export sectors where goods are finally sold out from the industry. The sectors shown in columns A, B and C are respectively the sectors modeled for the WA sheep meat industry.

**Figure 5. Sectors of the WA Sheep Meat Value Chain Model**

	A	B	C
1	Enter	Identify Commodities	Go To Main Menu
2	Farming sector	wholesale/processing sectors	Retail/Export sectors
3	Farm	Abattoir_domestic	Retail_butcher
4		Abattoir_exports	Retail_supermarket
5		OMP	Export_meat
6		Tannery	Export_live_animal
7		Wholesale	
8			

**Step 2: Identify commodities in the model**

Once the entry of the sector names is finished, accounting spreadsheet for each of the identified sectors will be created by clicking the ‘**Enter**’ button in Figure 6 and it will lead to the “**identify commodities sheet**” as seen below in Figure 6.

**Figure 6. Commodities of the WA Sheep Model**

	A	B	C	D	E	F	G	H	I	J	K	L
1	Enter Mapping Model Go To Main Menu			Please enter input and output items for each sector groups: Farming sector (columns in light blue), processing and wholesale (columns in light yellow), and retail and export (columns in pink). Once you finish click enter button.								
2	Commodity input	Input outside industry	Output to sectors within industry	Output to sectors outside industry	Commodity input	Input outside industry	Output to sectors within industry	Output to sectors outside industry	Commodity input	Input outside industry	Output to sectors within industry	Output to sectors outside industry
3	Sheep	Pasture treatment	Wethers+Hogget	Manure	Wethers+Hogget	Wages	Wethers+Hogget	Manure	Wethers+Hogget	Wages		Boneless_prime
4		Reapirs/Fuel/Water	Prime lambs		Prime lambs	Interests	Prime lambs	Rend_by_products	Prime lambs	Interests		Carcases
5		Animal Health (Drenc)	Live_animal_export		Live_animal_export	Rents	Live_animal_export	Pet_food	Live_animal_export	Rents		Offals
6		Requisites (Ear Tags)	Boneless_Meat		Boneless_Meat	Overhead	Boneless_Meat	Emulsified_prodn	Boneless_Meat	Overhead		Live_animal_export
7		Shear/crutch/mark	Carcases		Carcases	Other costs	Carcases	Other_products	Carcases			Wet_blue_hides
8		Feed supplements	Offals		Offals		Offals	Other_retail_meat	Offals			Finished_lather
9		Purchase	Other_by_products		Other_by_products		Other_by_products	Bones_&_fat	Other_by_products			Sheep_skin
10		Transports	Sheep_skin		Sheep_skin		Sheep_skin	Sheep_skin	Sheep_skin			Lamb_skin
11		Wages	Lamb_skin		Lamb_skin		Lamb_skin	Lamb_skin	Lamb_skin			Bones_&_fat
12		Interests	Sausages		Sausages		Sausages		Sausages			Retail_cuts
13		Rents										Sauge_&_meance
14		Overheads										Pet_food
15												

In this sheet, the commodity names for three groups of sectors as identified in Figure 6 above are entered. The commodities of each sector are classified into four categories: (i) commodity input or commodity purchases from sectors within industry, (ii) input purchases from sector outside industries, (iii) output sale to sectors within industry, and (iv) output sale to sectors outside industries or final sale for domestic consumption and export.

It should be noted that the commodity list for each sectors classified as second and third sectors are different from one to another. For example, the commodity input of abattoir sector purchased from farming sectors are Wether & Hogget and Prime Lamb while that of OMP sector purchased from abattoir sector are Boneless Meat, Offal and Other by Products. These commodities lists for the entire second sector need to be regrouping (union) and fill in column E. This is the same when you fill commodity list for the third sector. The commodity list in columns C, E, G and I must be the same to ensure the consistent mapping of commodity flow from one sector to other sectors.

**step 3: Sector-wise data entry**

Once you finish entry commodity names, click **Enter** button. Then commodity list will be filled into four tables of the value chain model and the message box shown below will appear.

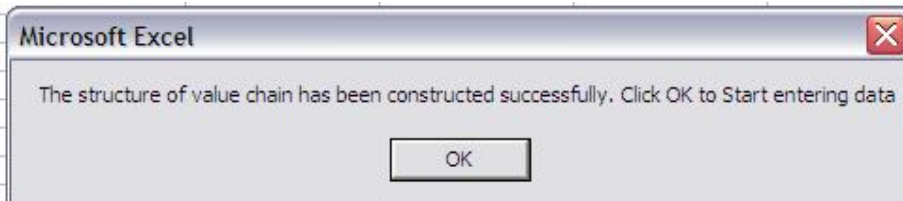

Following the instruction from the message box (click OK button) then it will lead you to the farming sector sheet as seen in Figure 7 below. Note that the range (A1:AC25) are reserved for the model calculation so avoid filling data in this range.



Figure 7. Farming Sector Accounting Table of the Model

	A	B	C	D	E	F	G	H	I	J	K	L	M	N
	Commodity input I	Units	Sim. Coef.	Conv. Coef.	Prices	Quantities	PWVI	Commodity input II	Units	Sim. Coef.	Conv. Coef.	Prices	Quantities	IPOI
2	Sheep				1	2,036,257								
3								Pasture treatment	S/Head	1	1	1.68	2,036,257	3427824.711
4								Respins/Fuel/Water	S/Head	1	1	1.15	2,036,257	2347031.417
5								Animal Health (Drench, Jetting, Vacci	S/Head	1	1	0.63	2,036,257	1267091.177
6								Requisites (Ear Tags, Rings, Wool Pa	S/Head	1	1	0.41	2,036,257	842648.5231
7								Shear/crutch/mark	S/Head	1	1	0.60	2,036,257	0
8								Feed supplements	S/Head	1	1	1.46	2,036,257	2962896.145
9								Purchase	S/Head	1	1	3.01	2,036,257	8139111.441
10								Transports	S/Head	1	1	0.83	2,036,257	1667746.943
11								Wages	S/Head	1	1	1.42	2,036,257	2662075.24
12								Interests	S/Head	1	1	2.37	2,036,257	4834260.633
13								Rents	S/Head	1	1	0.37	2,036,257	746832.8732
14								Overheads	S/Head	1	1	3.18	2,036,257	6442601.397
25						2,036,257	0						16.50	33598241

	O	P	Q	R	S	T	U	V	W	X	Y	Z	AA	AB
	Commodity output III	Units	Sim. Coef.	Conv. Coef.	Prices	Quantities	OPWI	Commodity output IV	Units	Sim. Coef.	Conv. Coef.	Prices	Quantities	OPOI
2	Wethers-hogget	S/Head	1	1	24.2	509064	12341290	Manure					0	0
3	Prime lamba	S/Head	1	1	32.4	450194	14910280							
4	Live animal export	S/Head	1	1	24.2	313584	7602238							
5	Boneless meat					0	0							
6	Carcasses					0	0							
7	Offals					0	0							
8	Other_by_products					0	0							
9	Sheep_skin					0	0							
10	Lamb_skin					0	0							
11	Sausages					0	0							
25					Avg Price	27.169226	1282942	34853922				Avg Price	#DIV/0!	0

	AC	AD	AE	AF	AG	AH	AI	AJ	AK	AL	AM	AN	AO	AP	AQ	AR	AS	AT	AU	AV	AW	AX	AY	
1	Farm	Abattoir	Abattoir_OMP	Tannery	Wholesale	Retail	butk	Retail_sup	Export	Live	Wethers+Prime lamb	Live_anim	Boneless	Carcasses	Offals	Other_by	Sheep_skin	Lamb_skin	Sausages	Manure				
2		66	66								25	22.6	65.4											
25		0	78359.64	432704.6	0	0	0	0	0	0	509064.3	450194.1	313583.6	0	0	0	0	0	0	0	0	0	0	0
26		0	377359.1	82634.93	0	0	0	0	0	0	509064.3	450194.1	313583.6	0	0	0	0	0	0	0	0	0	0	0
27		0	0	0	0	0	0	0	0	0	313583.6	0	0	0	0	0	0	0	0	0	0	0	0	0
28		0	0	0	0	0	0	0	0	0	0	0	0	0	0	0	0	0	0	0	0	0	0	0
29		0	0	0	0	0	0	0	0	0	0	0	0	0	0	0	0	0	0	0	0	0	0	0
30		0	0	0	0	0	0	0	0	0	0	0	0	0	0	0	0	0	0	0	0	0	0	0
31		0	0	0	0	0	0	0	0	0	0	0	0	0	0	0	0	0	0	0	0	0	0	0
32		0	0	0	0	0	0	0	0	0	0	0	0	0	0	0	0	0	0	0	0	0	0	0
33		0	0	0	0	0	0	0	0	0	0	0	0	0	0	0	0	0	0	0	0	0	0	0
34		0	0	0	0	0	0	0	0	0	0	0	0	0	0	0	0	0	0	0	0	0	0	0
35		0	1851104	10490101	0	0	0	0	0	0	0	0	0	0	0	0	0	0	0	0	0	0	0	0
36		0	12226436	2683852	0	0	0	0	0	0	0	0	0	0	0	0	0	0	0	0	0	0	0	0
37		0	0	0	0	0	0	0	0	0	0	0	0	0	0	0	0	0	0	0	0	0	0	0
38		0	0	0	0	0	0	0	0	0	0	0	0	0	0	0	0	0	0	0	0	0	0	0
39		0	0	0	0	0	0	0	0	0	0	0	0	0	0	0	0	0	0	0	0	0	0	0
40		0	0	0	0	0	0	0	0	0	0	0	0	0	0	0	0	0	0	0	0	0	0	0

The above three figures are the accounting table of farming sector. The top figure shows the input or cost accounting tables (IPWI under dark A-G columns and IOPI under H-N columns). The middle figure shows the output or revenue accounting tables (OPWI under O-U columns and OPOI under V-AB columns). The bottom figure shows the output transformation or turn-off rate of farming commodities (i) under AC-AL columns are the proportions (in per cent) of farming commodities sold to other sectors, and (ii) under AM-AW column are the transformation rate in percent of farming commodities. You need to fill the quantity, prices, conversion factors, simulation coefficient, the proportion of commodity flows and the product transformation rates in the column provided.

**Step 4 : run the model**

Once the data entry for all the sectors is complete, go to the main menu and click the **Run Model** button. Once you click **Run Model** button it will take a while before you get the sheet that show the summary result of value chain model. As shown in Figure 8.

**Figure 8. Summary Results Sheet of the Model**

	A	B	C	D	E	F	G	H	I	J	K	L
		Farm	Abattoir d	Abattoir e	OMP	Tannery	Wholesale	Retail butcl	Retail supe	Export mea	Export live	Sum
1												
2	Input from sectors within industry (\$)	0	14,077,631	13,173,953	3,650,762	4,846,292	12,539,715	25,141,721	10,366,737	19,464,458	7,602,238	110,852,507
3	Input from sectors outside industry (\$)	33,698,241	6,193,261	9,606,549	9,364,493	7,308,208	3,270,669	29,329,178	11,566,011	2,840,027	8,018,959	121,003,498
4	<b>Total Input (\$)</b>	<b>33,698,241</b>	<b>20,270,892</b>	<b>22,880,502</b>	<b>13,016,256</b>	<b>12,154,499</b>	<b>15,810,285</b>	<b>54,470,899</b>	<b>21,920,748</b>	<b>22,313,486</b>	<b>15,621,197</b>	<b>231,856,005</b>
5	Output to sectors within industry (\$)	34,853,822	23,166,980	25,672,101	0	12,600,358	14,559,246	0	0	0	0	110,852,507
6	Output to sectors outside industry (\$)	0	314,135	0	13,534,341	0	2,316,218	66,370,404	29,865,968	27,825,422	21,974,950	162,201,439
7	<b>Total Output (\$)</b>	<b>34,853,822</b>	<b>23,481,116</b>	<b>25,672,101</b>	<b>13,534,341</b>	<b>12,600,358</b>	<b>16,875,464</b>	<b>66,370,404</b>	<b>29,865,968</b>	<b>27,825,422</b>	<b>21,974,950</b>	<b>273,053,946</b>
8	Profit (\$)	1,266,581	3,210,224	2,991,598	619,086	445,869	1,065,179	11,899,505	7,946,220	5,511,937	6,353,752	41,197,941
9	Wages (\$)	2,882,075	4,505,428	6,634,994	2,006,677	2,907,775	377,373	13,654,896	4,678,974	194,872	470,375	38,313,440
10	Interests (\$)	4,834,281	28,736	48,117	430,002	164,774	53,910	1,634,741	750,401	159,795	301,040	8,405,798
11	Rents (\$)	746,833	57,471	96,234	358,335	329,548	35,940	3,269,482	1,500,803	0	0	6,394,646
12	<b>Value Added (\$)</b>	<b>9,718,770</b>	<b>7,801,859</b>	<b>9,770,943</b>	<b>3,314,100</b>	<b>3,847,956</b>	<b>1,532,403</b>	<b>30,458,624</b>	<b>14,875,399</b>	<b>5,866,603</b>	<b>7,125,168</b>	<b>94,311,825</b>
13	<b>Value Added in %</b>	<b>0</b>	<b>8.3%</b>	<b>10.4%</b>	<b>3.5%</b>	<b>4.1%</b>	<b>1.8%</b>	<b>32.3%</b>	<b>15.8%</b>	<b>6.2%</b>	<b>7.8%</b>	<b>100.0%</b>
14	%Profit	0	13.7%	11.7%	3.8%	3.5%	6.3%	17.9%	26.6%	19.8%	26.9%	
15	%Wages	0	19.2%	25.8%	14.8%	23.1%	2.2%	20.6%	15.7%	0.7%	2.1%	
16	%Interests	0	0.1%	0.2%	3.2%	1.3%	0.3%	2.5%	2.5%	0.6%	1.4%	
17	%Rents	0	0.2%	0.4%	2.6%	2.6%	0.2%	4.9%	5.0%	0.0%	0.0%	
18												
19												
20												
21												
22												
23												
24												
25												
26												
27												
28												

The model also provides the input-output table. To see this table, click IO1 tab and scroll down to row 210 (check balance). Zero entry in this row indicates the input-output table is balanced.



## 5.2. Simulation Analysis

For simulation of the model for scenario analysis go to the main menu again as in Figure 9 (which is the same as Figure 5 above).

**Figure 9. The Main Menu of a Value Chain Model**

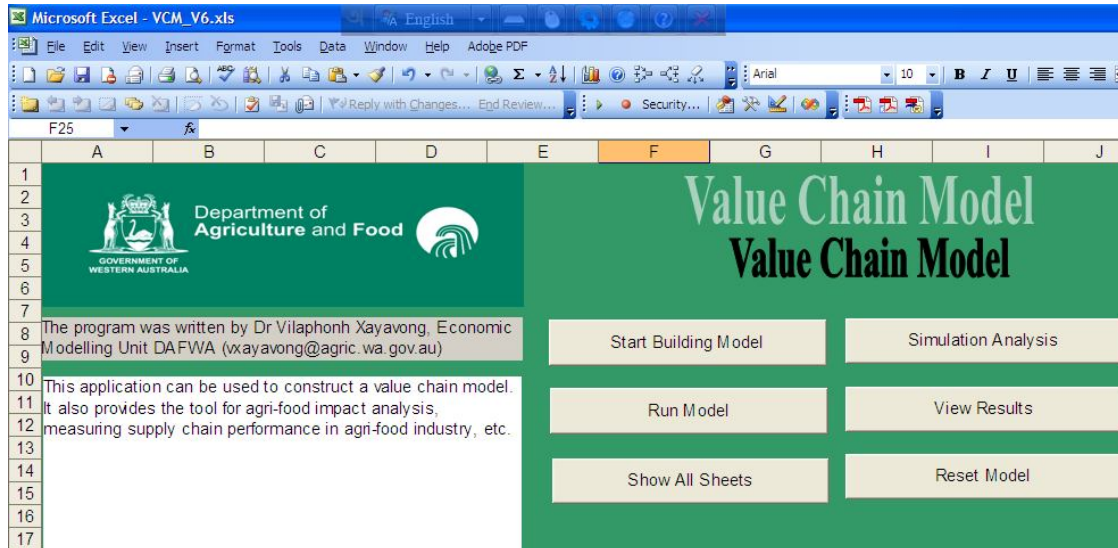

Click Simulation Analysis button to start this task. Once you click it, the simulation analysis window will appear as shown in Figure 10:

**Figure 10. The Simulation window of the Model**

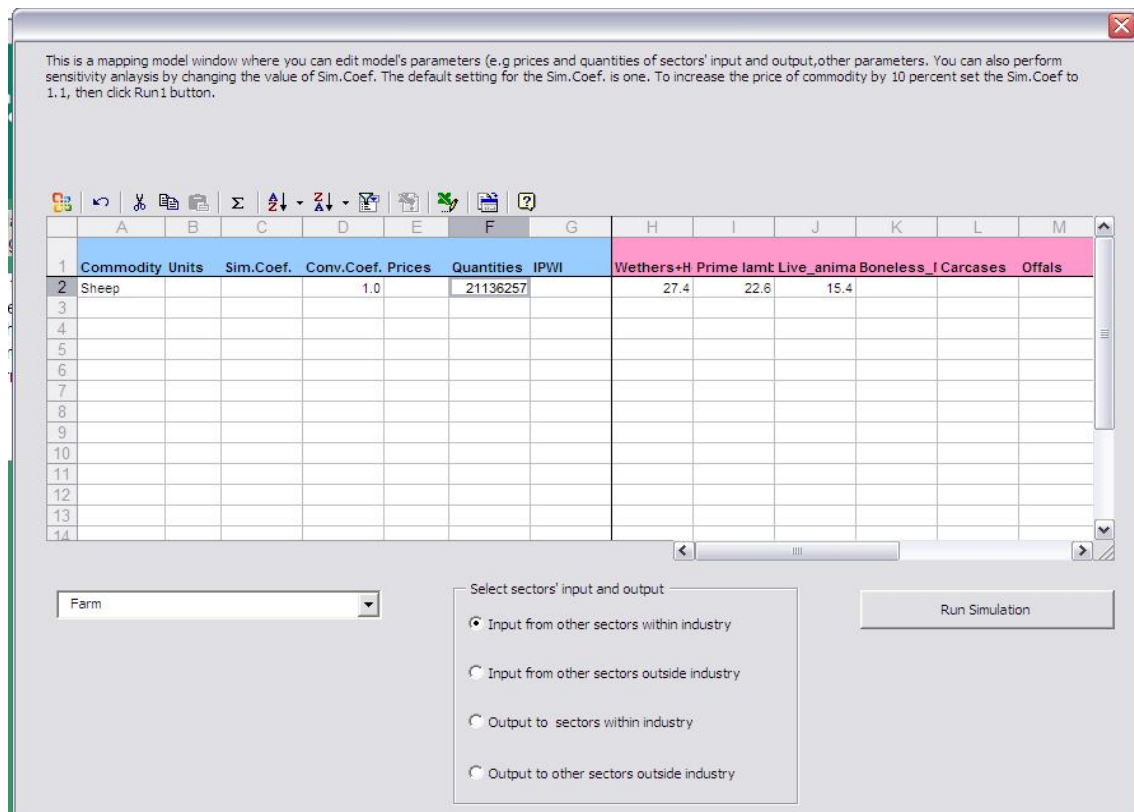

Use drop down box on the left of the window to select sector in the model (it shows 'Farm' for example), and select 'sectors' input-output options in the center to navigate through four accounting tables of value chain model. In Figure 10, the IPWI of farm sector was selected. Here you can change number of sheep stock (in F2) and the farm's turn-off rate (in H2 to J2). Click Run Simulation to see the result. That is you will see the summary result of value chain and input output table as explained above. Figure 11 shows the simulation result of changing the 'Conv. Coef.' (in D2) from the original 1 to .8 and reducing the live animal export per cent from 15.4 (see J2) to 10.

**Figure 11. The Main Menu of a Value Chain Model**

	A	B	C	D	E	F	G	H	I	J	K	L	M
1	% Change	Farm	Abattoir_domest	Abattoir_exports	OMP	Tannery	Wholesale	Retail_butcher	Retail_supermarket	Export_meat	Export_live_animal	Sum	
2	Input from sectors within industry (%)	#DIV/0!	-92.4%	-92.8%	-92.8%	-92.7%	-92.6%	-92.6%	-92.5%	-92.7%	-95.0%	-92.8%	
3	Input from sectors outside industry (%)	-80.4%	-92.4%	-92.9%	-92.8%	-92.7%	-92.6%	-92.6%	-92.5%	-92.8%	-95.0%	-92.2%	
4	Total Input (%)	-90.4%	-92.4%	-92.9%	-92.8%	-92.7%	-92.6%	-92.6%	-92.5%	-92.7%	-96.0%	-92.5%	
5	Output to sectors within industry (%)	-83.1%	-92.4%	-92.9%	#DIV/0!	-92.7%	-92.7%	#DIV/0!	#DIV/0!	-92.7%	-95.0%	-92.5%	
6	Output to sectors outside industry (%)	#DIV/0!	-92.5%	#DIV/0!	-92.8%	#DIV/0!	-92.8%	-92.8%	-92.8%	-92.7%	-95.0%	-92.9%	
7	Total Output (%)	-83.1%	-92.4%	-92.8%	-92.8%	-92.7%	-92.6%	-92.6%	-92.5%	-92.7%	-96.0%	-92.9%	
8	Profit (%)	-131.0%	-92.4%	-92.7%	-92.2%	-92.7%	-92.6%	-92.6%	-92.5%	-92.7%	-95.0%	-95.1%	
9	Wages (%)	-90.4%	-92.4%	-92.9%	-92.8%	-92.7%	-92.6%	-92.6%	-92.5%	-92.8%	-95.0%	-92.5%	
10	Interests (%)	-90.4%	-92.4%	-92.9%	-92.8%	-92.7%	-92.6%	-92.6%	-92.5%	-92.8%	-95.0%	-91.4%	
11	Rents (%)	-90.4%	-92.4%	-92.9%	-92.8%	-92.7%	-92.6%	-92.6%	-92.5%	#DIV/0!	#DIV/0!	-92.3%	
12	Value Added (%)												
13	Simulation Result												
14	Input from sectors within industry (\$)	0	11,282,105	10,539,162	2,920,610	3,877,033	10,031,772	20,113,377	8,284,589	15,571,587	3,949,215	86,549,430	
15	Input from sectors outside industry (\$)	33,598,241	4,954,609	7,605,239	7,491,595	5,848,566	2,616,456	23,463,343	9,252,009	2,279,222	4,165,893	101,272,972	
16	Total Input (\$)	33,598,241	16,216,714	18,144,402	10,412,205	9,723,600	12,648,228	43,576,720	17,536,598	17,850,788	8,114,908	187,822,402	
17	Output to sectors within industry (\$)	25,750,482	18,533,534	20,537,680	0	10,060,287	11,647,397	0	0	0	0	86,549,430	
18	Output to sectors outside industry (\$)	0	251,308	0	10,827,473	0	1,852,974	53,096,323	23,892,774	22,280,338	11,415,558	123,598,760	
19	Total Output (\$)	25,750,482	18,784,893	20,537,680	10,827,473	10,060,287	13,500,371	53,096,323	23,892,774	22,280,338	11,415,558	210,146,179	
20	Profit (\$)	-7,847,759	2,568,179	2,393,279	415,289	356,687	852,143	9,519,604	6,366,176	4,409,549	3,300,651	22,323,777	
21	Wages (\$)	2,882,075	3,604,342	5,307,995	1,605,342	2,328,220	301,699	10,923,917	3,743,179	155,898	244,351	31,095,217	
22	Interests (\$)	4,834,281	22,988	38,494	344,002	131,819	43,128	1,307,793	600,321	127,836	156,385	7,607,047	
23	Rents (\$)	748,833	45,977	76,987	286,658	263,636	28,752	2,615,596	1,200,642	0	0	5,285,084	
24	Value Added (\$)	615,430	6,241,486	7,616,756	2,651,280	3,078,364	1,225,923	24,366,899	11,900,319	4,693,203	3,701,306	66,291,125	
25	Baseline												
26	Input from sectors within industry (\$)	0	147,969,850	147,198,178	41,040,105	52,840,643	136,476,488	272,546,458	109,742,166	214,016,530	78,910,892	1,200,741,309	
27	Input from sectors outside industry (\$)	348,748,241	65,324,413	106,628,511	103,917,239	79,683,689	35,560,783	317,488,319	122,872,604	31,607,321	83,236,440	1,295,087,569	
28	Total Input (\$)	348,748,241	213,294,263	253,826,689	144,957,344	132,524,331	172,037,270	590,034,777	232,614,769	245,623,851	162,147,332	2,495,808,867	
29	Output to sectors within industry (\$)	374,078,920	243,900,706	286,746,482	0	137,365,871	156,629,530	0	0	0	0	1,200,741,309	
30	Output to sectors outside industry (\$)	0	3,248,724	0	150,303,670	0	24,958,245	718,710,250	316,973,593	308,339,726	228,099,000	1,748,731,154	
31	Total Output (\$)	374,078,920	247,249,429	286,746,482	150,303,670	137,365,871	183,585,776	718,710,250	316,973,593	308,339,726	228,099,000	2,949,472,462	
32	Profit (\$)	25,330,680	33,955,186	32,919,794	5,346,327	4,861,339	11,548,505	128,875,474	84,368,789	60,715,875	65,951,668	453,663,595	
33	Wages (\$)	29,915,813	47,521,716	74,420,224	22,267,980	31,704,386	4,103,167	147,814,234	49,711,817	2,181,923	4,882,475	414,503,735	
34	Interests (\$)	50,179,618	303,093	539,696	4,771,710	1,796,582	586,167	17,696,070	7,972,650	1,772,777	3,124,784	86,735,146	
35	Rents (\$)	7,752,092	606,185	1,079,392	3,976,425	3,593,164	390,778	35,392,140	15,945,300	0	0	68,735,478	
36	Value Added (\$)	113,178,202	82,386,190	108,959,106	36,362,441	41,965,470	16,628,617	329,577,918	157,989,535	64,650,576	73,958,927	1,025,645,951	

## 6 Summary and Conclusions

The value chain model is a computerised accounting tool. It is developed in computer spreadsheets and structured to illustrate the product and financial flows which occur throughout the industry. It provides an overview of the industry and the linkages between the industry and other parts of the economy through the flow of relevant inputs and outputs. The value chain model also specifies product-related information for each sector of the industry including farms, wholesalers, and exporters.

The regional economic modelling concept is used as its foundation. There are two fundamental regional economic characteristics - one is the linkage of a region to other regions in terms of the inflow and outflow of goods and services, and the other is the linkage of different sectors in terms of the flow of goods and services within the region.

The value chain spreadsheet model is a simple, transparent and powerful analytical tool which can provide key information to support a number of management and strategic planning decisions, including budget allocation. The analysis of value added results can reveal the relative importance and potential of an industry in an economy.

The contribution of agriculture to an economy is often under-valued because value adding beyond the farm-gate is not readily available and taken into account. The value chain model can capture the final value of agricultural commodities by the time they are processed and reach retail shelves in an economy or the rest of the world.

Each commodity value chain model can be utilised in two ways. Firstly, because the value chain model provides an overview of all activities and products within the industry, it can be used as a physical and financial description of the industry. Each model is descriptive and can serve as a reference source. It highlights the basic structure and characteristics of the commodities under the industry. Secondly, the model can be used as a research and analytical tool and can complement other models for input-output and demand and supply analyses. It can analyse the impacts on industry changes due to events external to the industry, such as inputs and product prices, technologies, tariffs and exchange rates.

The value chain model however has some limitations. A few of these limitations are listed below.

- The model does not show the effect of changing production levels on prices.
- It does not indicate the effects of price and cost changes on production.
- The development and data requirement of this model in some cases may require involvement of a number of agencies and authorities at different levels.

## References

- Anderson, F.J. (1988). *Regional Economic Analysis: A Canadian Perspective*. Harcourt Brace, Javanovich, Toronto.
- Chang, Y. and H. Makatsoris (2001). 'Supply Chain Modelling Using Simulation' *International Journal of Simulation*, Vol 2(1):
- Gereffi, G (2003). 'The Global Apparel Value Chain: What Prospect for Upgrading by Developing Countries', Strategic Research and Economic Branch, UNIDO, Vienna.
- Higgins, B. and Savoie, D.J. (eds.) (1988). *Regional Development: Essays in Honour of Francois Perroux*, Unwin Hyman, Boston.
- Islam N. (1995). 'Capturing the Benefits of Value Adding from Research and Development: A Review of Methods'. Program Evaluation Unit, Policy Analysis and Industry Development Division, Department of Agriculture Western Australia, July (Mimeo).
- \_\_\_\_\_ (1995a). 'Regional Economic Framework and a Value Chain Study'. A paper presented to the Branch meeting of the MERA, Agriculture WA. Kalbarri 16-19 October.
- \_\_\_\_\_ (1997). *Agriculture and the Western Australian Economy: Value Added Contribution of Agricultural Commodities*. ISBN 0-7307-0033-X, Office of Policy and Planning, Agriculture WA. December.
- \_\_\_\_\_ (1997a). *The value of Western Australian Agricultural Commodities at the Point of Final Sale*. Office of Policy and Planning, Agriculture WA. December.
- \_\_\_\_\_ (1998). 'The Western Australian Agri- industry Value Chain Model: An Overview', a discussion paper presented to the Semester I Seminar Series of the Faculty of Agriculture and Resource Economics, University of Western Australia, 13 March.
- \_\_\_\_\_ (1999). 'Relevance of Agri-Industry Value added in Allocating R&D Funds for Agriculture Western Australia, . Program Evaluation Unit, Policy Analysis and Industry Development Division, Department of Agriculture Western Australia, April (Mimeo).
- \_\_\_\_\_ and C. Campbell (1999). 'Value Added Contribution of the Western Australian Cattle Industry', a report prepared for the Floriculture Project, Agriculture Western Australia, South Perth
- \_\_\_\_\_ (2003). "A Practical Guide to Value Chain Modelling" *Economic Series 2003.1* Economic Services, Department of Agriculture Western Australia, South Perth, January.
- Kaplinsky, R. and M. Morris (2000). "A Handbook for Value Chain Research", prepared for the IDRC  
[http://www.catie.ac.cr/econegociosagricolas/bancomedios/documentos%20pdf/rde\\_cv%20kaplinsky.pdf](http://www.catie.ac.cr/econegociosagricolas/bancomedios/documentos%20pdf/rde_cv%20kaplinsky.pdf)
- MRC (1993). *The Value Chain for Meat and Livestock Products: Research and Development Investment Study*. Project No. M246, Meat Research Corporation, Sydney.
- Olla, P. and N.V. Patel (2002). 'A Value Chain Model for Mobile Data Service Provider', *Telecommunication in Policy*, Vol 26 (9-10), Oct-Nov.
- Porter, M. (1985). *Competitive Advantage: Creating and Sustaining Superior Performance*. The Free Press, Sydney.

- Radhakrishnan, M and N. Islam (2009). "Measuring the benefits from R&D investment beyond the farm gate: the case of the WA wine industry", a contributed paper to the Australian Agricultural & Resource Economics Society's annual conference, Feb 11-13, Cairns, QLD  
<http://ageconsearch.umn.edu/bitstream/48169/2/Radhakrishnan.pdf>
- Thomas, G. and N. Islam (2003). '*Supply Chain Competitiveness of the WA Wine Industry: Final Report*', Project Number RT 01/23-2, Department of Agriculture Western Australia, South Perth, February.
- \_\_\_\_\_. and N. Islam (2003). "*Supply Chain Competitiveness of the WA Wine Industry: Summary*", Project Number RT 01/23-2, Department of Agriculture Western Australia, South Perth,
- Xayavong, V. and N. Islam (2010). "Constructing Value Chain Model with the Application of Microsoft Excel Programming", Department of Agriculture and Food, WA (forthcoming).
- Xayavong, V. and N. Islam (2009). "Constructing Agri-food Industry Input-Output Data: A Value Chain Modelling Approach", a contributed paper to the Australian Agricultural & Resource Economics Society's annual conference, Feb 11-13, 2009, Cairns, QLD.  
Xayavong, V. and N. Islam  
<http://ageconsearch.umn.edu/bitstream/47950/2/Xayavong.pdf>

## Appendix

### Details of commodity Input-Output flow of WA Sheep Meat value chain model.

This appendix provides a detail of commodity flows from farm sector to non-farm sectors such as manufacture (abattoir, meat processing, and tannery), wholesale, retail and export. Commodities of each sector are classified into four groups and listed in the bigger boxes: commodity input purchased from sectors within industry (IPWI), commodity input purchased from sectors outside industry (IPOI), commodity output sold to sectors within industry (OPWI) and commodity output sold to sectors outside industry (OPOI). Sector names are in the smaller boxes.

As mentioned earlier, sectors are classified into three groups: (1) farming sectors, (2) wholesale and processing sectors where intermediate goods are produced, and (3) retail and export sectors where goods are finally sold out from the industry. The following charts presents the mapping commodity flow for each sector in three groups. While the ways of various commodities for each sector are present in the same manner, there are a few exceptions as noted in the following:

The top left commodity box of farm sector includes farm's commodities, while that of second and third sectors includes the intermediate products bought from previous stages of production sectors from within the industry.

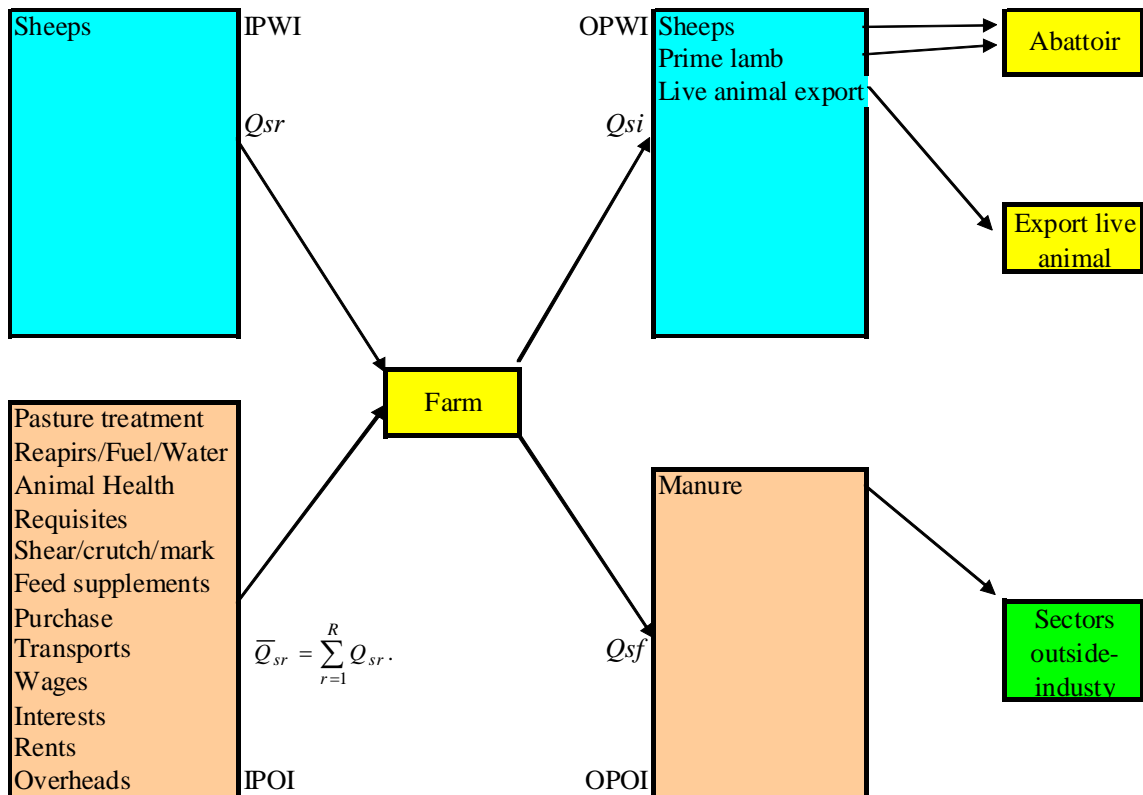

The bottom left commodity box includes commodity inputs purchased from outside the industry to produce or process the primary or intermediate products. It also includes wages, salaries, services, taxes, rents, and interests.

The top right commodity box includes the sector's intermediate products, while the bottom right one include the sector's products going out of the industry as final products. Sectors in the second group may only have either OPWI commodity box or both OPWI and OPOI commodity boxes, while sectors in the third group have only the OPOI commodity box.

