



**AgEcon** SEARCH  
RESEARCH IN AGRICULTURAL & APPLIED ECONOMICS

*The World's Largest Open Access Agricultural & Applied Economics Digital Library*

**This document is discoverable and free to researchers across the globe due to the work of AgEcon Search.**

**Help ensure our sustainability.**

Give to AgEcon Search

AgEcon Search

<http://ageconsearch.umn.edu>

[aesearch@umn.edu](mailto:aesearch@umn.edu)

*Papers downloaded from **AgEcon Search** may be used for non-commercial purposes and personal study only. No other use, including posting to another Internet site, is permitted without permission from the copyright owner (not AgEcon Search), or as allowed under the provisions of Fair Use, U.S. Copyright Act, Title 17 U.S.C.*

***Brownbag Seminar***  
**Southcom in Haiti: Security,  
Provisions, and Logistical Support for  
the Humanitarian Assistance Effort**

**March 22, 2010, USDA Economists Group**

Mark Thompson

Trade and Biofuels Analysis Division



**USDA Foreign Agricultural Service**

**Office of Global Analysis**

# Outline

- 1. What happened?**
- 2. What is Southcom?**
- 3. How did it work in Haiti?**
- 4. What was my role?**
- 5. How does it work?**
- 6. What's next for Haiti?**



**USDA Foreign Agricultural Service**

**Office of Global Analysis**

# Background on Haiti Earthquake

- o Earthquake of magnitude 7.0 hit just 10 miles WSW of Port-Au-Prince, at 4:53 PM Tuesday January 12. It's Haiti's first earthquake in nearly 50 years.
- o **Fatalities total over 200,000; over 300,000 injured.**
- o The entire workings of the Haitian government and MINUSTAH (the UN security and development presence of nearly 10,000) were seriously damaged and barely functioning.



**USDA Foreign Agricultural Service**

**Office of Global Analysis**



Courtesy WFP



**USDA Foreign Agricultural Service**  
**Office of Global Analysis**



# EARTHQUAKE-AFFECTED AREAS AND POPULATION MOVEMENT IN HAITI

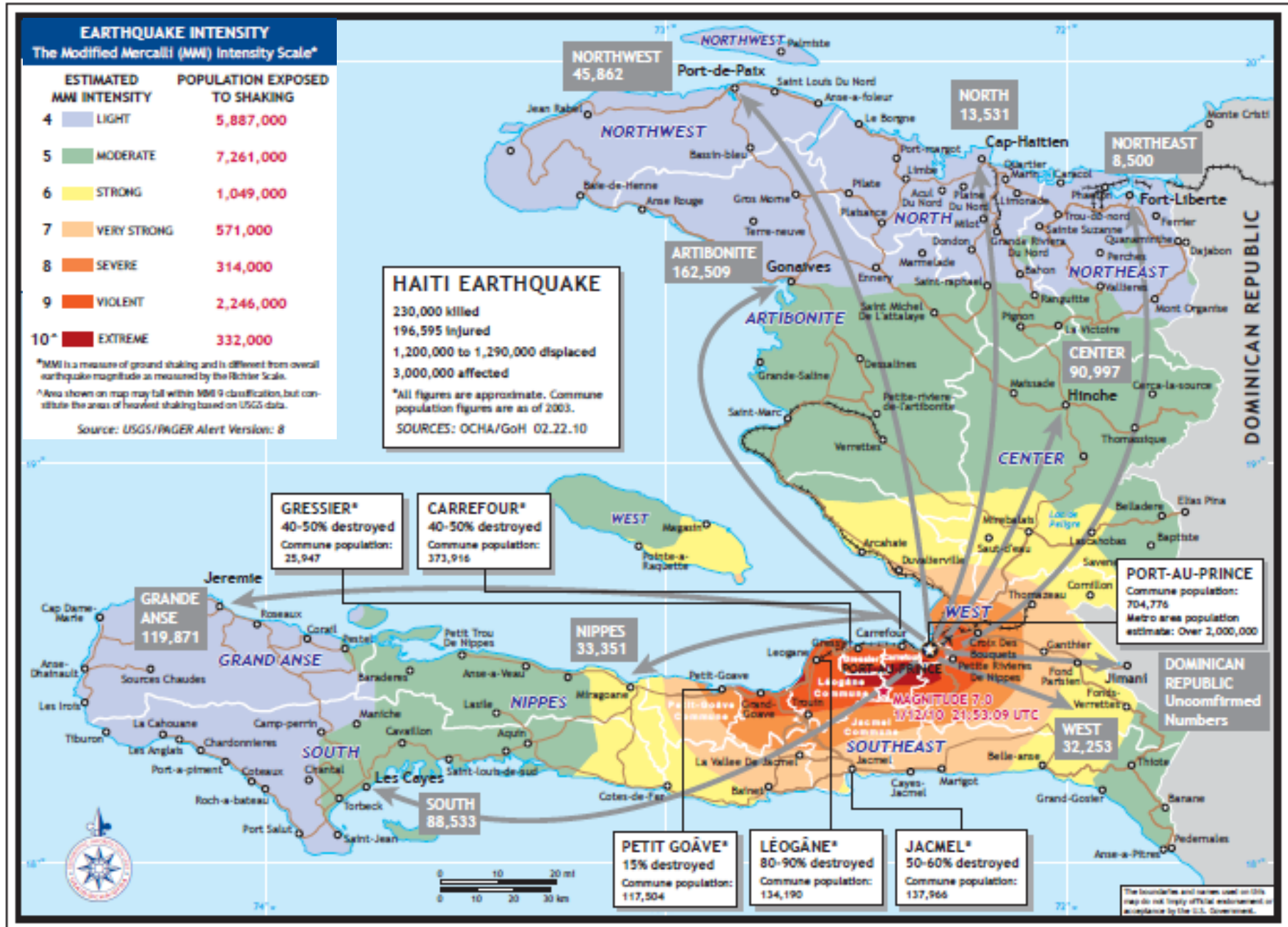

# Damage to all transport systems



Courtesy North Shore Journal



**USDA Foreign Agricultural Service**

**Office of Global Analysis**



# Southcom coverage: Caribbean + everything south of Mexico



**USDA Foreign Agricultural Service**  
**Office of Global Analysis**



# Initial Response: Rescue and Relief

USAID

Southcom

State

Commerce

USDA

HHS



**USDA Foreign Agricultural Service**

**Office of Global Analysis**

# USDA Response: Plan for Reconstruction

?? ??



USDA Foreign Agricultural Service

Office of Global Analysis

# Cooperation Needed

**USAID**

**USDA**

**State**

**Commerce**

**Southcom**

**HHS**

**WFP**

**UNOCHA**

**FAO**

**MINUSTAH**

**NGOs**

**GoH**

**IICA**

**Other  
countries**



**USDA Foreign Agricultural Service**

**Office of Global Analysis**

# Southcom: Resources + Experience

- 1) Get transport working
  - a. Airport
  - b. Marine port
- 2) Get SAR, medical teams on the ground
- 3) Relief supplies
  - a. Food
  - b. Water
  - c. Medical
- 4) Security – internal
- 5) Security – external. Invasion of boat people?
- 6) Coordination between all the players.



**USDA Foreign Agricultural Service**

**Office of Global Analysis**



# USSOUTHCOM ORG CHART

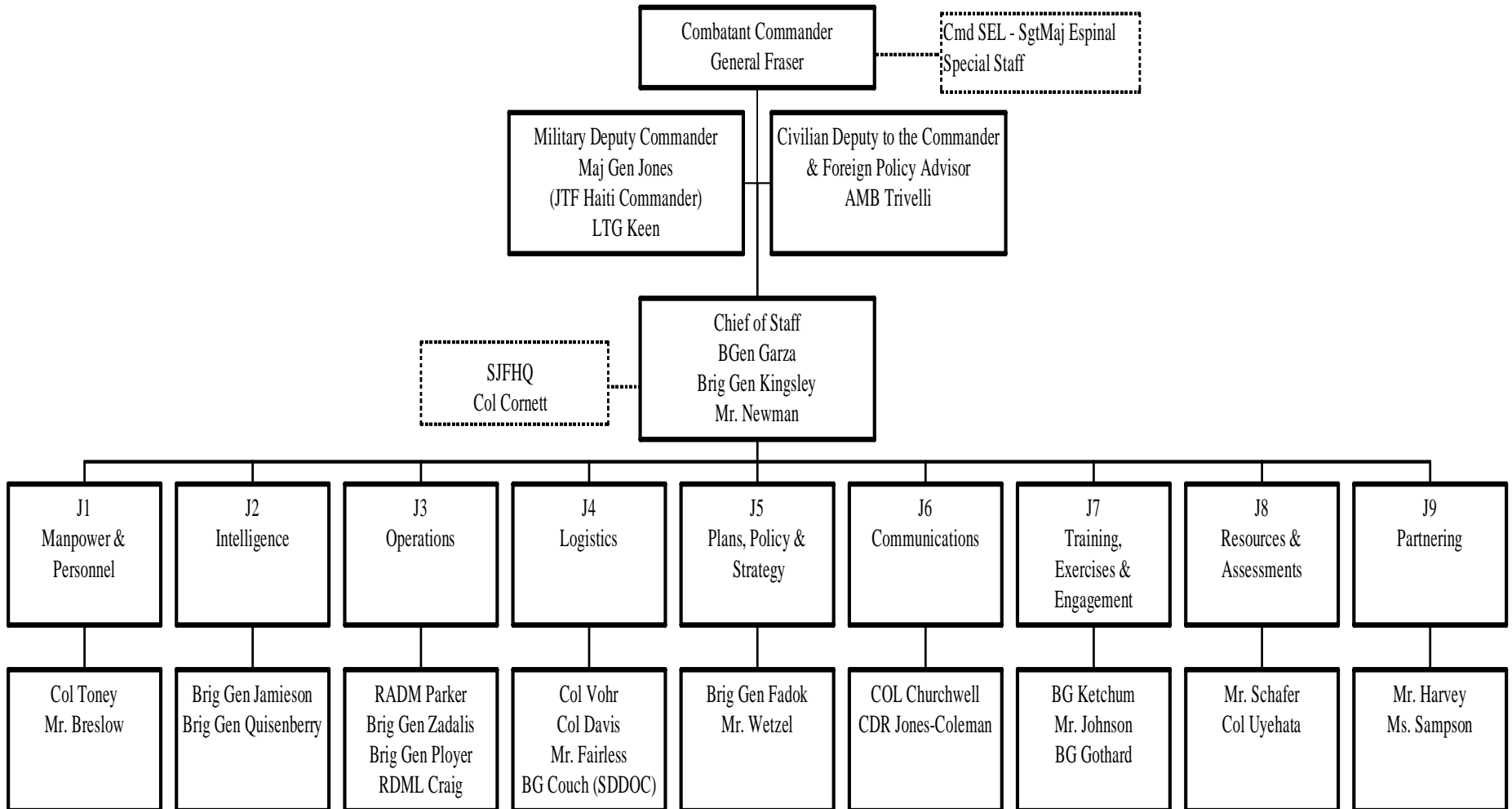

As of: 10 Feb 10

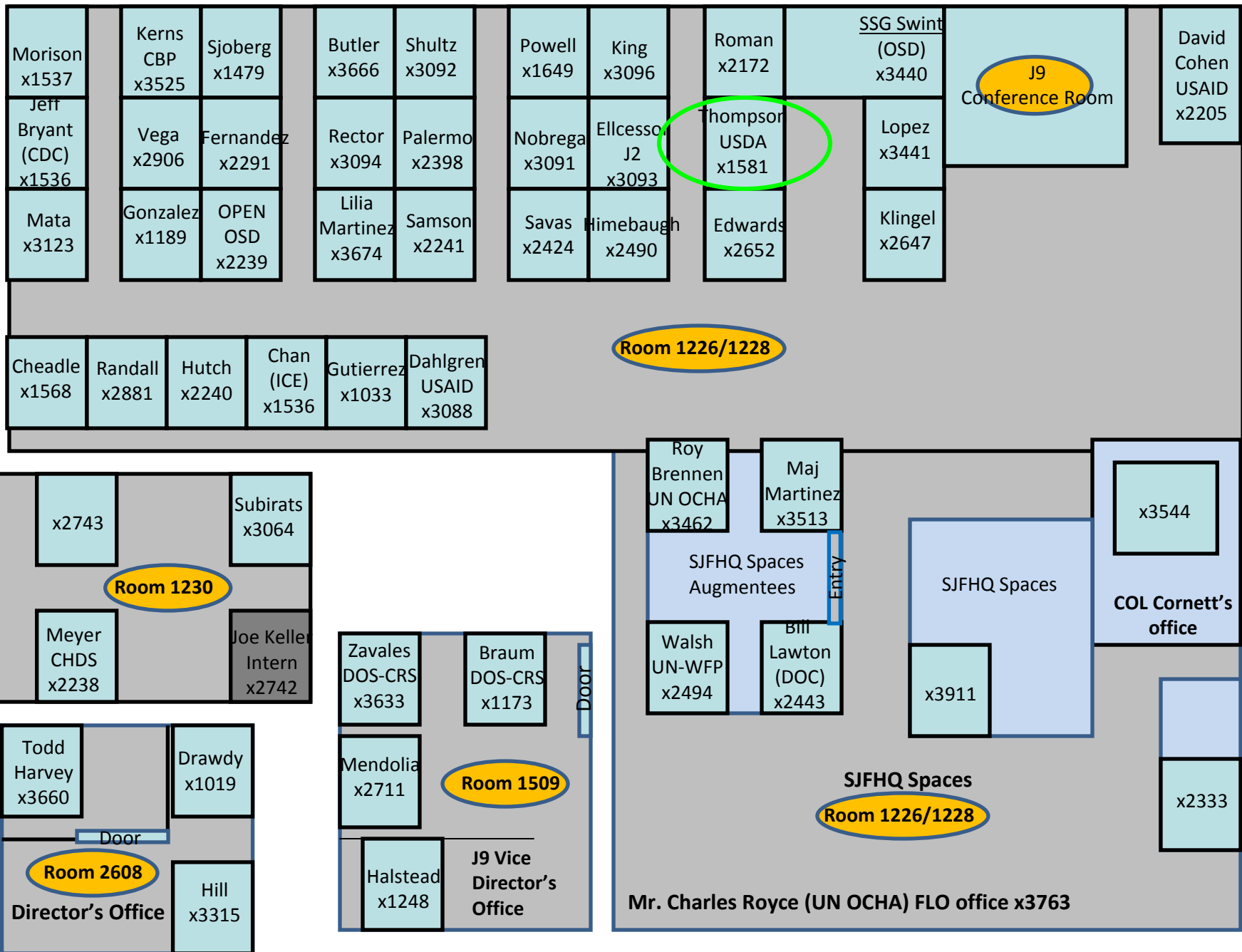

# MUB: Mission Update Brief

1. General Fraser led the meeting
2. JTF Haiti DVC
3. All geographic units reported
4. All directorates reported



**USDA Foreign Agricultural Service**

**Office of Global Analysis**

UNCLASSIFIED



# Task Organization

In support of the Government of Haiti ICW the United Nations

## Operation UNIFIED RESPONSE

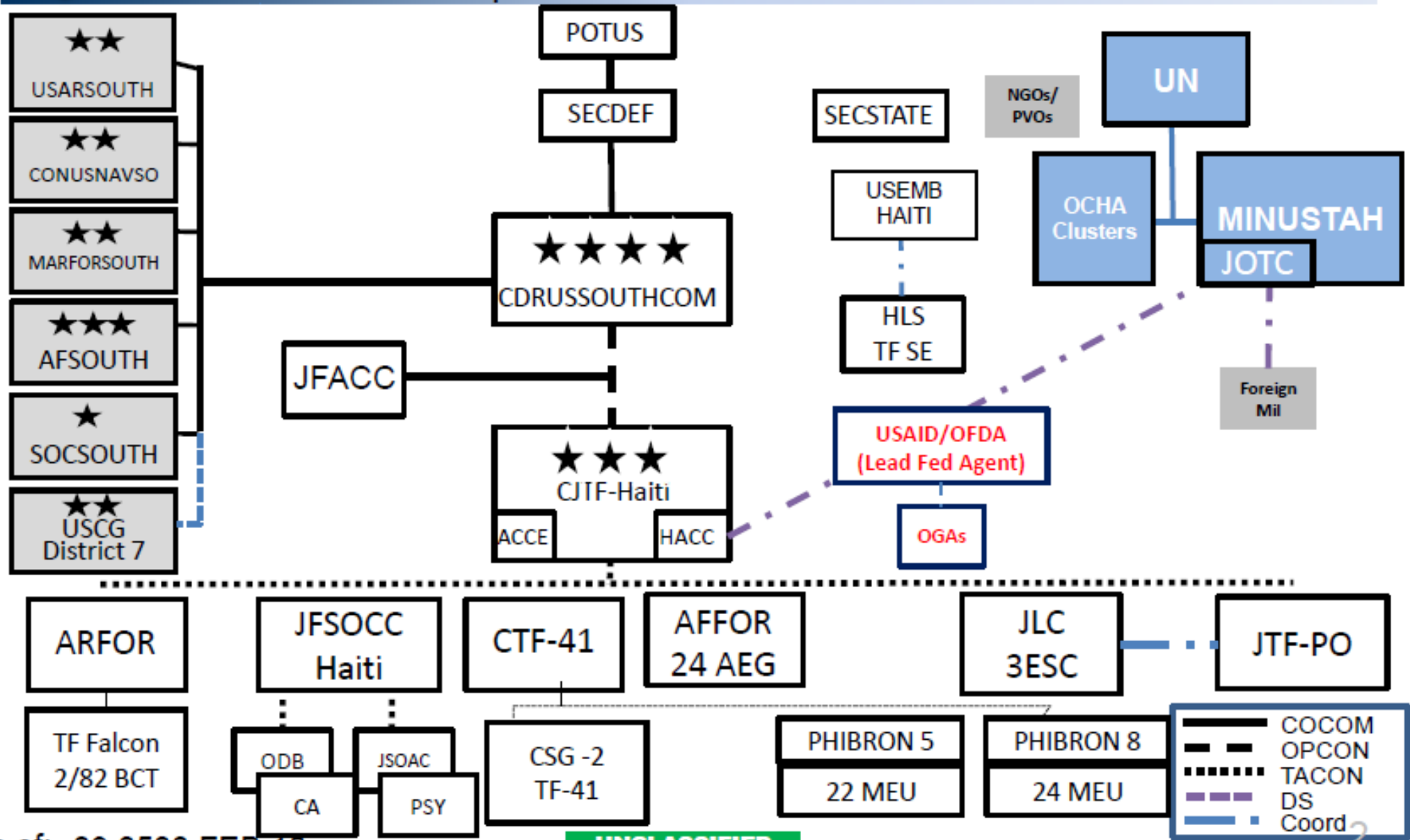

As of: 09 0500 FEB 10

UNCLASSIFIED





# Weather Operational Impacts



## Operation UNIFIED RESPONSE

- Partly cloudy skies marginal impact ISR

	09-Feb		10-Feb		11-Feb							
	12Z	18Z	00Z	06Z	12Z	18Z	00Z	06Z	12Z	18Z	00Z	
<b>A/SPODS</b>												
PaP	C	C	C	C	C	C	C	C	C	C	C	C
San Isidro	C/P	C/P	C	C	C	C	C	C	C	C	C	C
Barahona	C/P	C/P	C	C	C	C	C	C	C	C	C	C
Jacmel	C/P	C/P	C	C	C	C	C	C	C	C	C	C
<b>Transit Lanes</b>												
[Green]												
<b>Logistic Hubs</b>												
Norfolk	[Green]	C/V	C/P	C/P	C/P	[Green]	[Green]	[Green]	[Green]	[Green]	[Green]	[Green]
Charleston	C/P	C/P	C/P	C/P	[Green]	[Green]	[Green]	[Green]	[Green]	[Green]	[Green]	[Green]
Jacksonville	C/V	C/P	C/P	[Green]	[Green]	[Green]	[Green]	[Green]	[Green]	[Green]	[Green]	[Green]
Homestead	[Green]	[Green]	C	C/P	C/P	C	[Green]	[Green]	[Green]	[Green]	[Green]	[Green]
<b>ISR</b>												
PaP	C	C	C	C	C	C	C	C	C	C	C	C
<b>C CLOUDS/CLG</b> <b>P PRECIP</b> <b>T TRAFFICABILITY</b> <b>TS THUNDERSTORMS</b> <b>W HIGH WIND</b> <b>H HEAT INDEX</b> <b>V VISIBILITY</b> <b>S SIGNIFICANT WAVE HEIGHTS</b>												

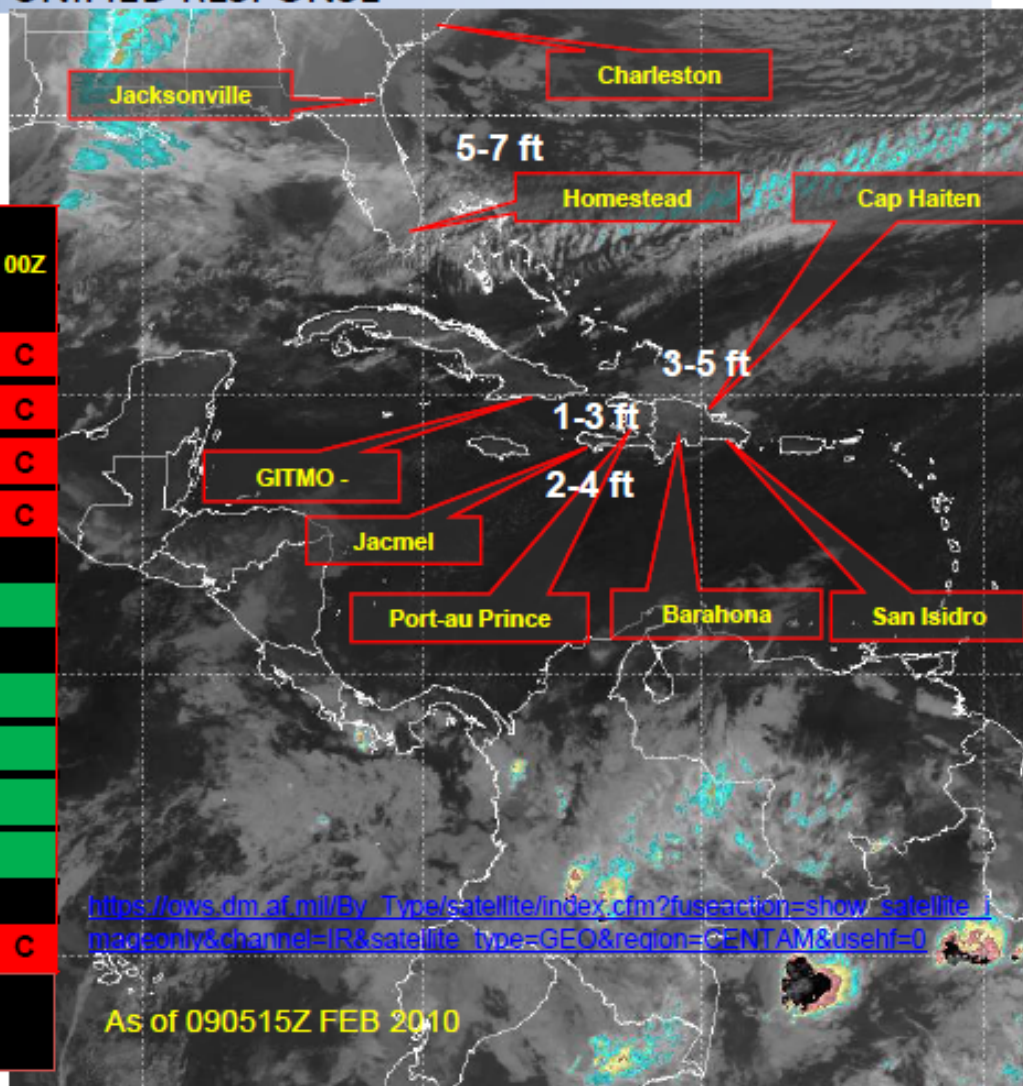



# Situation Update



## Operation UNIFIED RESPONSE

**(U)** The overall situation will remain calm and continues to improve in all areas. Shelter and medicine remain top priorities for Haitians and relief agencies. Criminal elements will continue to re-group and compete for territory; violent crime will remain in traditional high crime areas of Cite Soleil, Martissant, La Saline, and Bel Air. Food prices will likely continue to increase where supply is low, and decrease where supplies are high. No mass migration from Haiti is expected in the near term.

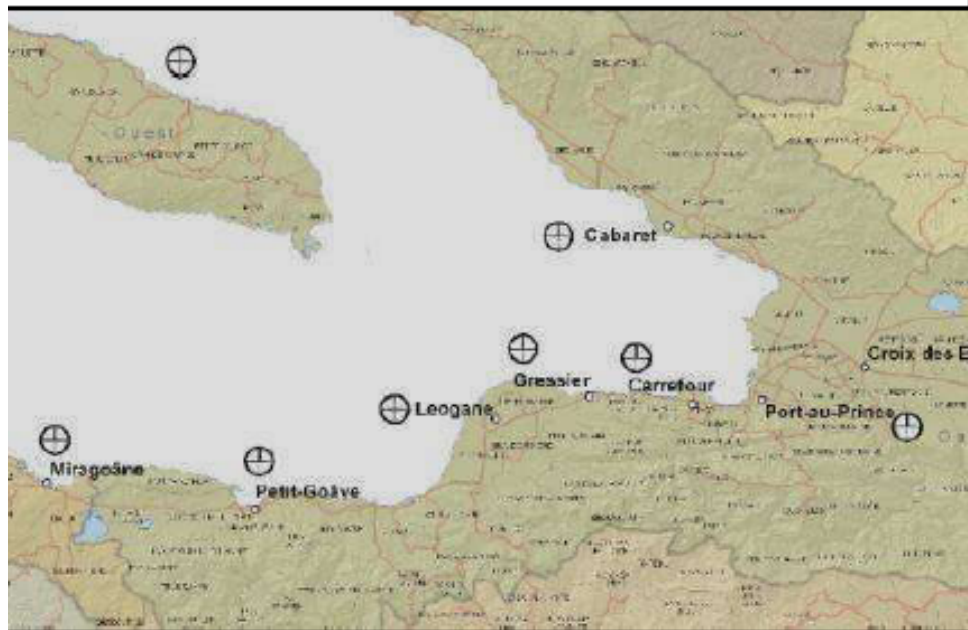

### **(U)** Security/Threat Activity

NC

- No security incidents at DPs
- Inter-gang violence reported in Martissant; Initial reports indicate up to 5 gang members killed
- Armed escorts of US convoys between PaP and the Dominican Republic will reportedly cease today; convoys and shuttle service will continue with local guards patrolling routes as necessary

### **(U)** Infrastructure

NC

- IFRC reporting indicates an estimated 80,000 people in Leogane and 30,000 in Jacmel require shelter

### **(U)** Medical

NC

- Doctors expressed concern over the potential for an outbreak of tuberculosis.
- Haiti has the most reported cases of tuberculosis out of any country in the western hemisphere.

### **(U)** Governance

NC

- Food prices, including wheat and bread, have increased in some areas outside of Port au Prince; prices continue to decline in Port au Prince
- Cuba and Venezuela supplying generators to Saint Marc

### **(U)** Migration/Internal Relocation

NC

- Sailboat carrying 62 Haitians was intercepted off the coast of the Bahamas
- No indications of mass migration





UNCLASSIFIED

# 22d MEU



## PAST 24 HOURS

- 22d/24th MEU Commanders turnover brief in Carrefour conducted
- 22d MEU CO conducted visual RECCE of ISB security mission
- 22d MEU CO attended MINUSTAH augmentation meeting
- Completed RIP with 24 MEU in Carrefour, WFP DPs, ISB, and IAF
- Tank Plt/India Co turned over IAF security to 209th MP Co
- Support FRAGO 065 Task 4 (Recovery of Operation Superbowl equipment)
- WFP Push (Day 9)

## NEXT 24 HOURS

- Continue support to WFP DPs 1 and 16
- Continue security mission at ISB
- Continue force sustainment operations in AO
- Aviation Op Pause / Safety Stand-down
- WFP Surge (Day 10)

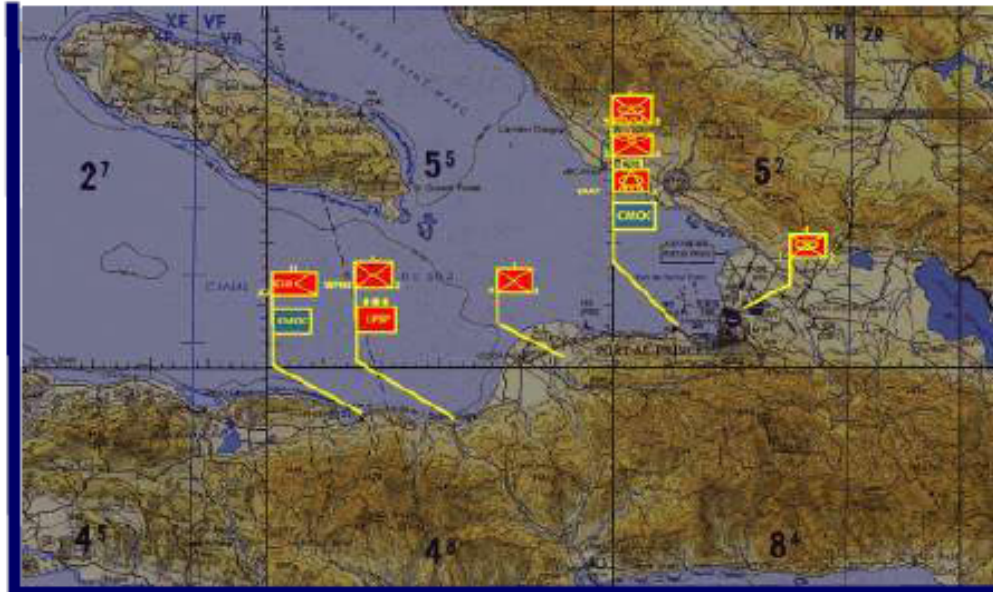

## OPERATIONAL METRICS

- Today:
  - 8,740 1L bottle equiv of water
  - 6,330 pounds of rations
- To Date:
  - TWPS- Produced 92,779
  - 484,035 1 L bottle equiv of water
  - 1,210,195 pounds of rations
  - 6,987 pounds of supplies
  - 18,924 pounds of medical supplies
  - 50 gallons of fuel
  - 61 patients seen

UNCLASSIFIED

# Day-to-Day Work

1. Information flow between USDA and Southcom/J9  
Interagency effort:
  - i. High level (personal). Get the MUB slide updated.
  - ii. Sitreps, classified and unclassified
  - iii. Intel
2. Economic analysis of situation and agriculture
3. Mango exporters
4. In-kind donation
5. Briefing on FAS functions



**USDA Foreign Agricultural Service**  
**Office of Global Analysis**



# Status of Ports in Haiti

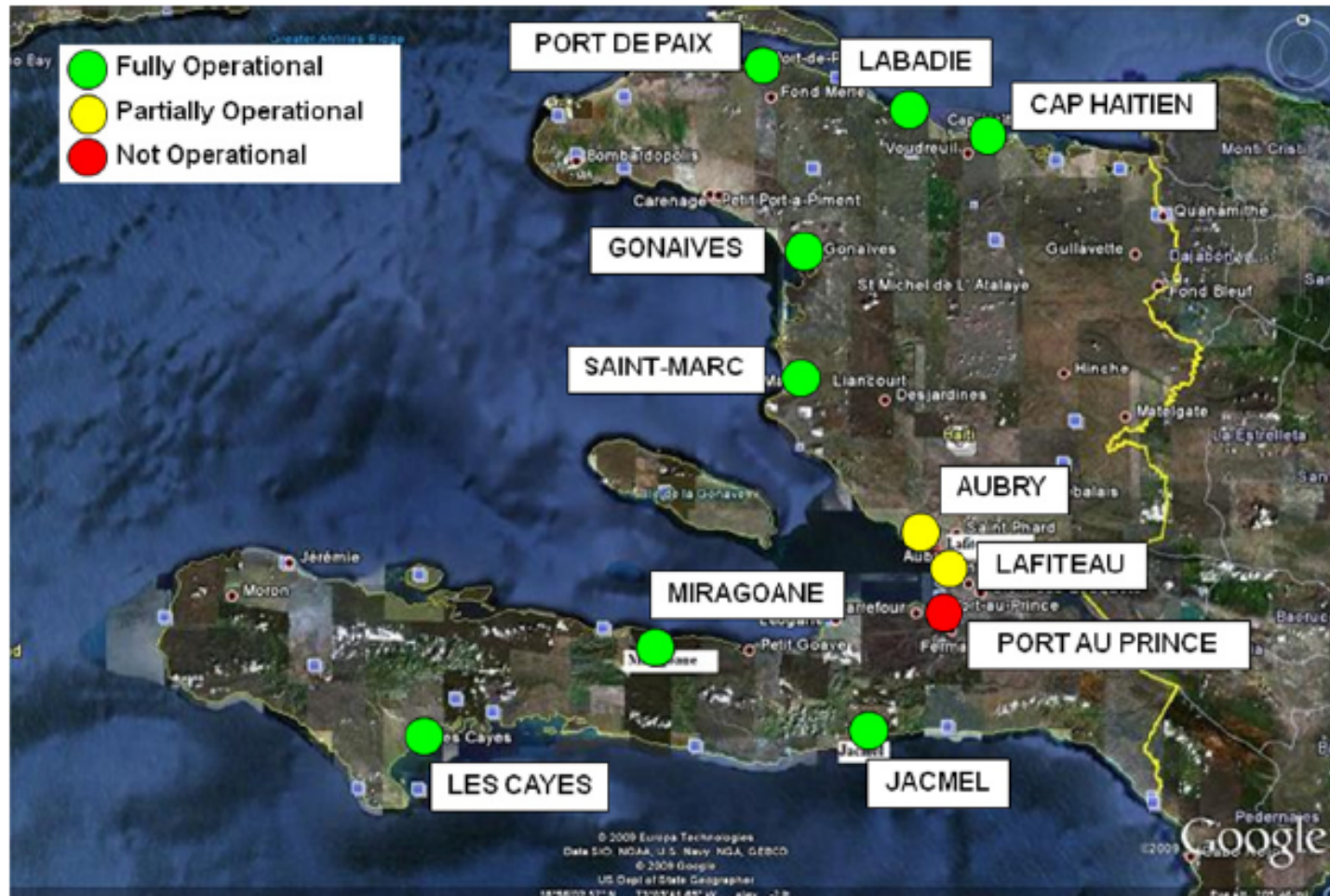

Source: US Department of Homeland Security; Commander, Atlantic Area



**USDA Foreign Agricultural Service**  
**Office of Global Analysis**



# FACILITY STATUS MATRIX



UNCLAS/FOUO 0400Z 09 FEB 10

Facility Name	Facility Type	Current Status	Future Plans / Notes
PaP APN South Pier	Gen Cargo	<u>Partially Available</u>	South Pier is currently working within the confines of USN's structural parameters--24/7 ops ongoing. The first phase of the Crowley barge plan began 2/6 when the first deck barge (400' x 100') arrived for positioning alongside the north face of the south pier. Phase two will begin when the second (400' x 100') barge arrives on 2/18 to join the first to complete an 800' x 100' temporary dock w/a crawler crane. RESOLVE MARINE continued salvage work alongside the North Pier (forward) in preps for crane removal.
PaP APN North Pier	Container- Break-Bulk RO/RO	<u>Not Available</u>	Collapsed.
Texaco & National (THOR) Bulk Oil / LPG Facility	Bulk Oil / LPG / Diesel / Av Gas	<u>Partially Available</u>	Continues 24-hr transfer offload operations. Thor is fully functional for transfer operations. Facility requires permanent repairs in order to be fully available.
Varreux Bulk Oil / LPG Facility	Bulk Oil / LPG / Diesel / Av Gas	<u>Partially Available</u>	Accepting dry cargo. Repairs initiated. T/V IVER PROGRESS completed first successful transfer since earthquake. Varreux is fully functional for transfer operations. Facility requires permanent repairs in order to be fully available.
Cimenterie Nationale (Cement Facility)	Cement	<u>Fully Available</u>	Planning on 24 hour operations--managed via the Govt. of Mexico.
Les Moulins D'Haiti (Grain Facility)	Grain Processing	<u>Not Available</u>	Severe damage to grain processing equipment.
Le Ciment de Sud (LCS South) Cement Facility	Cement	<u>Not Available</u>	Facility was heavily damaged and reported not active prior to earthquake.
Gold Beach	LCU Transfers	<u>Fully Available</u>	Receiving heavy equipment.
Military Temp Landing Area (Red 1, 2 & 3)	LCU Transfers	<u>Fully Available</u>	Resumed 24/7 operations.

UNCLAS/FOUO



# PORT STATUS MATRIX



UNCLAS/FOUO 0400Z 09 FEB 10

Alternate Port Name	Port Status	Future Plans / Notes
Lafiteau	<u>Fully Available</u>	This port has two sections of pier, 30m LOA, water depth is 10 meters. Older, stable main pier has the damaged drybulk loading tower, which is being torn down--completion date (2/6). This will allow mooring for side load Ro/Ro and/or Lo/Lo ops. Offshore mooring buoys are present and can moor 160m vsls. Facility is approx 10 miles north of PaP (APN), road is paved and good.
St. Marc	<u>Fully Available</u>	2.5 Hour Transit from PaP. Serves local area.
Labadee	<u>Fully Available</u>	Receiving Cruise Ships and Relief Cargo.
Gonaives	<u>Fully Available</u>	Primarily serves small local area.
Port de Paix	<u>Fully Available</u>	Primarily serves small local area.
Cap Haitien	<u>Fully Available</u>	Single Cargo Crane and Single Road Access.
Jacmel	<u>Fully Available</u>	Pier measured 175 ft in length, 10ft pier height and a max depth along the pier of 20ft. The UN on scene is providing security with a Canadian medical unit treating the local population.
Petit Goave	<u>Partially Available</u>	Pier has collapsed but Ro/Ro ramp is accessible and has been used by LCU's and LCM "MIKE boats". Ramp in moderate condition but only flat bed or box trucks should be used.
Miragoane	<u>Fully Available</u>	Primarily serves small local area.

UNCLAS/FOUO



# Immense Resources Available

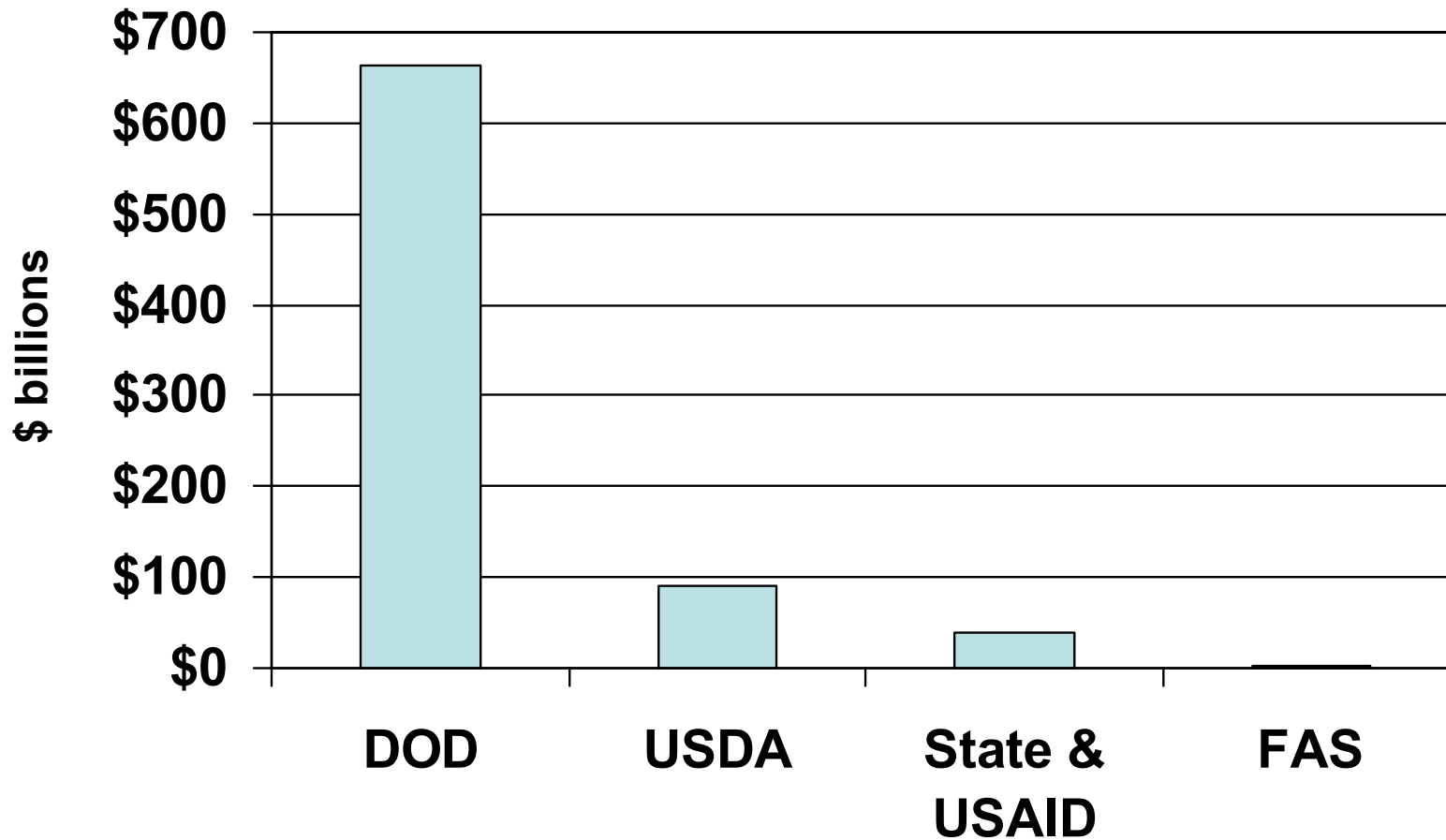

# Navy Engineers for Pier Repair

Tents to accommodate U.S. Navy Sailors from Amphibious Construction Battalion (ACB) 2 are photographed at "White Beach" on Varreoux Beach, Port Au Prince Haiti, Feb. 21, 2010.



**USDA Foreign Agricultural Service**

**Office of Global Analysis**



# WFP Surge 1B Update



Operation UNIFIED RESPONSE

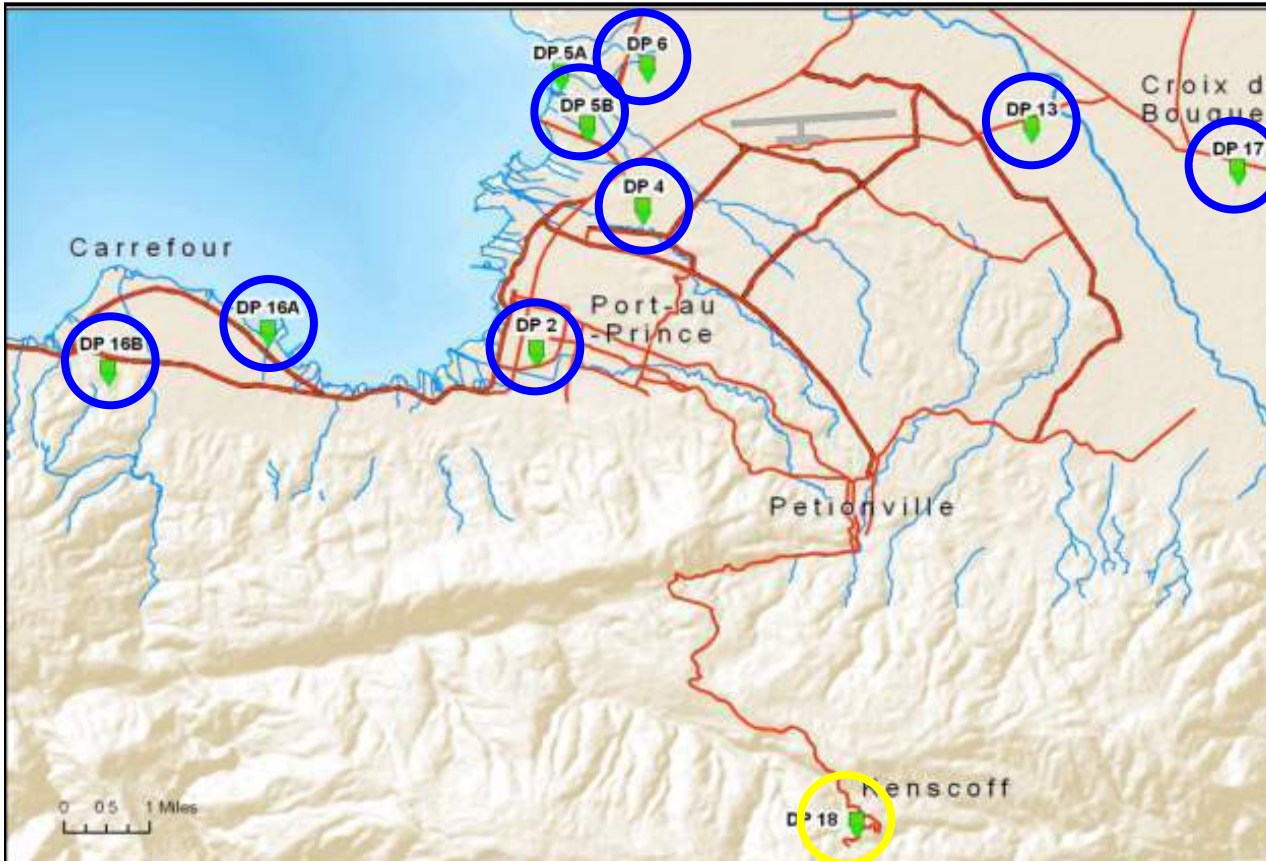

**HIGHLIGHTS:**

- 8 of 9 Distribution Points open 15Feb
- 16Feb will be the first day of distribution to Kenscoff; mountainous region south of PaP

**FUTURE SCHEDULE:**

- 16Feb: All 9 DPs scheduled to be open
- 20Feb: Last day of Phase IB Surge

**Families Given Food on 15Feb (by Distribution Point):**  
 As reported by NGOs

	15FEB10
	16FEB10

2 – 2,982	6 – 3,112	16b – 1,700
4 – 1,696	13 – 1,700	17 – 1,952
5 – 3,384	16a – 3,400	18 – 0





# Logistics



## Operation UNIFIED RESPONSE



### PaP Barge 410 “ APN Red Dock”

- Fully Mission Capable 13 FEB near PaP South Pier. The Pafilia was the first ship to discharge cargo using the barge pier. This will increase speed of discharge.

### Logistics Efforts

#### Current

- Crowley Barge project

#### Logistics Sync w/JTF-Haiti

- AAFES load on o/a 25 Feb

#### Interagency Logistics Support

- Debris Removal Strategy Plan

# Getting Food to People Essential



Courtesy Southcom



**USDA Foreign Agricultural Service**

**Office of Global Analysis**



# Getting Shelter Also Key

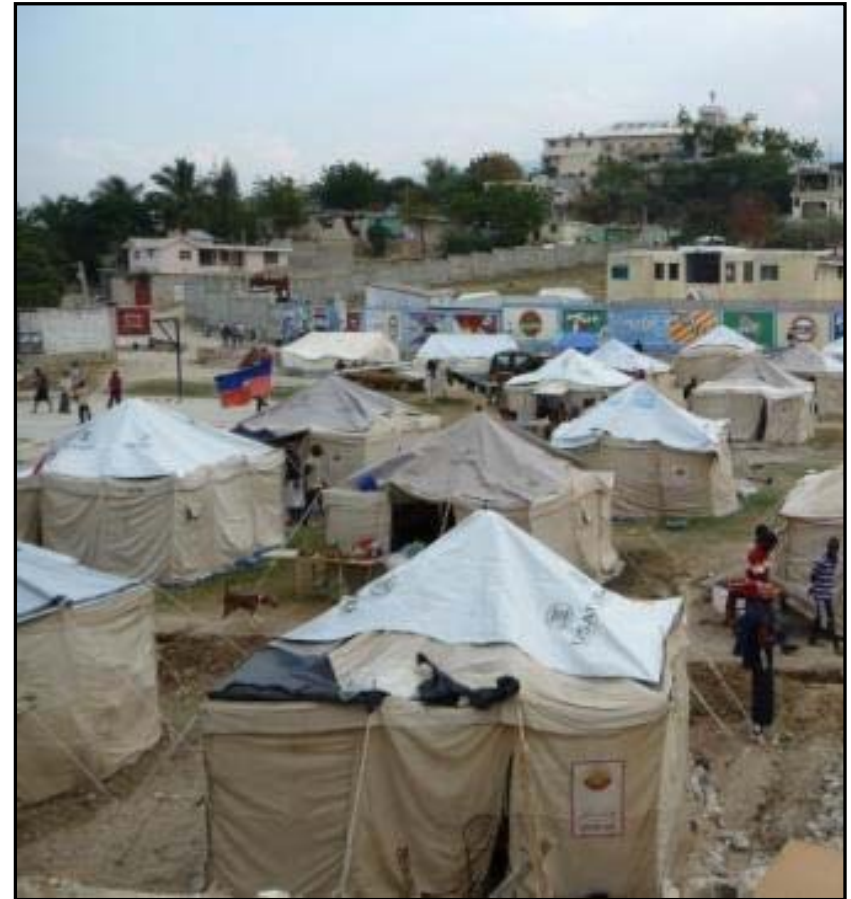

Courtesy Southcom



**USDA Foreign Agricultural Service**  
**Office of Global Analysis**



# Unity of Effort

(Interagency, International & Non-Governmental)



Operation UNIFIED RESPONSE



## GOH:

GOH revised the population estimate of PaP from 3M to over 3.7M ppl. This will provide a more accurate indicator for shelter needs, estimated to be 1.2M people that require shelter assistance.

## DOS:

- Canadian PM Harper began a two-day visit 15 Feb and will meet with Pres. Preval and PM Bellerive.
- Haiti is Canada's 2nd-largest aid recipient after Afghanistan.
- Haiti's state of emergency is scheduled to expire on 16 Feb.

## HHS:

Health & Human Services' Disaster Medical Assistance Response Teams are scheduled to completely demobilize by end of Feb.

## UN:

- WFP announced the establishment of a Task Force for Food Security in Haiti. The Task Force will support GOH in the implementation of a concerted, coherent and targeted, immediate and longer-term food security strategy that integrates agricultural production, and social safety nets.
- The debris management task force is meeting on 16 Feb to discuss and draft a debris management plan, focusing on PaP and submit a plan o/a 23 Feb.
- Water provided through distribution networks in PaP will be chlorinated in the coming weeks.
- Water quality monitoring plan promoting residual chlorine monitoring in the distribution network and water bladders at settlement site locations will be in place by the end of Feb.



UNCLASSIFIED



# MINUSTAH

## Operation UNIFIED RESPONSE

**MINUSTAH Total Force Strength:**

- Authorized 8,940
- Actual 8051

**2/82 BCT AO**

- 3,338 total Troops consisting of the following:
- 3 x IN BN +/- 2,173 Total Troops
- 3 x AVN CO
- Hospital (Level II Care)
- 2 x EN CO
- MP CO
- Maritime CO

**22 MEU AO**

- 2 x IN BN(+) consisting of 971 total Troops

**Past 24 Hours**

- 303 x security patrols in PAP
- 343 x security patrols o/s PAP
- 5 x HA missions in PAP
- 11 x HA missions o/s PAP

**Next 24 Hours**

- 16 x HA missions scheduled



- URUGUAY
- SRI LANKA
- JORDAN
- ARGENTINA
- CHILE
- BOLIVIA
- BRAZIL
- NEPAL

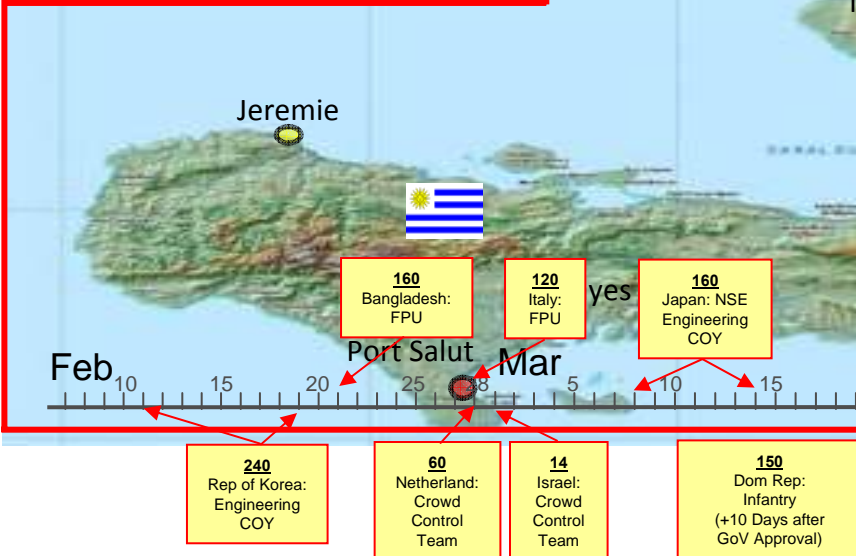



# Non-MINUSTAH Troops



## Operation UNIFIED RESPONSE

**Ships in JOA**

DDH HMCS ATHABASKAN	MED ARM HUASTECO
FFH HMCS HALIFAX	AMPHIB ARM USUMACINTA
CARRIER ITS CAVOUR	LOG ARC BUANAVENTURA
LPD SPS CASTILLA	

as of 15 FEB 10, 0700

- CANADA
- COLUMBIA
- FRANCE
- ITALY
- MEXICO
- SPAIN
- SWITZ.
- UK



**Expected**

RFA LARGS BAY – 18 Feb
FS SIROCO (Return) – TBC
SEDENA Fd Kitchen – Date TBC



# 24 Hour Mudslide Threat

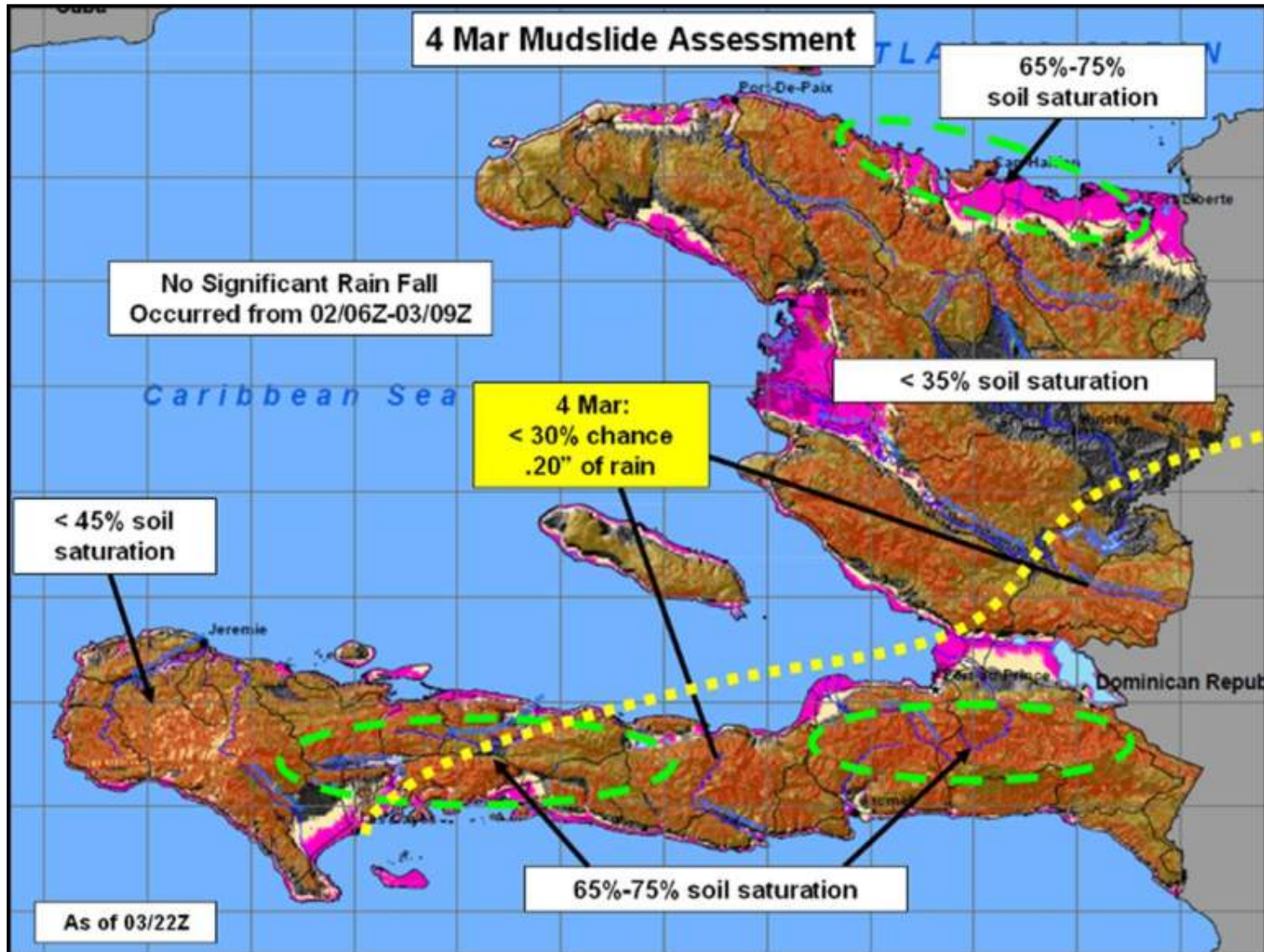

**USDA Foreign Agricultural Service**  
**Office of Global Analysis**

# The Americas are the most important region for the United States



**USDA Foreign Agricultural Service**

**Office of Global Analysis**

# February 27: Earthquake in Chile

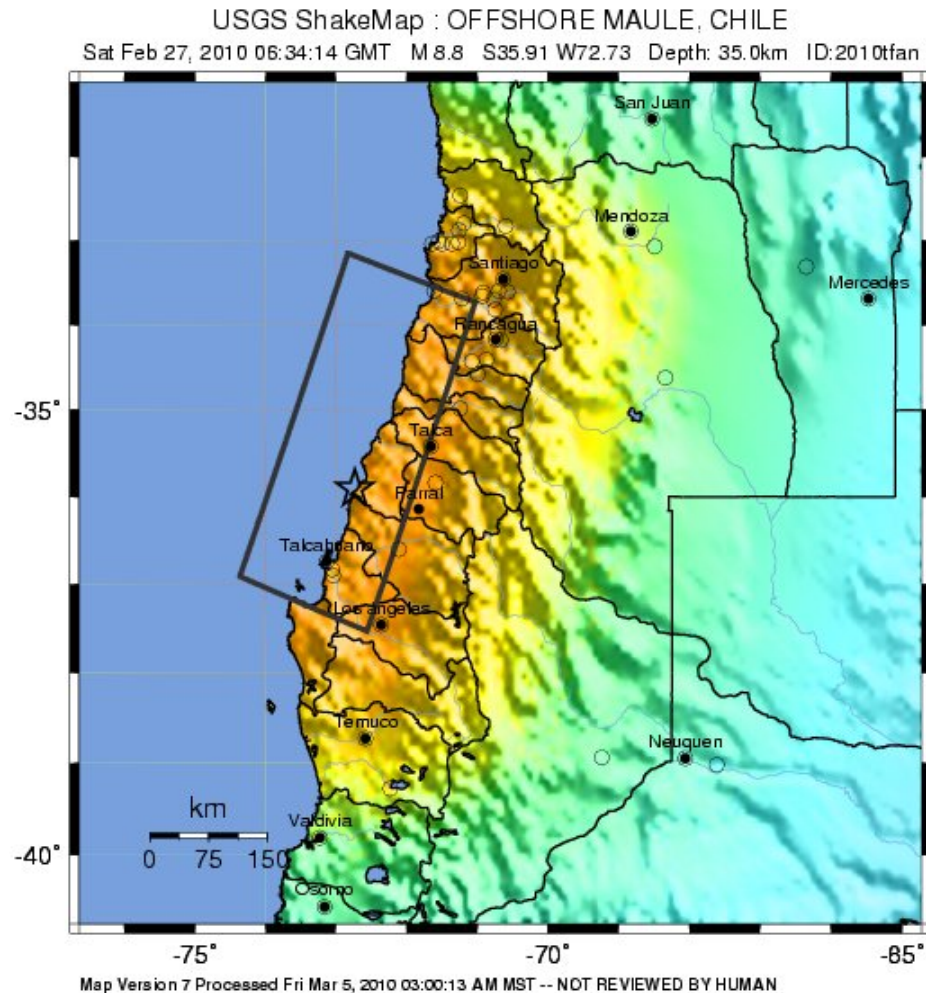

**USDA Foreign Agricultural Service**  
**Office of Global Analysis**



# Haiti: Opportunity Areas for Light Industry, Tourism, and Agricultural Production

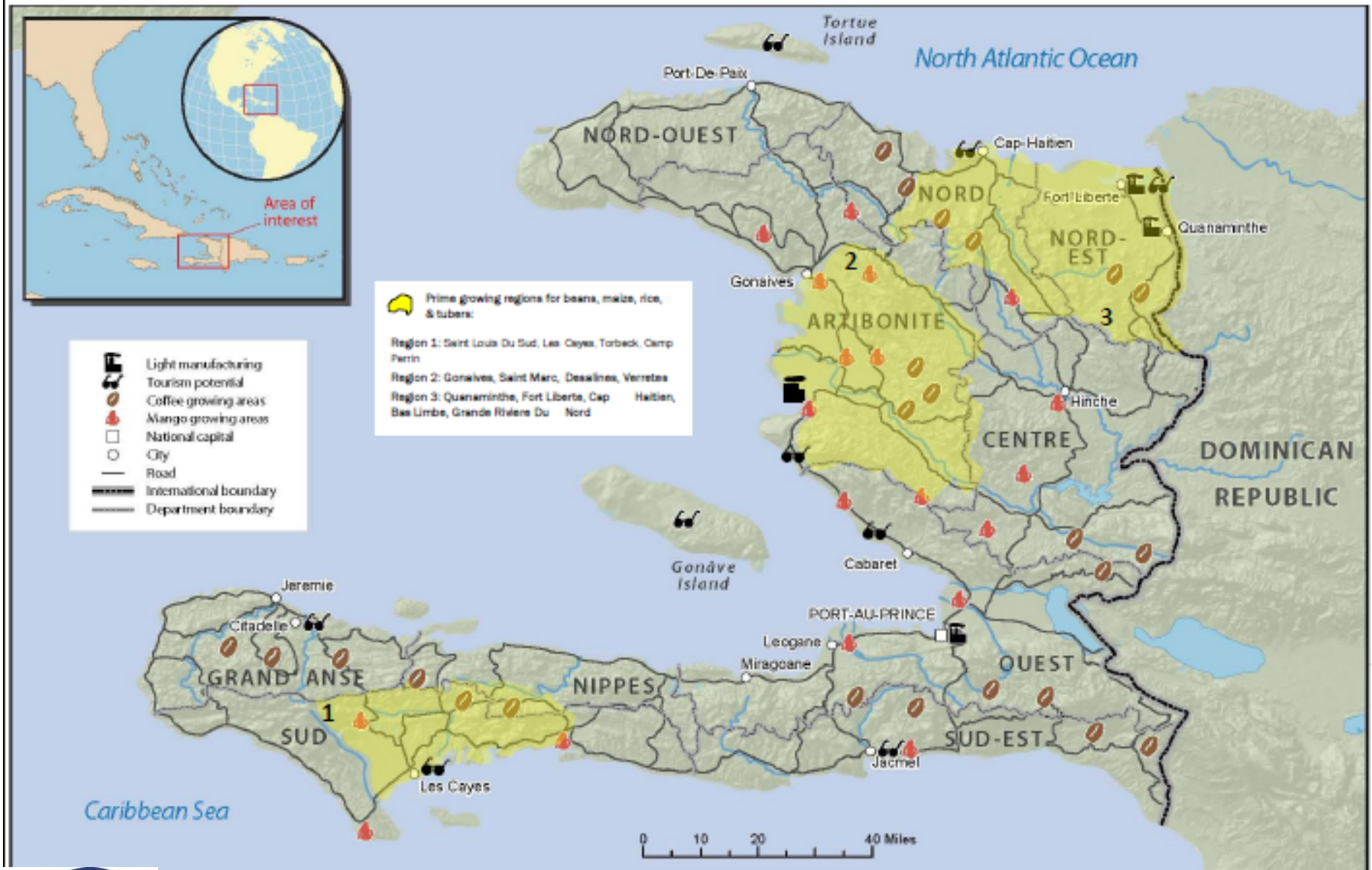

**USDA Foreign Agricultural Service**  
**Office of Global Analysis**

# Corn production and trade flow

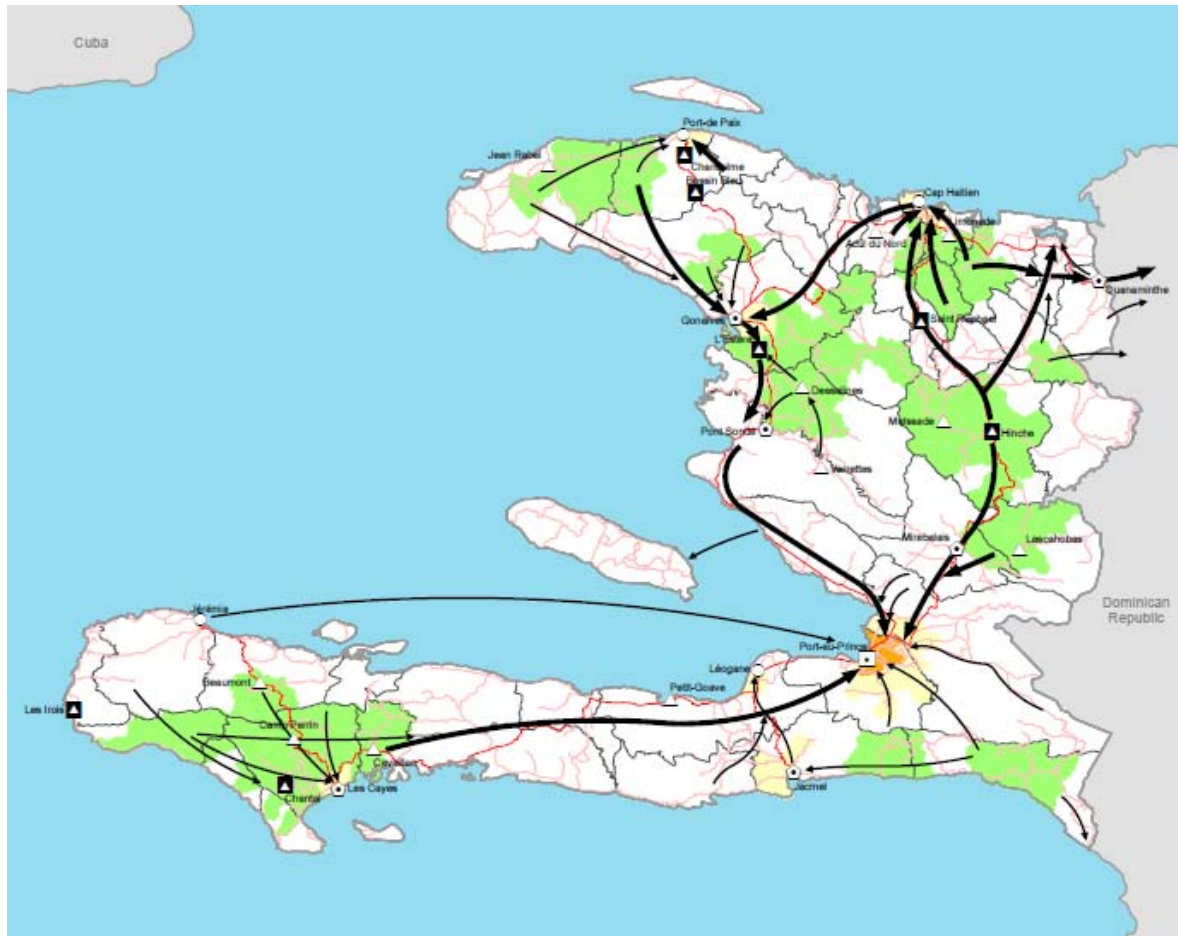

## Key Market Centres

- Retail
- Wholesale
- △ Assembly
- ◻ Retail & Wholesale
- ▲ Retail & Assembly
- ◼ Assembly & Wholesale
- ⊙ Assembly, Wholesale & Retail

## Production Suplus/Deficit

- Major Production/Surplus
- Minor Deficit
- Major Deficit

## Trade Flow

- Large Flow
- Small Flow

## Road Types

- Main Roads
- Minor Roads



**USDA Foreign Agricultural Service**  
**Office of Global Analysis**



# Rice production and trade flow

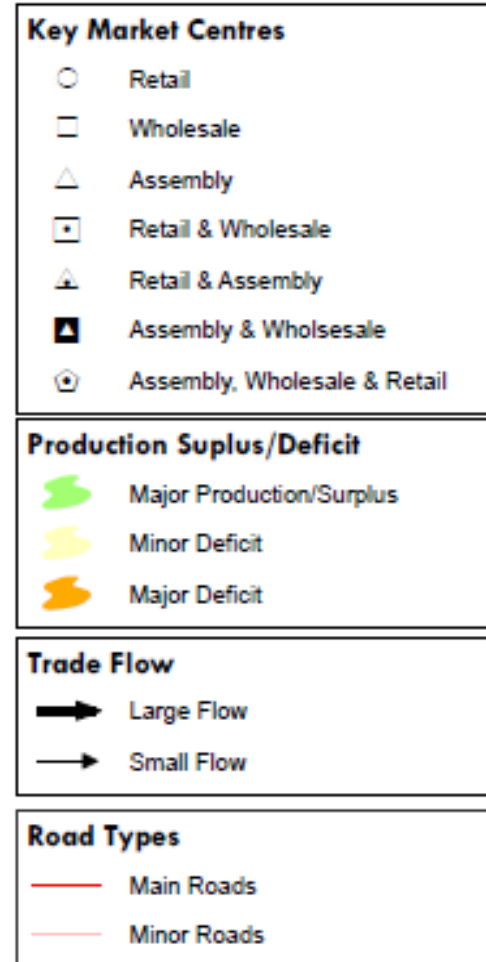
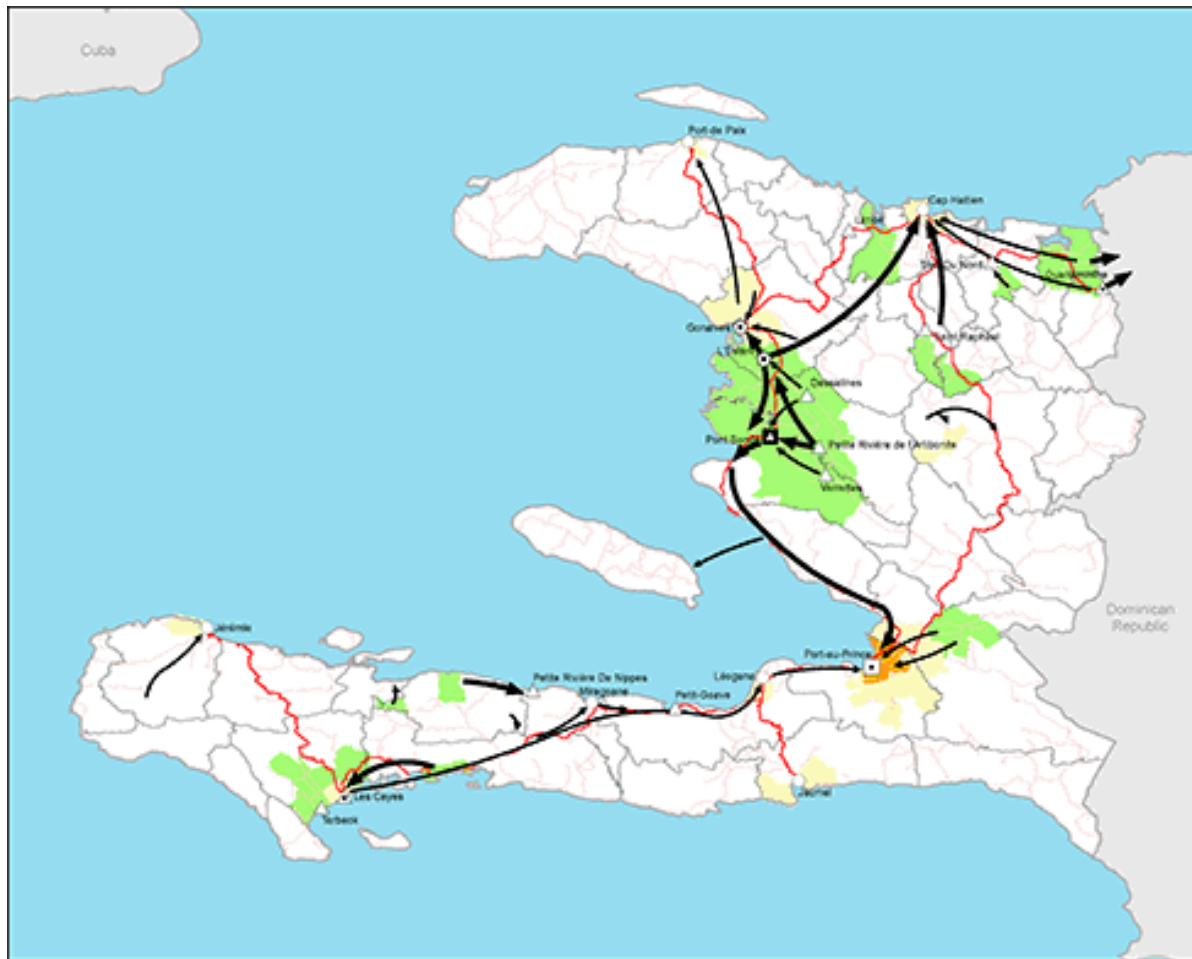

**USDA Foreign Agricultural Service**  
**Office of Global Analysis**

# Bean production and trade flow

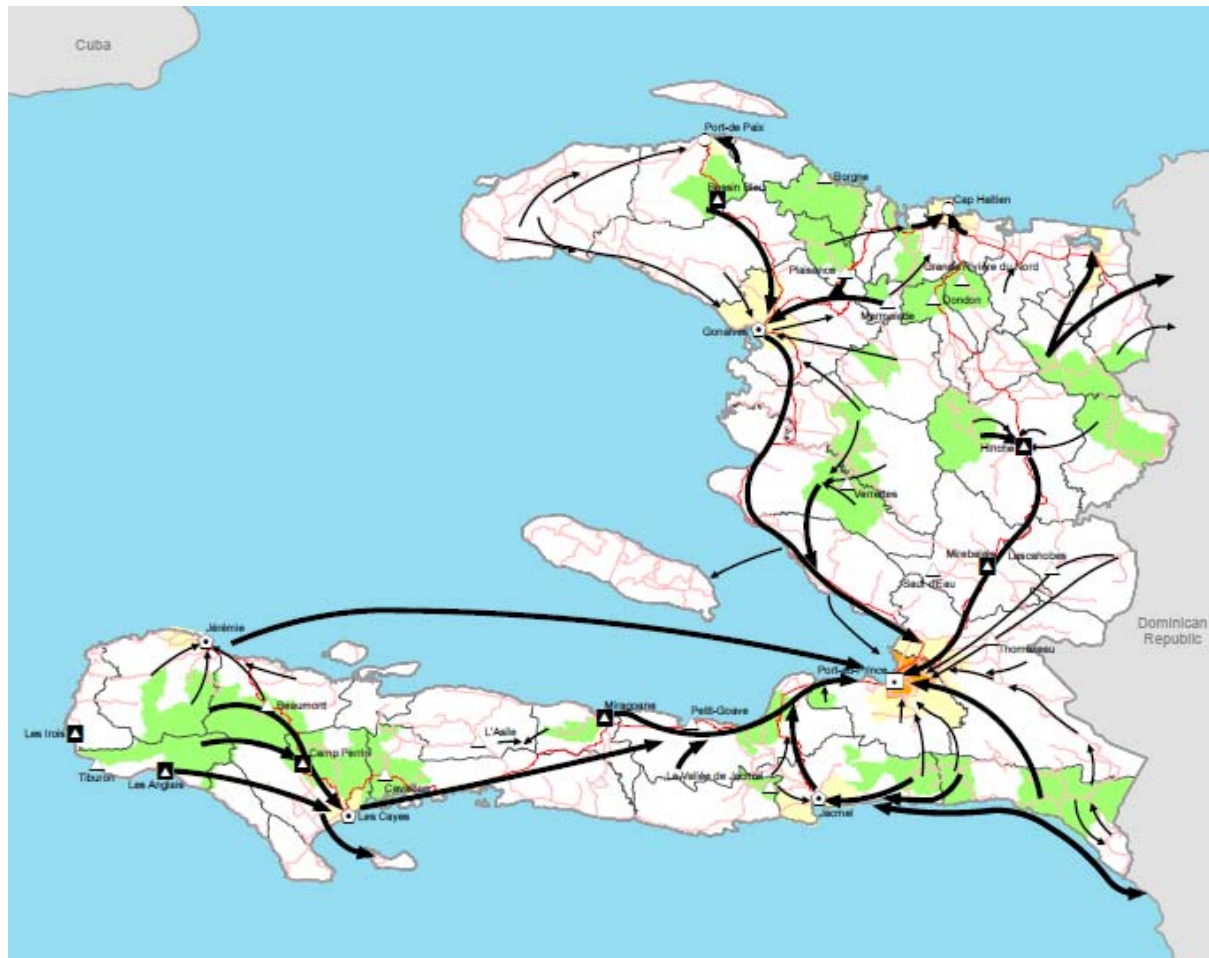

## Key Market Centres

- Retail
- Wholesale
- △ Assembly
- ◻ Retail & Wholesale
- △ Retail & Assembly
- ◼ Assembly & Wholesale
- ◻ Assembly, Wholesale & Retail

## Production Surplus/Deficit

- Major Production/Surplus
- Minor Deficit
- Major Deficit

## Trade Flow

- Large Flow
- Small Flow

## Road Types

- Main Roads
- Minor Roads



**USDA Foreign Agricultural Service**  
**Office of Global Analysis**

# Haiti's Merchandise Exports

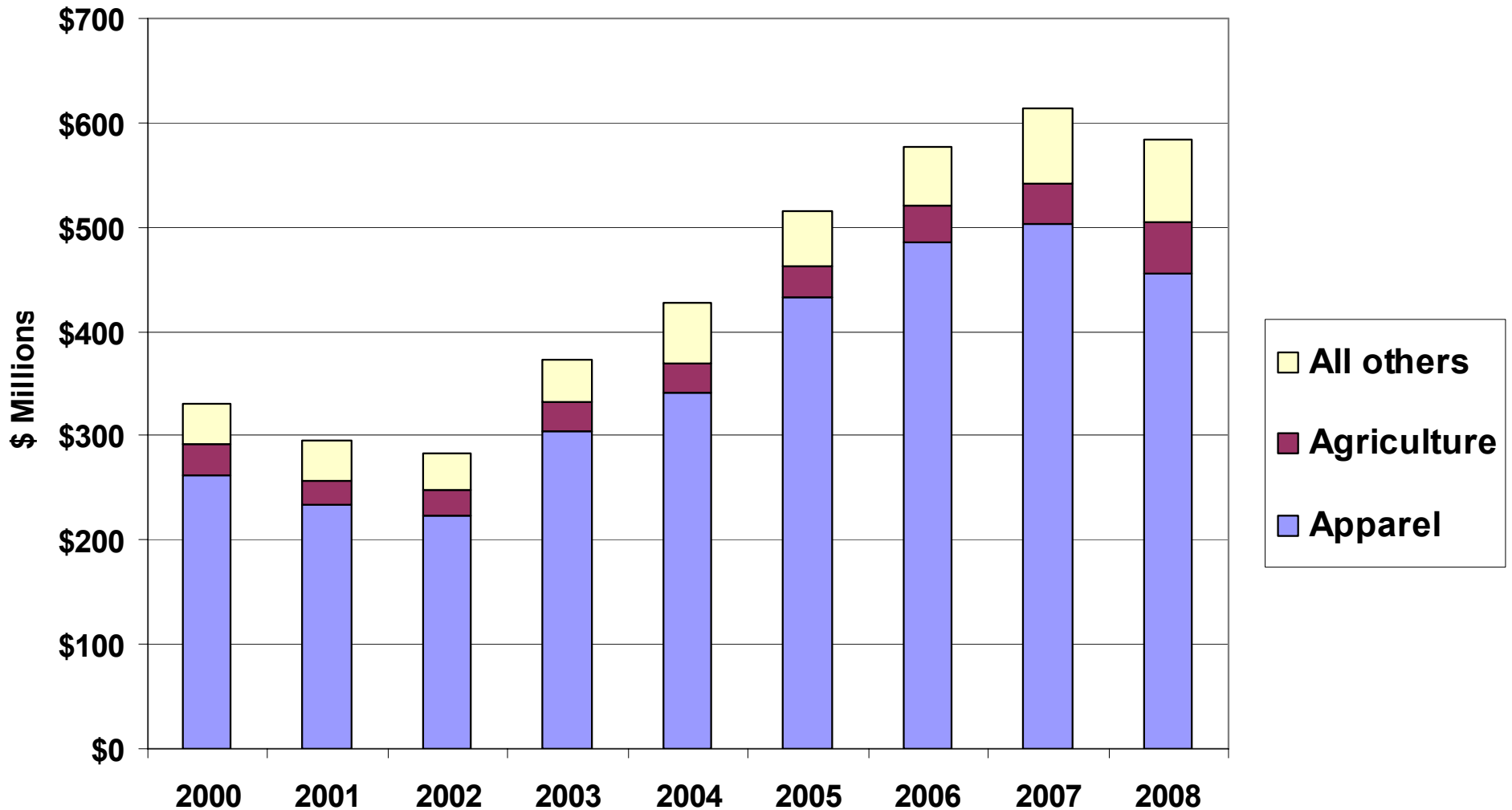

**USDA Foreign Agricultural Service**

**Office of Global Analysis**

# Haiti's Agricultural Exports

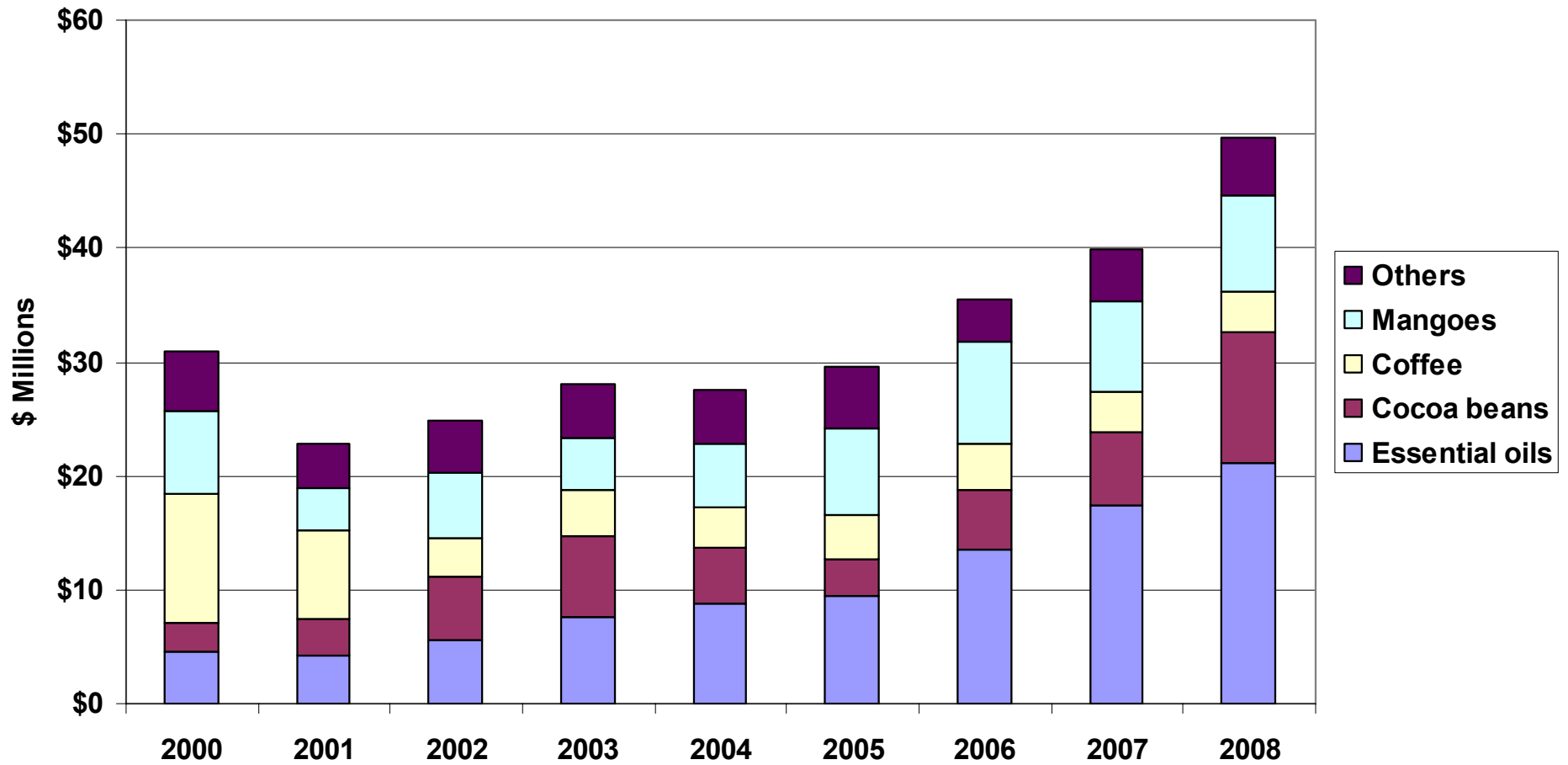

**USDA Foreign Agricultural Service**

**Office of Global Analysis**

# Haiti's Agricultural Imports

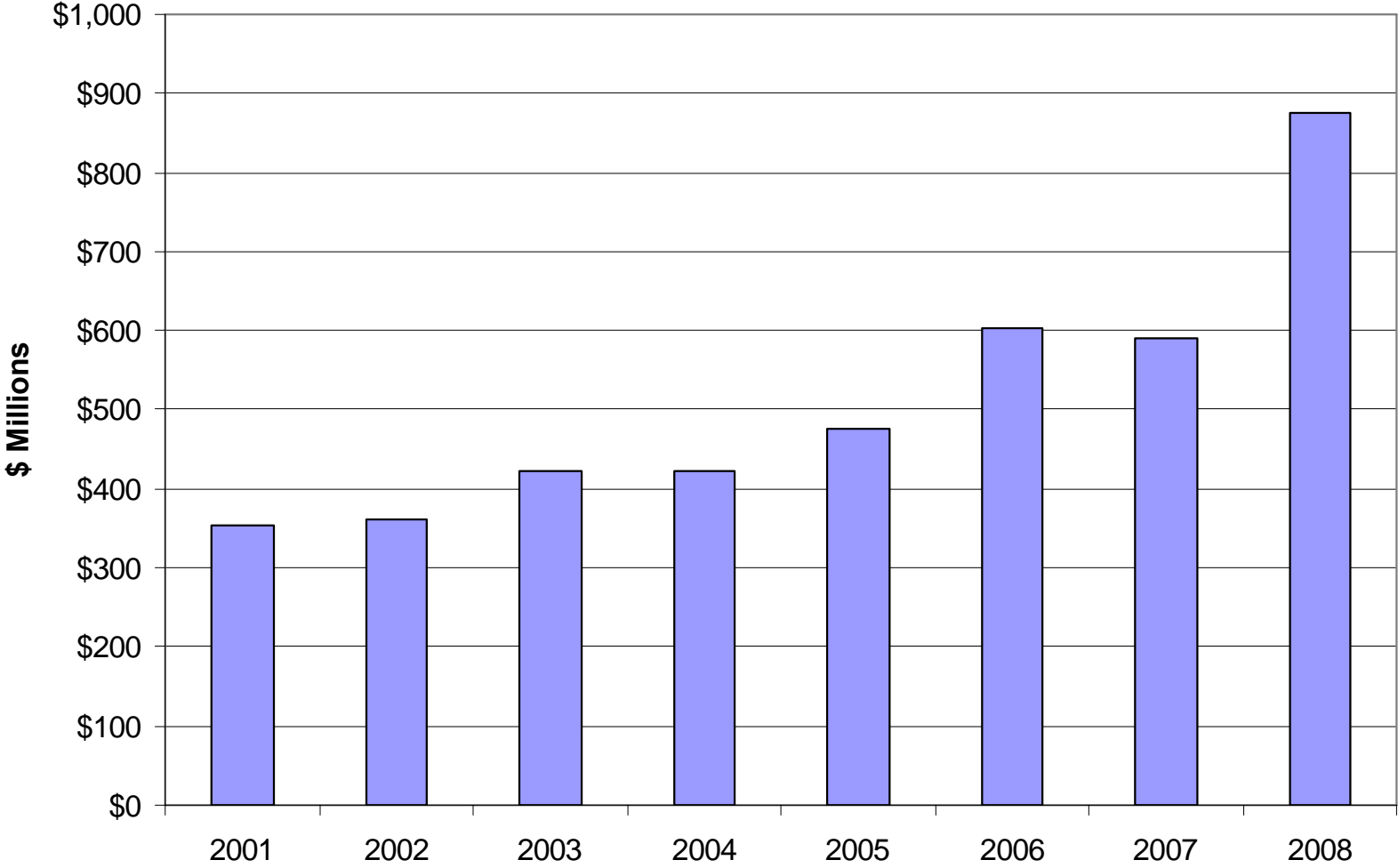

**USDA Foreign Agricultural Service**  
**Office of Global Analysis**



**Thanks for your attention!**

**Questions / comments**

Email: [mark.thompson@fas.usda.gov](mailto:mark.thompson@fas.usda.gov)

Phone: 202-720-7741



**USDA Foreign Agricultural Service**

**Office of Global Analysis**