



AgEcon SEARCH
RESEARCH IN AGRICULTURAL & APPLIED ECONOMICS

The World's Largest Open Access Agricultural & Applied Economics Digital Library

This document is discoverable and free to researchers across the globe due to the work of AgEcon Search.

Help ensure our sustainability.

Give to AgEcon Search

AgEcon Search

<http://ageconsearch.umn.edu>

aesearch@umn.edu

*Papers downloaded from **AgEcon Search** may be used for non-commercial purposes and personal study only. No other use, including posting to another Internet site, is permitted without permission from the copyright owner (not AgEcon Search), or as allowed under the provisions of Fair Use, U.S. Copyright Act, Title 17 U.S.C.*



United States Department of Agriculture



Using Behavioral Economics to Help SNAP Households Achieve a More Healthful Diet

Joanne Guthrie and Lisa Mancino, Economic Research Service
USDA Economists Seminar, November 17, 2014

Economic Research Service

www.ers.usda.gov

These are preliminary results and should not be attributed to ERS or the USDA





SNAP

the Supplemental Nutrition Assistance Program

- Designed to help low-income households purchase food
- In 2012, served 46.6 million participants/month



SNAP Benefits Target the Most Needy

SNAP benefits are well targeted to the poorest households, and almost half of benefits go to children

Distribution of SNAP benefits by poverty status of household, 2010 (percent)

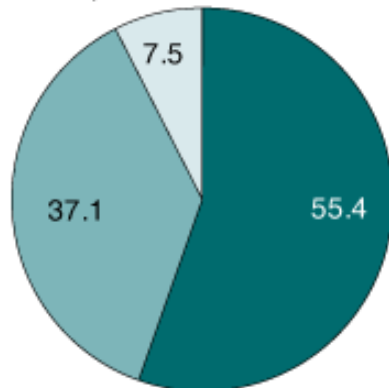

- Income less than 50 percent of poverty line
- Income between 50 and 100 percent of poverty line
- Income above poverty line

Distribution of SNAP benefits by age of recipient, 2010 (percent)

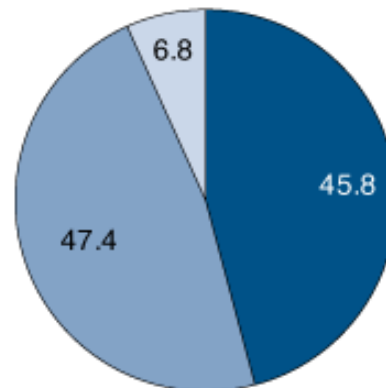

- Children
- Adults age 18-59
- Elderly

SNAP = Supplemental Nutrition Assistance Program.

Source: USDA, Economic Research Service using data from USDA, Food and Nutrition Service.



ERS Research shows SNAP alleviates poverty, particularly among households with children

The effect of SNAP in reducing child poverty measures increased steadily from 2000 to 2008 and then jumped in 2009

Percent reduction in child poverty measures when SNAP benefits are added to family income

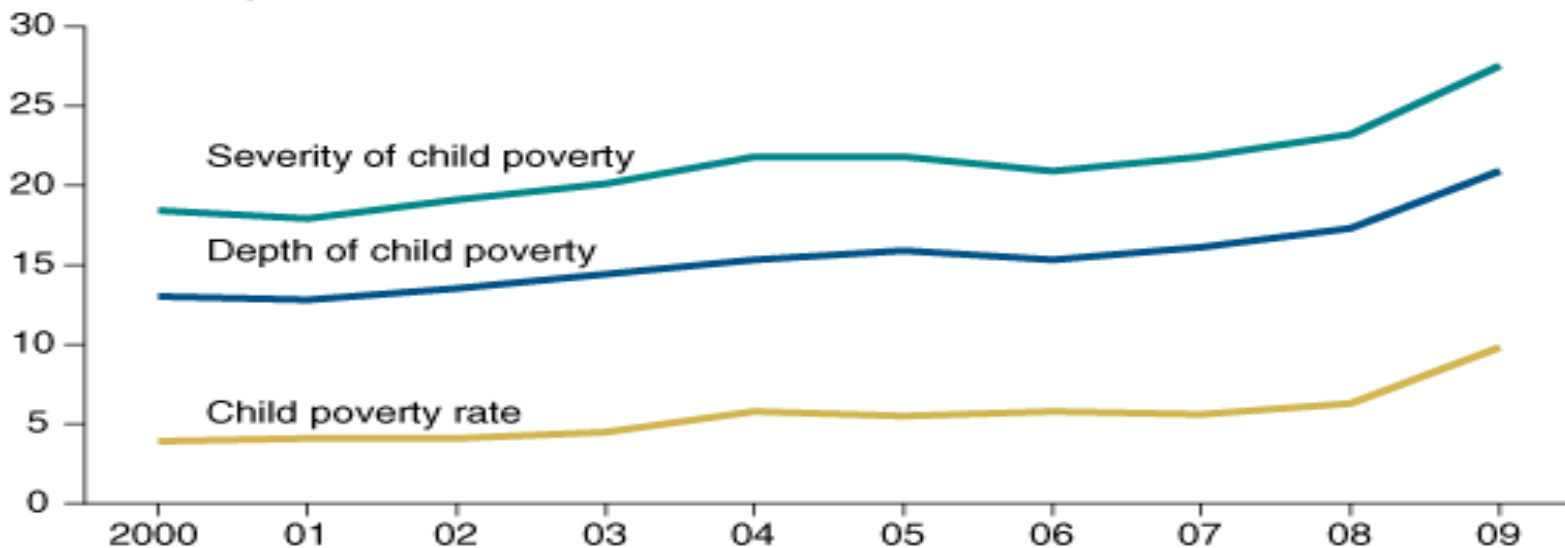

The depth of poverty is measured by the "poverty gap," an index reflecting the average distance of poor households' incomes below the poverty threshold. Severity of poverty is measured by an index reflecting the square of the poverty gap.

SNAP = Supplemental Nutrition Assistance Program.

Source: USDA, Economic Research Service using data from the Current Population Survey Annual Social and Economic Supplement.

Source: Alleviating Poverty in the United States: The Critical Role of SNAP Benefits by Laura Tiehen, Dean Jolliffe, and Craig Gundersen (Economic Research Report-132) April 2012



SNAP reduces food insecurity

The prevalence of very low food security declined among households with incomes in the eligibility range for SNAP but not for households with incomes somewhat higher

Percent of households with very low food security

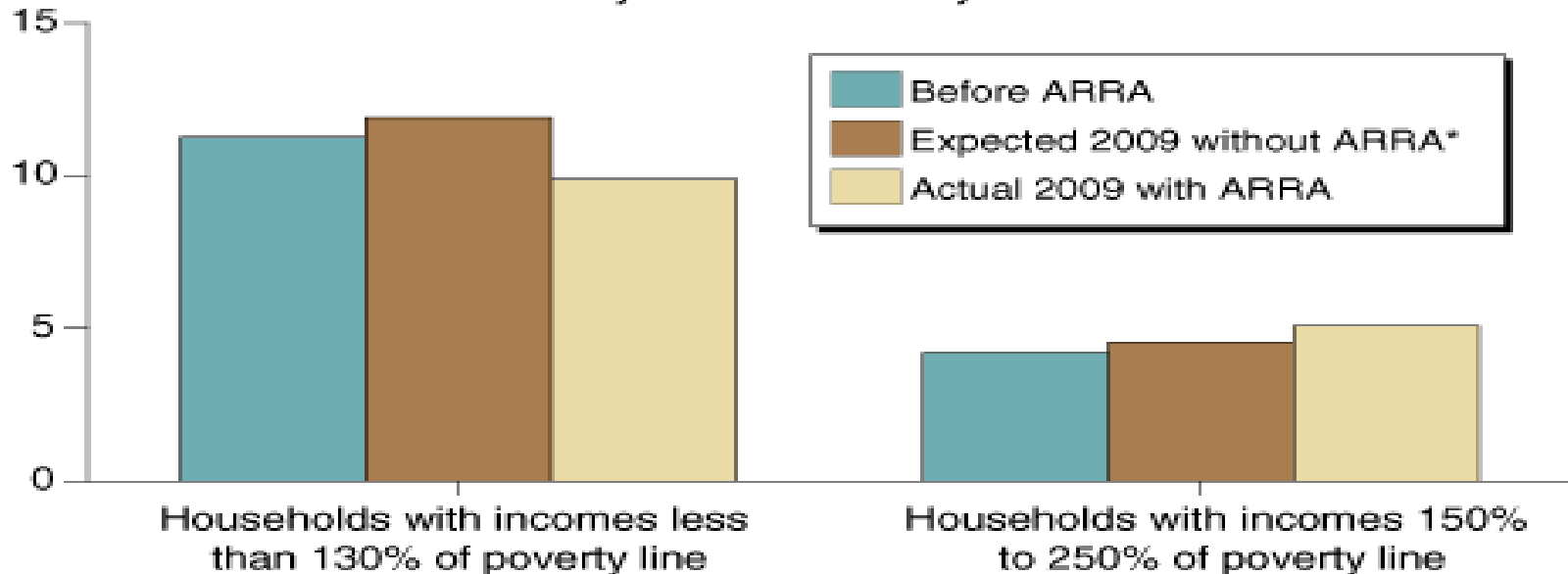

*Regression-based estimates taking into consideration changes from 2008 to 2009 in household income, employment, and other characteristics, but not changes in food prices.

Source: USDA, Economic Research Service calculations using Current Population Survey Food Security Supplement data.

Source: Food Security Improved Following the 2009 ARRA Increase in SNAP Benefits, by Mark Nord and Mark Prell, ERR-116, USDA, Economic Research Service, April 2011.



But SNAP Has Less Success Improving Diet Quality

Daily intake relative to HEI-2010 and target densities (intake/1,000 calories) in 2010 *Dietary Guidelines*

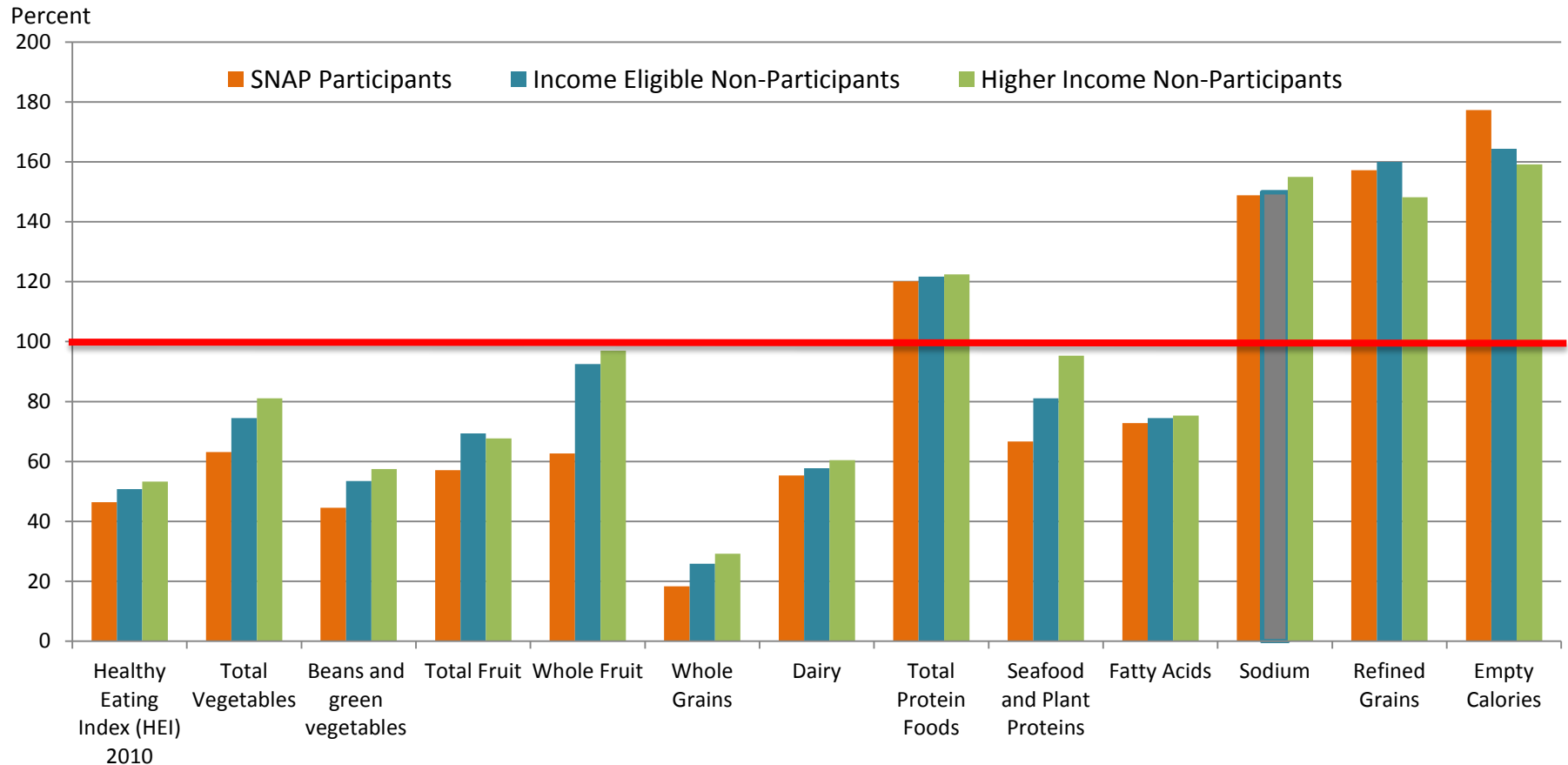

Source: ERS analysis of 2003-10 National Health and Nutrition Examination Survey



SNAP participants tend to have poor health outcomes too

	SNAP participants	Income eligible non-participants	All other adults
BMI	29.816	28.150	28.219
Overweight	71.2%	64.7%	67.7%
Obese	43.2%	33.1%	32.2%
Weight gain (1 year)	3.54 lbs	.627 lbs	-.455 lbs
Diabetes	8.16%	7.85%	6.25%
Stroke	4.46%	2.95%	1.64%
Score on depression screener	6.29	3.86	2.67

Source: ERS Calculations using NHANES, 2003-2010, except depression screener (2005-2010)



Can We Do More to Help Improve Food Choices?

First Step: Understand SNAP participants better



Data on dietary habits, awareness, and attitudes

- National Health and Nutrition Examination Survey (NHANES), 2003-2010
- ERS funded Flexible Consumer Behavior Survey (FCBS) 2007-10 (+ a few questions in 2005-6)

	Adult SNAP participants with PIR≤1.85	Income eligible adult non-participants PIR≤1.85	All other adults PIR > 1.85	Total adult sample
2005-06	178	1283	2410	3871
2007-08	467	1422	2342	4231
2009-10	651	1474	2423	4548



Is it— lack of information about nutrition?

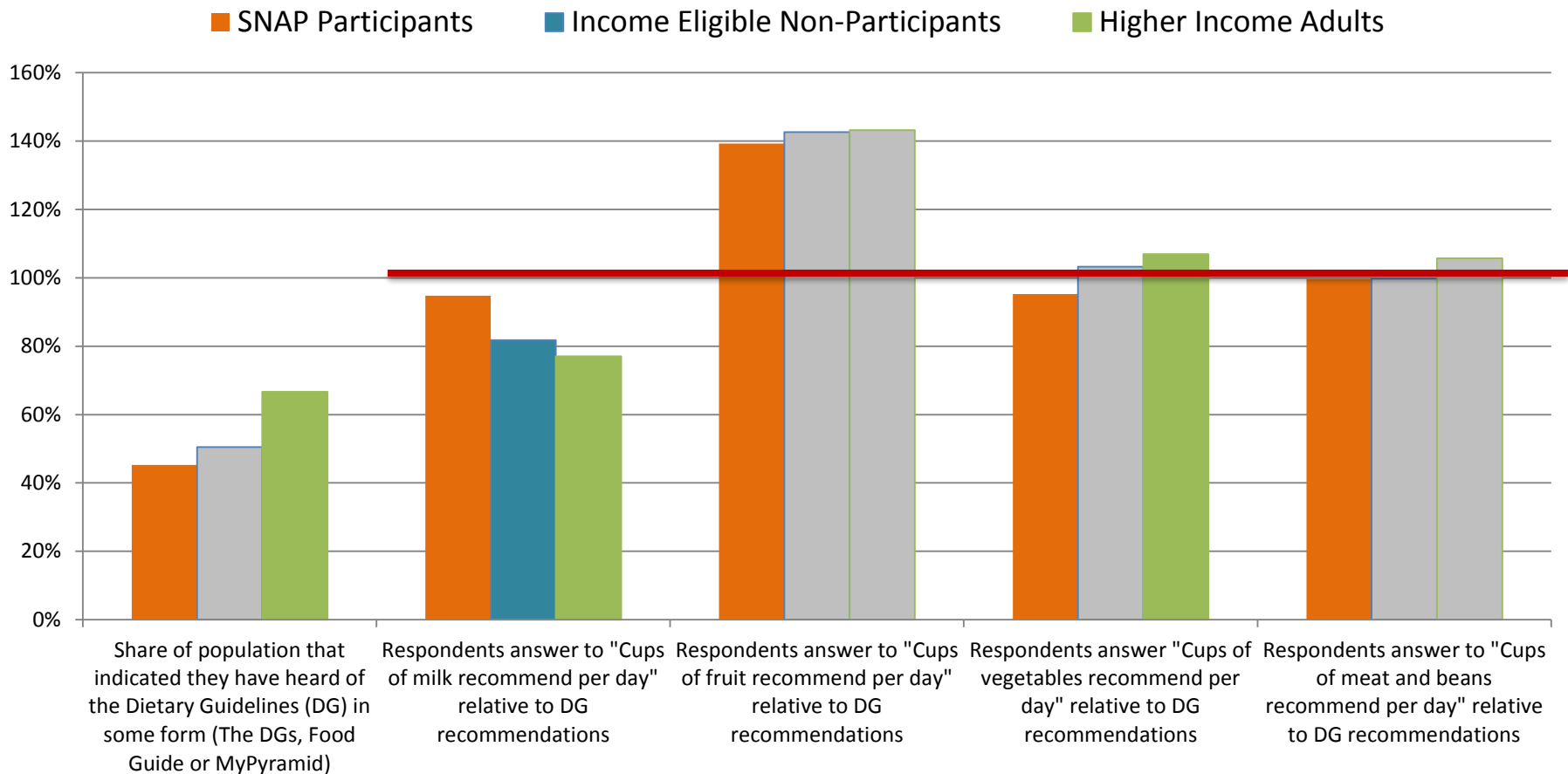

Source: ERS calculations of 2007-10 FCBS data; Grey columns do not differ from SNAP participants with $p < .05$.



SNAP participants value nutrition but other priorities compete

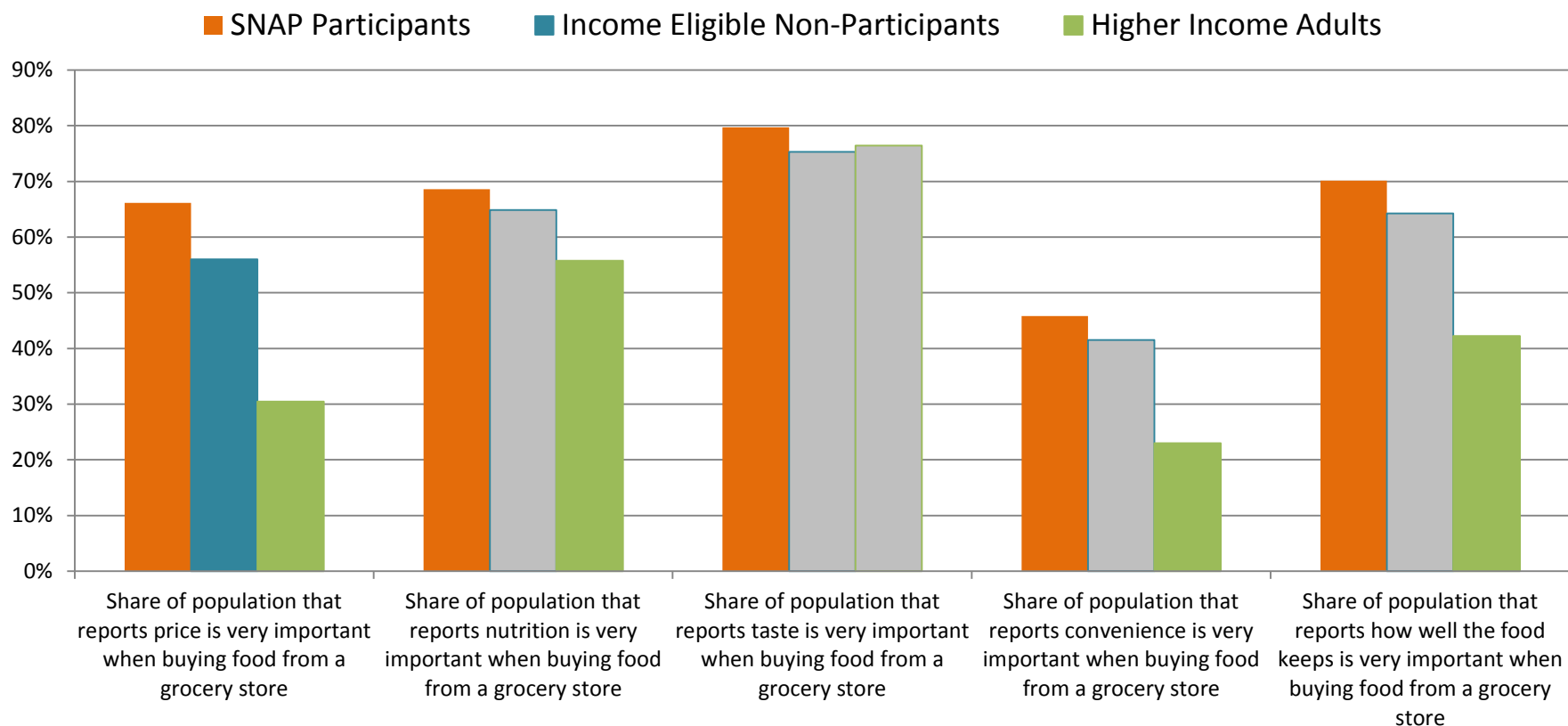

Source: ERS calculations of 2003-10 NHANES data; Grey columns do not differ from SNAP participants with $p < .05$.



SNAP participants may also feel more pressured by money and time constraints

	SNAP participants	Income eligible non-participants	All other adults
Per-person expenditures on food from grocery stores over past 30 days	\$ 101.09	\$ 109.12	\$ 148.46
Per-person expenditures on eating out over past 30 days	\$ 18.29	\$ 33.97	\$ 83.64
Per-person expenditures on carryout/delivery over past 30 days	\$ 3.28	\$ 5.70	\$ 9.94
Share of population that shops weekly or more	42%	55%	65%
Share of population that shops monthly or less	28%	15%	8%
Average amount of time (minutes) it takes to get to grocery store	16	15	13
Share of population that needs more than 30 minutes to reach a grocery store	14%	14%	8%

Source: ERS Calculations using NHANES, 2007-2010; Differences between SNAP and non-SNAP participants significant at $p < .05$.



SNAP participants may be more pessimistic about the value of dietary change

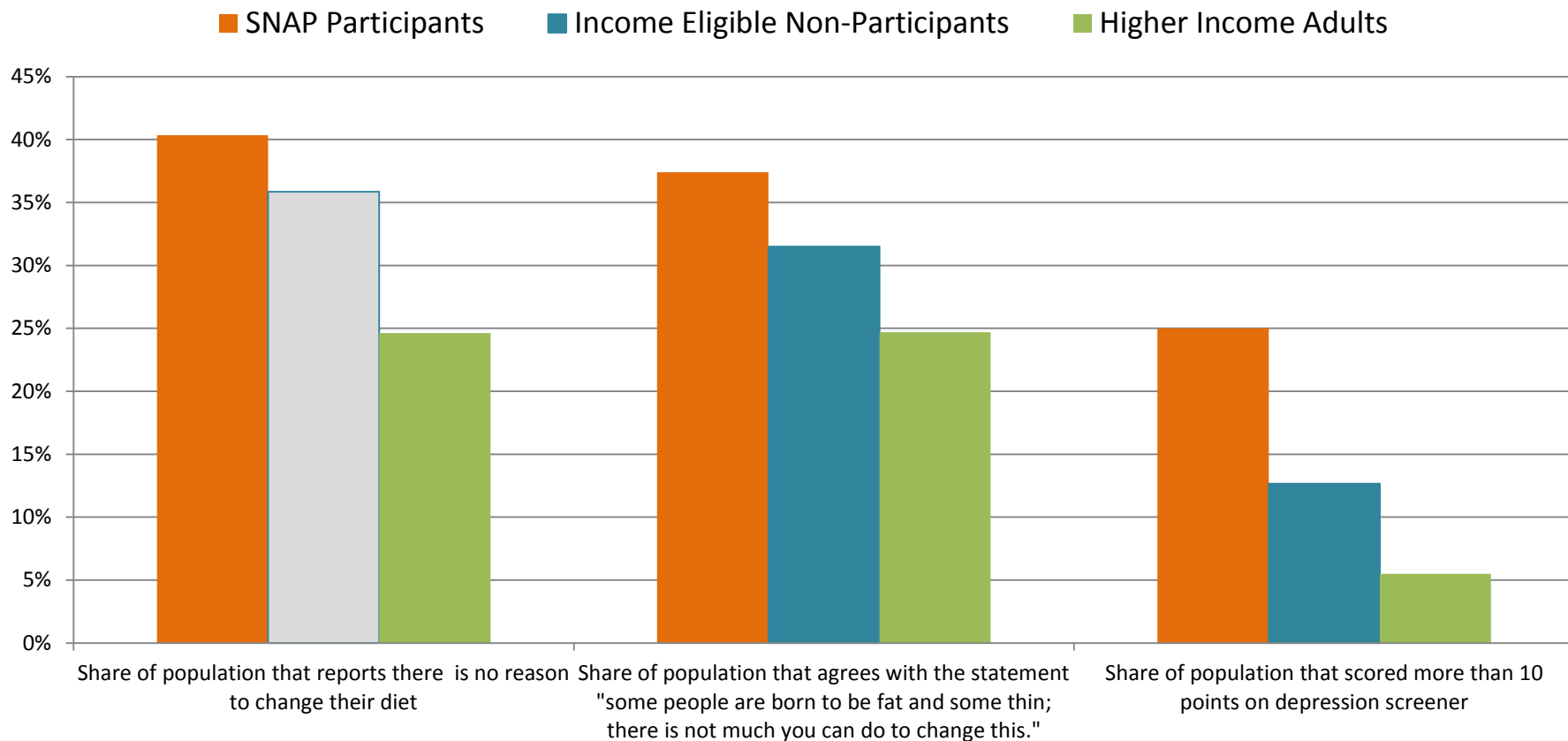

Source: ERS calculations of 2007-10 NHANES data; Grey columns do not differ from SNAP participants with $p < .05$.



Take away points about SNAP participants

- Diets and health need improving
- Value nutrition as much as other consumers
- More pessimistic about the value of making dietary improvements
- More likely to shop once a month and may have a harder time getting to the store
- Time and money complicate the task of making healthier food choices



Can Behavioral Economics Suggest Solutions?

- Traditional economics/Nutrition education
 - People have consistent preferences, and given adequate information, will understand what is best for them and will act accordingly
 - *But sometimes this doesn't change behavior and outcomes*



Behavioral Economics

- Offers insights into why observed behavior appears “irrational” —that is, it doesn’t follow traditional economic ideas of how consumers should react to information
- Suggests new approaches to helping consumers make healthy choices



Insights from Behavioral Economics

Good Nutrition is a Long-Term Goal But Food Choice Is a Short-Term Decision

- **Inconsistent preferences**

- Long-term health vs. short-term enjoyment
- Shorter time horizons associated with greater problems of self-control
- Visceral factors and distractions may further shift focus to the present

Go Find Healthy Lunch or Grab Something from the Vending Machine?

I'm hungry, I don't have much time for lunch, this candy bar looks delicious, it's right here—and any health effects are a long time away





Good Nutrition Is the Product of Many, Many Short-Term Food Decisions



Makes It Easy for Good Intentions to Be Undermined by Inconsistent Decisions



Insights from Behavioral Economics

How choices are presented influences behavior



- the “default”

- What’s visible, easy



- Cues such as package size, serving plates, bowls



Reconsidering Choice Architecture

How Can We Make the Healthy Choice the Easy, Automatic Choice?



- Making the Healthy Option the default

- Package sizes, serving dishes that provide appropriate cues



- Healthy Express Lane Meals



Can We Apply These Ideas to Help SNAP Participants?

ERS-Organized Workshop, July 10, 2014



HEALTHY FOOD INCENTIVES WORKSHOP: EXPLORING WAYS TO NUDGE HEALTHY PURCHASES AMONG SNAP SHOPPERS

July 10, 2014 | Washington, DC



Some Ideas for Research

- “Nudging” via placement and other manipulations of choice architecture of grocery stores



Some Ideas for Research

Mental accounting—how much should be spent on fruits and vegetables or other healthful choices?



Collin Payne



The Half Cart

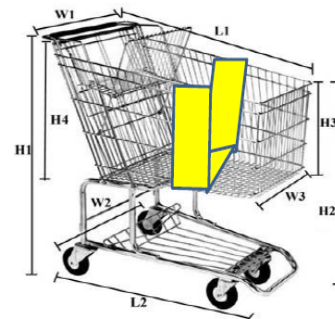

...with Brian Wansink @ Cornell U.

& Kenny Herbst @ Wake Forest U.

1. Salient
2. Easy to Interpret
3. Easy to Compare Against Current Behavior



Some Ideas for Research Precommitment

Make decision in “cold” emotional state

“Lock-in” so makes it harder to change because of short-term preference shifts



Pre-ordering Groceries



A Look Ahead

- More investigation of SNAP participant food choices and the factors that motivate them
 - Flexible Consumer Behavior Survey (FCBS)
 - National Household Food Acquisition and Purchase Survey (FoodAPS)
- ERS article “SNAP Households Must Balance Multiple Priorities to Achieve a Healthful Diet” and report in preparation
- Cooperative Research Agreement between ERS and New Mexico State University
- New Duke-UNC USDA Center for Behavioral Economics and Healthy Food Choice Research (BECR)

