



AgEcon SEARCH
RESEARCH IN AGRICULTURAL & APPLIED ECONOMICS

The World's Largest Open Access Agricultural & Applied Economics Digital Library

This document is discoverable and free to researchers across the globe due to the work of AgEcon Search.

Help ensure our sustainability.

Give to AgEcon Search

AgEcon Search

<http://ageconsearch.umn.edu>

aesearch@umn.edu

*Papers downloaded from **AgEcon Search** may be used for non-commercial purposes and personal study only. No other use, including posting to another Internet site, is permitted without permission from the copyright owner (not AgEcon Search), or as allowed under the provisions of Fair Use, U.S. Copyright Act, Title 17 U.S.C.*

Cotton seed oil

Cottonseed Oil Mill Simulation Model: Documentation and User's Guide

BILLY R. HISE

National Economics Division
Economics and Statistics Service
U.S. Department of Agriculture

and

Dept of Agricultural Economics Department
College of Agricultural Sciences
Texas Tech University
Lubbock, Texas

GIANNINI FOUNDATION OF
AGRICULTURAL ECONOMICS

DEC 15 1980

College of Agricultural Sciences Publication No. T-1-194
October, 1980

ABSTRACT

A computer model for simulating costs and returns of cottonseed oil mills was developed using an economic-engineering approach. This report documents the computer model and explains specific input cost items and output relationships of cottonseed processing. An example data set and a computer run based on that data set are used to assist in explaining the use of the computer model. Technical details for constructing a data set and using the computer model are given in the appendices.

Key words: Cottonseed oil mill, simulation model, computer model, costs, returns.

ACKNOWLEDGEMENTS

The author wishes to recognize the contributions and assistance of the following individuals: Don Ethridge and Dale Shaw with the Economics and Statistics Service (ESS), USDA; Angelo Gracci and Wilda Martinez with the Science and Education Administration (SEA), USDA; Kenneth Lewis and Lynn Jones with the National Cottonseed Products Association; Robert Bethea, Henry Foster, and Abraham Seidman with Texas Tech University; and numerous individuals working in the cottonseed processing industry. Financial support was received from SEA and ESS, USDA, and from Texas Tech University.

TABLE OF CONTENTS

	<u>Page</u>
INTRODUCTION	1
COTTONSEED OIL MILL DESCRIPTION AND DESIGN	2
MODEL DESCRIPTION	12
General Mill Specification	13
Cost and Revenue Input Data Requirements	15
Capital Asset Items	15
Non-depreciable Fixed Costs	17
Revenue Data	17
Variable Cost Data	18
EXAMPLE MODEL RUN	24
Fixed Cost Input Data	26
Revenue Input Data	27
Variable Cost Data	29
Specific Variable Cost Item Data	31
Computer Output	34
LIMITATIONS	37
LIST OF REFERENCES	38
Appendix I. Computer Program Variable Names and Explanations.	39
Appendix II. Main Program and Subroutines Flows Diagrams	50
Appendix III. Input Variable Names, Explanations, and Card Format	57
Appendix IV. Input Data Cards Arrangement	65
Appendix V. Card Deck Arrangement	67
Appendix VI. The Computer Program	69
Appendix VII. Computer Model Output From the Example Data Set	77

COTTONSEED OIL MILL SIMULATION MODEL:
DOCUMENTATION AND USER'S GUIDE

Billy R. Hise¹

INTRODUCTION

The cottonseed oil mill industry in the U.S. has experienced large changes in recent years in terms of location, size, and number of operating mills; e.g., there was a decline from 188 mills in 1963 to 83 mills in 1977 (7, p. 2).² In part these changes can be attributed to a decline in cotton production in the Southeast where a large number of smaller capacity mills were located and an increase in cotton production in the West where newer, large capacity mills were built as production shifted West (8, p. 3). While these changes may be somewhat stabilized, the industry is presently faced with new economic and technological questions which must be addressed on an individual mill basis and/or on an industry-wide basis. Increasing cost of equipment, labor, electricity, fuel, and hexane combined with low product prices (particularly hulls and linters) in some years, have caused mills to examine processing alternatives (3; 7). With the recent concern about cotton dust in all segments of the cotton industry, the cottonseed oil mill industry will need improved or new technologies to reduce dust levels in the mills. There are also regional problems (aflatoxin) and individual mill problems (increasing mill capacity, replacing equipment, etc.) which must be examined.

¹ The author is a Research Associate, Department of Agricultural Economics, Texas Tech University.

² Numbers in parenthesis refer to the corresponding number in the List of References.

One method of analyzing questions of this type is the use of computerized simulation models developed for specific types of operations (6; 10). This report presents the documentation of a computerized simulation model developed for simulating the costs and returns for actual or hypothetical cottonseed oil mills. Particular emphasis is placed on developing a data set for use in the computer program.

In terms of organization of the report, the first section presents a general description of a cottonseed oil mill and is followed by a more specific discussion of individual cost centers or processing steps needed to accomplish cottonseed oil extraction. The next section defines the simulation model structure and specific input data needed. The last section discusses an example data set and the computer output based on the data set.

The appendices were developed for those readers interested in more technical details of the model. Included are: a list of computer program variable names and explanations; flow diagrams of the computer program logic; explanation of input data arrangement on cards; input data card deck arrangement; card deck arrangement including the program, data, and job control cards; listing of the computer program Fortran statements; and the results of a computer run using the example data set.

COTTONSEED OIL MILL DESCRIPTION AND DESIGN

This section is designed for those users who are not familiar with oil mill operations and is only a guideline of what might be found in a "typical" oil mill operation. For a more specific description of production processes and technical information about machinery and equipment used in processing cottonseed, the reader is referred to Bailey (1) and Brewster (2).

Cottonseed oil mills process raw cottonseed into four products: oil (16-18%),³ meal (46-48%), hulls (18-26%), and linters (8-11%) (4, p. 195). An oil mill may pelletize meal, have mixed feed operations, or refine the oil. The computer program does have the ability to estimate the costs of these operations. However, for this report in both the oil mill description and the example data set, the mills discussed are assumed to produce press oil or once-refined oil (depending on the extraction technology), bulk meal, bulk hulls, and baled linters.

A typical method of describing a cottonseed oil mill is its average daily processing capacity and the type of extraction technology used. Thus, a 300 ton-per-day (TPD) solvent mill refers to a mill which averages 300 TPD of cottonseed processed and uses direct solvent oil extraction. The processing capacity for a 24 hours per day processing operation is an average tonnage; it may vary from day to day due to seed quality, mechanical problems, and other factors. Individual mill processing capacities at present range from 50 to 1,200 TPD (7, p. 2), and three extraction methods, (screwpress, pre-press solvent, and direct solvent) are used.

The typical oil mill tends to process seed on a 24-hours per day, 7 days per week basis throughout the season except for those periods when major breakdowns occur. This 24-hour per day operating period will begin when the mill has received enough seed to process at its daily rate and average daily seed receipts are equal to or greater than daily crush. Maintenance and repairs cannot be performed properly on machinery when the mill operates at this rate, and some period for repairs, maintenance, and

³ The number in parenthesis are typical product percentages by weight from raw cottonseed.

cleanup between processing years is needed. The maximum capacity utilization of the mill is the maximum number of days the mill can process seed (or 365 days less the days necessary for major breakdown repairs during the season and less the days needed for repairs, maintenance and cleanup between processing years) times the average daily processing rate. As a standard, the industry generally accepts that a mill will seldom operate more than 330 days per year.⁴ Within this maximum physical plant capacity, the determining factor on the annual production is the amount of seed available for processing.

Each mill in the industry is unique in terms of plant design and individual machinery items. However, the basic processes which must be performed on the seed to separate oil, meal, hulls, and linters can be defined with some degree of continuity among all mills in the industry.

In this report, a cost center is defined as a process or activity which constitutes an identifiable cost unit in the operation of a mill. Thus, production support items including office, seed receiving and storage, and product storage are cost centers even though they are not directly associated with the technical production processes of delinting, baling, hulling, or extraction. Therefore, a typical oil mill has more cost centers than actual processing steps needed to process cottonseed.

The oil mill cost centers presented in Figure 1 and discussed in the following sections show the flow of cottonseed through the mill. The product storage cost centers are discussed after the processing cost centers with a note as to when they are removed from the processing stream.

⁴ This average processing period is based on information gained through personal interview with various operating oil mills.

Figure 1. Flow of Cottonseed and Products Through the Cost Centers of a Typical Oil Mill

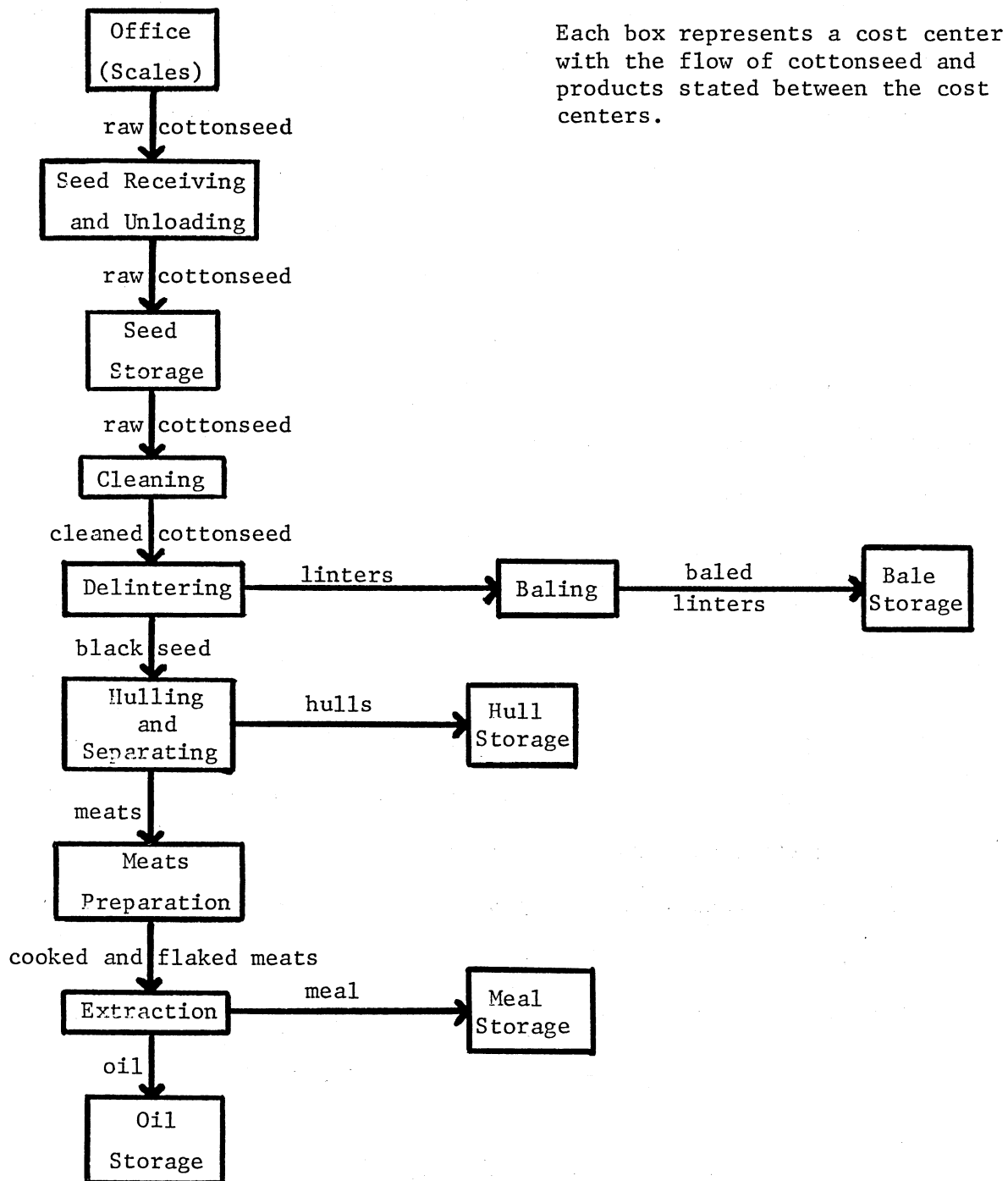

Office

Included in this cost center are the fixed costs of office buildings and equipment; the fixed labor costs of management, secretaries, and other office personnel; fixed costs for liability and business interruption insurance; and variable office operating costs such as telephones, office supplies, and temporary scale operator during the seed receiving period. The office may also include other costs which are not directly related to specific cost centers; these might include land costs, brokerage fees, and other administrative expenses.

Mills may contract outside laboratories to determine the grade basis of the raw seed received. However, other functions may be performed at laboratory facilities located at the mill, and a laboratory cost center included. Mills without a laboratory cost center assign costs of determining the grade basis of seed and other contracted laboratory expenses to the office or other cost centers.

Seed Receiving

Seed receiving is the first cost center which deals directly with the handling of cottonseed. The seed receiving period is usually tied to the local and regional cotton harvesting and ginning season. However, some mills buy seed or transfer seed from outside the local or regional area in which they are located. In either case, the variable costs associated with this cost center are based on a shorter time period than the other mill cost centers.

A common unloading facility is a hydraulic truck dump which can lift an entire tractor-trailer truck loaded with cottonseed. The cottonseed is dumped into a pit and carried through an elevator system and screwtype

conveying system to the seed storage area. In some portions of California, side dump trailers are used.

Cottonseed Storage

The types of storage facilities and the associated costs of the facilities varies from region to region due basically to the amount of rainfall during the year. In areas of high rainfall, cottonseed must be stored inside to prevent moisture damage. The typical facility is a cottonseed warehouse designed specifically for storing cottonseed. In more arid regions of the U.S., cottonseed can be stored outside. To prevent moisture penetration, these stacks of seed may be packed and in more humid areas seed may be covered with water resistant material.

In addition to costs associated with the storage facilities, a major cost of seed storage is electricity for aeration of seed which is accomplished by large fans and wind tunnels through the seed stacks or warehouses. The amount of aeration depends on the seed, the area, the length of storage, and the type of storage facility used.

Cleaning

The first actual processing stage within the cottonseed oil mill is cleaning. This step removes dirt, rocks, plant stems, and other foreign matter from the seed. The most common cleaning machine is a cleaning shaker which may have two to four trays depending on the size of the machine. The cottonseed are passed through the machine and foreign matter is screened out. Another cleaning machine, a boll reel, is used in some mills before the seed are cleaned in the shakers.

Cleaning prior to delinting and hulling help to lengthen saw blade life in delinting machines and knife life in hulling machines. Also,

foreign matter removal facilitates the movement of the seed through the remaining machinery. The major variable cost items in this processing step are electricity, labor, and repairs.

Delinting

Delinting is a general term given to the removal of linters (short cotton fibers remaining on seed from the ginning process) from the seed. Delinting can be accomplished by various methods.⁵ One method is saw delinting which uses a machine which has a series of saws which cut or tear the linters from the seed. Two or more separate cuts of linters are usually made; the seed pass through a separate delinting machine for each cut. Mills usually delinter to a point where 3-4 percent lint remains on the seed. Each delinting machine has a small hourly capacity so the delinting center has a high fixed cost and large electrical energy use.

Delinting saws must be sharpened (typically once every 24-hours) which involves removing the cylinder holding the saws (176 saws on a cylinder in a new machine) from the delinting machine and placing it in a gummer machine for sharpening. After the saws are sharpened, the cylinder must be replaced in the delinter. This activity incurs substantial labor and repair costs.

The delinters and gummers are not the only machinery needed in the delinting process, but account for a large portion of its costs. The linters are run through lint beaters and pneumatically conveyed to the baling area. The black seed (seed with linters removed) move on to the hulling and separating stage.

⁵ For further information on alternative technologies of delinting cottonseed, read Clark (3) or Hise and Ethridge (7)

Baling

After delinting, linters are packaged for handling, grading, and marketing. The linters are typically compressed into bales and are packaged with bagging and ties (in most mills) the same way cotton lint is baled at gins. Because there are separate uses and therefore separate markets for different cuts of linters, the various cuts of linters are typically baled separately. This cost center is more labor intensive than some other portions of the mill and uses less electrical energy. The linters are moved from baling directly to bale storage, which will be discussed subsequent to the remaining processing steps.

Hulling and Separating

The black seed move directly from delinting to the huller room. Most mills use a magnet to remove metal objects that may have entered the seed flow; some mills have another small cleaning shaker to remove foreign materials before hulling. This step increases the life of the knives in the hullers. The seed enter the huller and the hulls are cracked by the knives. The amount of oil absorption by the hulls is affected by huller performance. The cracked seed are passed over a 2-tray shaker separator which allows the oil bearing meats to fall through to the bottom tray with the hulls remaining on the top tray. This, however, is not a final separation--some seed do not get cracked and remain with the hulls, some of the meats are not separated and remain in the hulls, and some hulls fall through with the meats. Thus, additional machinery such as hull beaters (which separate uncracked seed from hulls), meat purifiers (which separate hull fragments from meats to control protein level of meal), and tailings beaters are needed. The uncracked seed re-enter the huller. The hulls are

removed to hull storage facilities, and meats continue in the mill to the meats preparation stage.

Machinery and conveying equipment used in this cost center require a sizable amount of electricity and repair costs in comparison with other portions of the mill. However, the hulling and separating step does not have a large labor requirement.

Meats Preparation

After the final separation of hulls and hull fragments from meats, the meats are conveyed to the meats preparation processing step. In this step meats are treated with steam to prepare them to be flaked by a flaking roll. This is the first portion of the mill to use steam. Consequently, this cost center will incur some of the cost of boiler fuel and water as well as variable costs of labor, electricity, and repairs.

Extraction

There are three methods of extracting oil from meats--screwpress, solvent, and pre-press solvent extraction. Screwpress extraction is accomplished by a mechanical application of pressure to the cooked flakes to squeeze out the oil. The screwpresses are powered by large electric motors causing this type of extraction to be a heavier user of electrical power. The cost of the machinery also gives this type of extraction a high fixed cost in terms of TPD capacity per machine.

Direct solvent extraction is accomplished by a chemical process in which the flaked meats are saturated with a solvent (hexane). The oil combines with the solvent to remove it from the meats. The hexane is separated from the oil by a distillation process and the hexane is then reused. However, there is some hexane loss in the process.

The pre-press solvent method of extraction is a combination of screw-press extraction and solvent extraction. A portion of the oil is extracted by screwpress, but at a lower level of pressure and a faster rate than by the screwpress method alone. The remaining oil is extracted by the solvent method. Approximate percentages of oil left in the meal are four, one, and less than one for screwpress, direct solvent, and pre-press solvent methods, respectively.

Following extraction the meal is cooled, ground and placed in storage. Oil extracted by the solvent method is partially refined before storage. In pre-press solvent mills, the partially refined oil is mixed with the press oil for storage. Screwpress extracted oil needs no refining before it is stored.

Oil Storage

Oil is stored in cylindrical, steel storage tanks, which makes the major oil storage costs fixed. Small amounts of electrical energy and labor are required to pump the oil to tank cars or trucks. Another cost of oil storage is product insurance, which is based on the average amount of oil in storage over the twelve month period.

Meal Storage

Meal requires inside storage; thus, a major portion of this cost of storage is fixed. Loading of meal is accomplished a number of ways, mechanical conveying and front-end loaders are most common. The energy or fuel and labor requirements for meal loading are typically higher than for oil loading. As with oil storage, product insurance is a major cost.

Hull Storage

Hull storage facilities vary greatly from mill to mill. Some mills in arid regions use open storage for hulls. The area required to store a ton of hulls is greater than meal because of the relative compactness of meal. Hull storage may have a high fixed cost associated with it, depending on the facilities used. Loading is accomplished by the same methods as meal. Because hulls do not have a high per unit value, the product insurance cost is not as high for hulls as for oil and meal.

Linter Storage

Most mills use forklifts for handling bales from the press area to the bale storage area which is usually located in the same building. The same employees which operate the bale presses may also supply labor for this cost center. Again, the per unit value of linters makes the cost of insuring them small compared to insurance cost of oil and meal.

MODEL DESCRIPTION

The cottonseed oil mill simulation model is a computerized model for estimating the cost and returns from processing cottonseed. The model can be defined as a set of mathematical relationships based on economic and engineering concepts within the framework of typical oil mill practices from which estimated costs and returns of processing cottonseed may be calculated. A flow diagram of the computer program logic and a listing of the Fortran statements of the computer model program are shown in Appendices II and VI, respectively.

The cottonseed oil mill industry consists of mills operating at different TPD capacity rates, in different regions of the U.S., with different extraction technologies, and under differing managerial practices. This

leads to the development of a system which defines those relationships which are common to all mill situations. However, to maintain enough flexibility to accurately estimate the costs and returns of a wide range of cottonseed oil mill situations (actual or hypothesized), the simulation model is designed and programmed with many input variables allowing the user to develop the technical coefficients required for a specific mill situation. Definitions of variables and their use as input data follows.

General Mill Specification

The exact division of a mill into cost centers and placement of costs and technical information on buildings, machinery, equipment, and resource inputs into these cost centers can vary among mills. This simulation model gives the user the ability to determine the cost centers to be modeled according to the following procedure. The production support cost centers of OFFICE, SEED UNLOADING, SEED STORAGE, OIL STORAGE, MEAL STORAGE, HULL STORAGE, and LINTER STORAGE can be selected by placing 1's in appropriate columns on the first data card (card 1, Appendix III). The remaining cost centers are the actual processing steps of the mill and can vary from mill to mill. Therefore, the number of these cost centers which will be included in the specific mill situation being modeled must be specified on the first data card (columns 6-8). Also, included on this card are the geographic area and the extraction technology of the mill situation specified (columns 1 and 2).

Costs and returns are based on specific time periods which are input data to the model. The times which must be specified are; (1) days processing, (2) days for major break-downs and repairs between processing years, and (3) days for seed receiving (card 2, Appendix III). The computer model

develops costs and returns at 10 utilization levels from 100% to 10% by 10% decrements. For example, a mill operating 330 days at 100% utilization, will process 297 days at 90%, down to 33 days at 10% utilization. The model also requires the average daily processing rate as input data (card 2). The average daily processing rate times the number of days processing determines the tons of seed processed at each utilization level. Using the processing days at 330 and an average processing rate of 100 TPD, the mill will process 33,000 tons at 100% utilization, 29,700 tons at 90%, down to 3,300 tons at 10%.

To determine the cost of seed at each level of utilization, an average cost per ton of seed received, including the cost of transporting the seed to the mill, is needed (card 2, Appendix III). This value times the capacity utilization level in tons of seed yields the cost of cottonseed (excluding interest on operating capital) at each utilization level. The interest on operating capital for seed is determined by the formula in the Fortran statement number 59 of the MAIN program in Appendix VI⁶ where the short term interest rate (RS) is included as input data on card 2, Appendix III.

The two remaining variables on card 2, Appendix III are the interest rate on long term capital and the average period of time in weeks from processing to sales of products. These variables are used to determine specific costs and are discussed when they are used by the computer model.

The computer model generates the following costs and returns of a mill situation: (1) the cottonseed oil mill description (Section A)⁷;

⁶ The variable names and definitions of the variables are shown in Appendix I.

⁷ The sections (in parentheses) refer to the divisions of the computer output the example mill data set in Appendix VII.

(2) fixed costs by item totaled by cost center and summed for the entire mill (Section B); (3) total revenue at 100% capacity utilization (Section C); (4) total variable costs by item, totaled by cost center, and summed for the entire mill at all levels of capacity utilization (Section D); (5) the associated average variable costs by item, totaled by cost center, and summed for the entire mill at all levels of capacity utilization (Section E); (6) average cost per ton of seed processed of ten specific resource items (labor, electricity, repairs, lab analysis, bagging and ties, fuel, miscellaneous, solvent, insurance, and water) at all levels of capacity utilization (Section F); (7) average fixed cost by cost center at all levels of capacity utilization (Section G); (8) average variable cost by cost center at all levels of capacity utilization (Section I); (10) total costs and returns of the entire mill at all levels of capacity utilization (Section J); and (11) average costs and returns for the entire mill at all levels of capacity utilization (Section K). The computer model is programmed to print each of these sections automatically with the exception of sections D, E, and F. To have these sections printed, the users must place 1's in the appropriate columns of the control card (column 15, 18, and 21, respectively, card 1, Appendix III).

Cost and Revenue Input Data Requirements

The following sections discuss the data input requirements for developing cost and returns for a mill situation. These data will be discussed in the order in which they must be input: (1) fixed cost data, (2) revenue data, and (3) variable cost data.

Capital Asset Items

The fixed ownership cost for each capital asset items includes the

costs of depreciation, interest, taxes, insurance, and fixed repairs. For each capital asset item, the computer model requires the FOB cost, the number needed, the transportation and installation⁸ rate [expressed as a fraction of FOB cost (4, pp. 110-113)], a fixed repair rate as a fraction of FOB cost, estimated years of useful life, and salvage value as a fraction of FOB cost are also required input data (cards 5 and 6, Appendix III).⁹

Depreciation is the cost of ownership due to wear and/or obsolescence and is calculated by the straight line depreciation method. Interest cost may represent the opportunity cost or revenue lost by not using the funds invested in the capital asset items in their next best alternative use. The simulation model uses a formula which calculates both interest and depreciation (Fortran Statement No. 70, in Subroutine FIX(TFC), Appendix VI) using the interest rate on long term capital previously discussed.

Taxes and insurance are based on the total cost of obtaining and installing each capital asset item. A tax rate per \$100 of capital asset value and an insurance rate \$1,000 of capital asset value are placed in the data set following the format of card 3, Appendix III. The annual equivalency cost (total fixed cost of the item) is the sum of depreciation, interest, fixed repair costs, taxes, and insurance (Section B, Appendix VII).

A special case is made for land, which is a non-depreciable, non-insurable capital asset item. Land is subject to the long term interest rate for developing interest cost and is taxable. The data requirements closely fit the other capital asset items so the only change in input

⁸ This installation cost may include piping, concrete, electrical, instrumentation, paint, engineering, labor, etc.

⁹ The reader may find it useful to refer to Appendix IV simultaneously with reference to Appendix III.

format from card 6, Appendix III is the identification character in column 1 (card 5, Appendix III). This identification specifies that insurance and depreciation will not be calculated on land.

Non-depreciable Fixed Costs

The costs of specific items which are non-depreciable, non-taxable, non-insurable, and have no fixed repair cost but will remain the same regardless of the level of production are classified as non-depreciable fixed costs. The cost of these items includes the annual outlay cost plus an interest cost (which reflects the opportunity cost). Because these items are not purchased on a long term basis, the short term interest rate is used in determining the interest cost of the item (Fortran statement 97, Subroutine FIX(TFC), Appendix VI).

The fixed labor component of a typical mill includes those employees which are salaried full time employees. Certain job classifications which may be in this group are: mill manager, assistant manager, sales staff, secretaries and bookkeepers, mill superintendents, engineers, shift supervisors, foremen, and laboratory employees. The majority of the fixed labor can be included in the office cost center due to the difficulty of allocating to other cost centers. Other fixed costs may include special insurance costs--such as business interruption--or special cost items which do not depend on the level of annual utilization such as office supplies, dues, subscriptions, audit, legal, and other administrative expenses.

Revenue Data

The average amount of oil, meal, hulls, and linters (where linters may be entered by specific cuts) produced from a ton of seed and the average prices received for these products are required input data

(cards 9-13, Appendix III). Each product produced must be entered as average pounds produced from one ton of cottonseed. However, product prices are entered as: (1) cents per pound for oil, (2) dollars per ton for meal, (3) dollars per ton for hulls, and (4) cents per pound for linters. The control character in column 1 determines which product is specified. If the control character is 0, the product is oil; M, the product is meal; H, the product is hulls; and L, the product is linters. These data are used by the computer in Subroutine NR(TR) to generate total revenue by each product and total revenue at 100% capacity utilization. The model then uses these values to generate total revenue of the mill at each level of capacity utilization based on the amount of seed processed. Because average prices and production relationships are used for the entire period, average revenue is the same at all capacity utilization levels.

Variable Cost Data

Resources which vary directly (but not necessarily proportionally) with the level of capacity utilization are termed variable resources. Physical and cost relationships of these items at the 100% capacity utilization level are entered in the data set by cost centers. Computational procedures to develop input requirements and cost at the nine other utilization levels are programmed into the computer model for each specific cost item. Each of the eleven variable cost items are discussed below.

Labor: Variable mill labor consists of employees who are on an hourly wage rate and whose hours worked vary with the level of mill utilization. The total year can be divided into three time periods: (1) actual seed processing, (2) repair and maintenance between seasons, and (3) dormancy between

processing years. An employee may be hired for one, two, or all three periods. If an employee is hired for all three periods the annual cost of the employee becomes fixed and can be included either as a non-depreciable fixed cost data input item or in the variable cost specification just described, depending on the user's discretion.

The typical oil mill operates three eight hour work shifts seven days per week. To alleviate overtime pay some mills have relief crews or a fourth shift which rotates with various shifts during a work week resulting in a 40 to 48 hour work week for most employees. Due to the variability of work schedules among and within mills, the computer model was not programmed to develop labor costs based on an hourly wage rate. The model does determine the number of weeks each employee works (in each of the three periods discussed) at each level of capacity utilization. Employees within a cost center which earn the same weekly wage can be grouped in the data set by entering the number of employees for each time period and the weekly wage rate, including allowances for all benefits (card 20, Appendix III). The number of cards required to include all variable labor within a cost center will be the number of wage groups within the cost center, not the number of employees.

Electricity: The major source of power in a cottonseed oil mill is electricity. Connected electric motor horsepower is user specified by machinery item as part of the fixed cost input data (card 6, Appendix III). The connected horsepower is totaled by cost center and converted to kilowatt hours based on the average number of hours per day the machinery in each cost center operates over the processing period [TIME(K), card 15, Appendix III] by the formula in Fortran statement 139, Main Program, Appendix VI. This

time variable must be input for the production support cost centers of unloading, seed storage, and product storage. The time variables used in these cost centers should reflect the average period of time to unload one truck in the unloading cost center and the average daily hours of machinery use for removing products from storage in the storage cost centers. In the unloading cost center, the user must also specify the number of unloading facilities for the mill and the average truck size (in tons) of trucks unloading at the mill (card 16, Appendix III). These variables are used to determine electrical energy usage by the unloading facilities (Fortran Statements 100 and 101, Main Program, Appendix VI). A default value of 24 hours is used if the user does not specify the time variable. Total kilowatt hours per year is the daily consumption times the annual days of operation at each utilization level.

There is a wide variation in the rate structures of electrical power companies serving cottonseed oil mills. All rate structures contain a cost per kilowatt hour consumed and a monthly or annual demand or service cost when no power is used. Therefore, electricity costs are based on a user supplied average cost per kilowatt hour and a monthly charge when the mill is not operating (card 14, Appendix III).

In the dormant period electricity cost is allocated to each cost center as a percentage of that cost center's connected horsepower to total mill connected horsepower.

Variable Repairs: Many factors affect the cost of variable repairs in a cottonseed oil mill. The two major factors are age of the mill equipment and the condition of the seed processed through the mill. These two factors can vary greatly within a region as well as from region to region.

The simulation model requires a user supplied variable repair cost per ton of seed processed for the entire mill as input data (card 14, Appendix III).

Repair cost per cost center usually depends on the amount of machinery within that cost center. One indicator of the amount of machinery in a cost center is the total connected horsepower of that cost center. The computer model divides the total mill variable repair cost among the cost centers based on the ratio of cost center connected horsepower to total mill connected horsepower.

Water: The amount of water used by a specific machinery or equipment item is included in the data set in the fixed cost section of the computer model. Water use is expressed in terms of 1,000 gallons per ton of cottonseed processed. Similiar to electricity, water costs are supplied by the user as a water rate per 1,000 gallons and a monthly charge when no water is used (card 14, Appendix III). The total water cost is developed at each level of capacity utilization (Fortran Statement 57, Appendix VI) and allocated to cost centers based on the ratio of cost center water usage to total mill water usage.

Fuel: The type of fuel used to operate the boiler tends to vary from region to region depending on the availability and costs. In the Southwest and West, the more common boiler fuel is natural gas. In the South, fuel oil is the common boiler fuel. Because these differences in fuel types exist, the model is designed to use a rate of fuel consumption per ton of seed processed and a price per unit of fuel as user supplied input data (card 16, Appendix III). These data must be entered by cost center and more than one fuel rate and price can be entered on separate data cards if necessary. The cost of fuel is developed by cost center and by utilization

level according to the formulas in Fortran Statements 43, Subroutine STAGE and 141, Main Program, Appendix VI.

Bagging and Ties: To develop the cost of bagging and ties, the amount of linters produced per ton of seed processed and the average price paid per pattern are supplied by the user (card 16, Appendix III). The amount of linters produced can be entered by cut (up to 3 cuts including notes) or as a total of all cuts combined.

Total linters production at each utilization level is the pounds produced per ton of seed times the tons of seed processed at each utilization level. To determine the number of bagging and tie patterns needed, the total linter production is divided by 600 pounds, the standard size bale for the industry. This value times the price per pattern yields total cost of bagging and ties (Fortran Statements 41, Subroutine STAGE and 145, Main Program, Appendix VI).

Hexane: At pre-press and direct solvent mills, the cost of hexane is of major importance in the extraction cost center. The hexane loss varies from mill to mill but usually ranges around one gallon per ton of seed processed. Because of this variation, the user must supply the hexane loss per ton of seed processed as input data along with the average price paid per gallon for hexane (card 16, Appendix III). The hexane cost is developed for each utilization level by multiplying the cost per gallon times the amount of seed processed (Fortran Statements 45, Subroutine STAGE and 147, Main Program).

Lab Analysis: The lab analysis to determine the grade basis of seed received by the mill is assumed to be contracted at a specific cost per ton. This value must be supplied by the user (card 16, Appendix III). To

determine total cost of lab analysis, this value is multiplied times the number of tons of seed processed at each utilization level (Fortran Statement 86, Main Program, Appendix VI).

Insurance: Cottonseed and product insurance costs are based on the average amounts and values of cottonseed and/or products held in storage during a one year period (Fortran Statements 122, 180, 198, 216, and 234, Main Program, Appendix VI). The insurance rate is user input as a dollar cost per \$1,000 value of products held on the average throughout the year (card 14, Appendix III). The simulation model determines values based on the average prices for cottonseed and products which have previously been inserted in the data set.

Interest: The short term interest rate (previously discussed) and the average period of time (in weeks) from processing to sales of products are user input data needed to calculate the opportunity cost associated with using short term capital to purchase the resources for processing cottonseed (card 2, Appendix III). The interest on operating capital (opportunity cost) is calculated by cost center at each level of capacity utilization based on total amount of variable cost for all resources used within a particular cost center (Fortran Statement 88, Main Program, Appendix VI).

Miscellaneous: A special category is needed for all variable costs which are not included in the standard costs listed above. Miscellaneous costs per ton of seed processed is required user input data (card 16, Appendix III). Miscellaneous costs per ton of seed processed can be specified to applicable cost centers by the user. Costs which may fall into this category are costs of brokerage fees for sales of products, maintenance cost of items not included in the repair costs, legal fees, dues, etc.

EXAMPLE MODEL RUN

This section discusses the data requirements, input format, and data card deck arrangement for a hypothetical mill situation. A listing of the example mill actual data cards are contained in Figures 2, 3, and 4 with explanatory headings and titles added. Additional descriptions, variable names, explanations of each variable input, and card deck arrangement are contained in Appendices III and IV. The data set used in this example is for a hypothetical mill situation and is intended to illustrate the use of the computer model program; the data do not represent an actual or typical mill.

The first data card (Figure 2) defines the mill situation by area, extraction technology, and the cost centers which are included in columns 1-12. The 1 in column 1 indicates the example mill is located in the South. The 1 in column 2 indicates the mill uses screwpress extraction. The 1's in columns 3-5 show that OFFICE (card 4), UNLOADING (card 12), and COTTONSEED STORAGE (card 15), are to be included as cost centers in this model run. The 6 in column 8 shows there are 6 mill cost centers which are actual processing steps. These are CLEANING (card 18), DELINTERING (card 22), BALING (card 31), HULLING-SEPARATING (card 33), MEATS PREPARATION (card 45), and EXTRACTION (card 51). The 1's in columns 9-12 show that OIL STORAGE (card 57), MEAL STORAGE (card 60), HULL STORAGE (card 62), and LINTER STORAGE (card 64) are included as cost centers in this run. The 1 in column 15 tells the computer to print total variable cost by item by cost center and total for the entire mill at all levels of capacity utilization (Section D, Appendix VII). The 1 in column 18 tells the computer to print average variable cost by item, by cost center, and total for the entire mill at all levels of capacity utilization

FIGURE 2. CONTROL, DESCRIPTIVE, AND FIXED COST DATA

CARD NO. CONTROL DATA

1. 11111 61111 1 1 1
 10 20 30 40 50 60 70
 123456789-123456789-123456789-123456789-123456789-123456789-123456789-COL.NOS.

CAP. DAYS DAYS DAYS COST OF LONG SHORT
 PLANT PROC REP UNLD SEED TERM TERM WEEKS
 2. 100 330 35 120 118.88 .15 .10 4.
 10 20 30 40 50 60 70
 123456789-123456789-123456789-123456789-123456789-123456789-123456789-COL.NOS.

TAX INS.
 RATE RATE
 3. 1.4 6.
 10 20 30 40 50 60 70
 123456789-123456789-123456789-123456789-123456789-123456789-123456789-COL.NOS.

ID	NAME(I)	FOB COST	NUM	YR	INST	REP	SAL VALUE	CON HP	WATER
4.	LOFFICE								
5.	ALAND	1000	5	50			1		
6.	FBUILDING	26.80	1500	40	0	.01	.1	0	0
7.	CMILL MANAGER	25000	1						
8.	CMILL SUPT.	22000	1						
9.	CSHIFT SUPV.	18000	3						
10.	CFOREMEN	16000	6						
11.	CSECRETARIES	7500	1						

10 20 30 40 50 60 70
 123456789-123456789-123456789-123456789-123456789-123456789-123456789-COL.NOS.

DATA FOR EACH COST CENTER ENTERED BY FORMAT FOR CARDS 4-11

12.	LUNLOADING								
13.	FSCALES	18852	1	30	1.45	.01	.1	0	0
14.	FTRUCKDUMP	56877	1	25	1.45	.01	.1	50	0
15.	LSTORAGE								
16.	FSEEDHOUSE	465750	2	40	0	.02	.1	100	0
17.	FCONVEYORS	18880	1	20	1.45	0	0	50	0
18.	LCLEANING								
19.	FBUILDING	13.5	900	40	0	.01	.2	0	0
20.	F2-TRAY SHAKERS	29375	2	30	1.31	0	0	30	0
21.	FCONVEYORS	4720	1	20	1.45	0	0	20	0
22.	LDELINTERING								
23.	FBUILDING	13.5	3000	40	0	.01	.2	0	0
24.	FDELINTERS	14582	14	30	1.31	0	0	420	0
25.	FGUMMER	15845	1	30	.76	0	0	2	0
26.	FLINT FLUE SYS	2500	1	20	1.45	.02	0	60	0
27.	FLINT ROBBING SYS	3500	1	20	1.45	.02	0	6	0
28.	FLINT PICKUP SYS	3000	1	20	1.45	.02	0	6	0
29.	FLINT CLEANER	24744	2	30	1.31	0	0	10	0
30.	FCONVEYORS	11060	1	20	1.45	.02	0	20	0
31.	LBALING								
32.	FBUILDING	12.8	200	40	0	.01	.2	0	0
33.	FBALE PRESS	121713	1	40	1.31	0	0	75	0
34.	LHULL-SEP								
35.	FSAFETY SHAKER	8378	1	20	1.31	0	0	10	0
36.	FHULLER	14993	2	25	1.31	0	0	0	0
37.	FPURIFYING-HULLER	7383	2	25	1.31	0	0	0	0
38.	FDOUBLE DRUM BEATER	13230	1	25	1.31	0	0	0	0
39.	FH AND S MACHINE	7378	1	25	1.31	0	0	0	0
40.	FMEATS PURIFIER	11793	1	25	1.31	0	0	0	0
41.	FTAILINGS BEATER	7545	1	25	1.31	0	0	0	0
42.	FMOTES BEATER	5395	1	25	1.31	0	0	0	0
43.	FCONVEYORS	1260	1	15	1.31	0	0	0	0
44.	FHULLS BLOWING SYS	10100	1	15	1.31	0	0	0	0
45.	LMEATS PREPARATION								
46.	FMEATS COND. BLDG.	13.50	600	40	0	.01	.2	0	0
47.	FBOILER	22700	1	30	1.31	0	0	0	0
48.	FCRUSHING ROLLS	95040	1	30	1.31	0	0	0	0
49.	F6-HIGH COOKER	128400	1	30	1.31	0	0	0	0
50.	FCONVEYORS	8873	1	15	1.31	0	0	0	0
51.	LEXTRACTION								
52.	FSCREWPRESS	139030	2	40	1.45	0	0	300	100
53.	FBUCKET ELEV.	5300	1	20	1.45	.01	0	2	0
54.	FSETTLING TANK	18000	1	20	1.31	.01	0	5	50
55.	FFILTER PRESS	25450	1	30	1.31	0	0	6	20
56.	FPUMP-CONVEYORS	11850	1	15	1.45	.01	0	10	10
57.	LOIL STORAGE								
58.	FTANKS	12000	3	25	1.31	.01	.1	0	0
59.	FPUMPS	3300	1	10	1.31	0	0	20	0
60.	LMEAL STORAGE								
61.	FBUILDING	13.2	3150	40	0	.01	.1	20	0
62.	LHULL STORAGE								
63.	FBUILDING	13.2	7800	40	0	.01	.1	30	0
64.	LLINTER STORAGE								
65.	FBUILDING	13.2	3000	40	0	.01	.1	5	0
66.	END								

10 20 30 40 50 60 70
 123456789-123456789-123456789-123456789-123456789-123456789-123456789-COL.NOS.

(Section E, Appendix VII). The 1 in column 21 tells the computer to sum the average variable cost items: labor, electricity, repairs, lab analysis, bagging and ties, fuel, miscellaneous, solvent, insurance, and water for the entire mill at each level of capacity utilization and print those costs (Section F, Appendix VII).

The second data card continues the mill descriptive data. The first variable states the average daily processing capacity of the example mill is 100 tons of cottonseed per day (cols. 3-5), for a maximum of 330 days per year (cols. 8-10), with 35 days needed for down time during the processing period and for major repairs and cleanup between seasons (cols. 14-15). The mill will receive seed for 120 days (cols. 18-20) and pay \$118.88 per ton for seed and transportation to the mill (cols. 25-30). The next two variables are the interest rate on short term capital--15 percent (cols. 33-35)--and the interest rate on long term capital investment--10 percent (cols. 38-40). The last variable on the second data card is the average period between processing and sales of products--4 weeks in the example (cols. 44-45).

The third data card contains the property tax rate for land, buildings, and equipment per \$100 value of these items--\$1.40 (cols. 3-5)--and the insurance rate per \$1,000 value of buildings and equipment--\$6.00 (cols. 9-10).

Fixed Cost Input Data

The next group of input data cards (4-66, Figure 2) provide the computer program the data to develop the fixed costs in Subroutine FIX(TFC). The identifying character (column 1) of each card tells the computer what information is on that card; an L in column 1 indicates a cost center

title will follow and no calculations are performed (Appendix III, card 4). If the card has an F in column 1, the fixed cost item is a depreciable asset, such as OFFICE BUILDING in the example data set, card 6. The input data needed for each depreciable asset item is explained in Appendix III, card 6. If the card has an A in column 1, the item is a non-insurable item (not subject to property insurance but is subject to property taxes). The input data needed is the same for these items as for depreciable fixed asset items and is shown in Appendix III, card 5. An example of a non-insurable fixed asset is land (card 5, Figure 2).

The last type of fixed cost item is one which is not subject to property taxes, non-insurable (not subject to property insurance rate), and non-depreciable. An example of this type of fixed cost item in the example mill is fixed labor such as mill manager (card 7, Figure 2). This type of fixed cost item is designated by a C in column one and is entered in the data set as shown in Appendix III, card 7.

Control card 1 shows 13 cost centers. Therefore the data set must contain 13 cost center title cards and data must be entered in their appropriate cost center. Input data can have zero values for all variables with the exception of (1) the FOB cost, (2) the number of units needed, and (3), when applicable, the years of useful life.

The last fixed cost data card (card 66) must have END in columns 1-3. This tells the computer: (1) the end of the fixed cost data has been reached; (2) sum the total fixed cost of the last cost center ; (3) sum the total fixed cost for the entire mill; and (4) return to the main program.

Revenue Input Data

The example mill revenue input data are shown in Figure 3, cards 67-72

FIGURE 3. REVENUE DATA

CARD NO.	ID	NUMBER PRODUCED	PRICE /UNIT
67.	O	319	.281
68.	M	932	143.62
69.	H	443	39.26
70.	L	140	.073
71.	L	45	.088
72.	E		

10 20 30 40 50 60 70

123456789-123456789-123456789-123456789-123456789-123456789-123456789-COL. NOS.

and the method for inputting the data is shown in Appendix III, cards 9-13. Following the data in card 67, the mill produces 319 pounds of oil per ton of seed processed (cols. 8-10) and receives an average price of 28.1¢ per pound (cols. 17-20). The remaining pounds of product produced from one ton of seed and average prices received (cards 68-71, Figure 3) are: 932 pounds of meal at \$143.62 per ton of meal, 443 pounds of hulls at \$39.26 per ton of hulls, and two cuts of linters--140 and 45 pounds at 7.3¢ and 8.8¢ per pound, respectively. The last card of the data set (card 72) has an E in column 1, which tells the computer: (1) the end of the revenue data has been reached; (2) total of the revenue generated by the products of the mill; and (3) return to the Main Program.

Variable Cost Data

The example mill variable cost data input cards are shown in Figure 4. Card 73 contains prices which are common to all cost centers. The first two variables indicate that electricity costs \$.05 per kilowatt hour (cols. 8-10) and that the minimum monthly electricity charge is \$70 (cols. 18-20), respectively. The next two variables are the cost of water: (1) \$1.50 per 1,000 gallons of water used (cols. 27-30) and (2) \$30 per month when the mill is not operating (cols. 38-40). Insurance costs \$6.00 per \$1,000-value on products in storage over the production year (cols. 49-50), and the repair cost is \$3.65 per ton of seed processed (cols. 57-60). A more detailed description of these variables is shown in Appendix III, card 14.

The variable cost data must be placed in the data set by cost centers. Just as the fixed cost data needed 13 cost center titles, the variable cost data set must contain the same 13 cost center titles (Figure 4, cards 74, 79, 84, 87, 90, 95, 99, 102, 106, 110, 113, 116, and 119)

FIGURE 4. VARIABLE COST DATA

CARD NO.	ELECTR RATE	ELECTR MONTHLY	WATER RATE	WATER MONTHLY	INSUR RATE	VARIABLE REPAIR
73.	.05	70.	1.50	30.	6.	3.65
	10	20	30	40	50	60
	70	80	90	00	10	20

123456789-123456789-123456789-123456789-123456789-123456789-123456789-COL.NOS.

CARD NO.	TITLE(K,I)	TIME(K)
74.	OFFICE	
	10	20
	30	40
	50	60
	70	80

123456789-123456789-123456789-123456789-123456789-123456789-123456789-COL.NOS.

ID	PRICE /UNIT	NUM1	NUM2	NUM3
75.	A .25			
76.	M 1.25			
77.	M .30			
78.	E			
	10	20	30	40
	50	60	70	80

123456789-123456789-123456789-123456789-123456789-123456789-123456789-COL.NOS.

DATA FOR EACH COST CENTER ENTERED BY FORMAT FOR CARDS 74-78

79.	UNLOADING		.40		
80.	L 250.	3.			
81.	U	1.			
82.	T	20.			
83.	E				
84.	SEED STORAGE		3.		
85.	L 250.	3.			
86.	E				
87.	CLEANING				
88.	L 300.	1.5			
89.	E				
90.	DELINTERING				
91.	L 275.	3.	3.		
92.	L 350.	3.	3.	3.	
93.	M .3				
94.	E				
95.	BALING				
96.	L 300.	1.	1.	1.	
97.	B 2.45	140.	45.		
98.	E				
99.	HULLING-SEPARATION				
100.	L 275.	1.			
101.	E				
102.	MEATS CONDITIONING				
103.	L 275.	1.			
104.	F 1.75	2.			
105.	E				
106.	EXTRACTION				
107.	L 350.	3.	1.	1.	
108.	L 250.	3.			
109.	E				
110.	OIL STORAGE		1.		
111.	L 250.	1.			
112.	E				
113.	MEAL STORAGE		3.		
114.	L 250.	.5			
115.	E				
116.	HULL STORAGE		3.		
117.	L 250.	.5			
118.	E				
119.	LINTER STORAGE		.05		
120.	L 200.	1.			
121.	E				
122.					
123.	10	20	30	40	50
	60	70	80	90	00

123456789-123456789-123456789-123456789-123456789-123456789-123456789-COL.NOS.

arranged in card deck in the same order. Each variable cost center must also have an end card (card 17, Appendix III and Figure 4, cards 78, 83, 86, 89, 94, 98, 101, 105, 109, 112, 115, 118, and 121).

On the title card for each cost center in the variable cost data set, a space is provided for a time variable (cols. 21-30). In the example data set, this time variable is .4 hour for the unloading cost center (card 79, cols. 28-30). This is the average time required to unload one truck which carries 20 tons of cottonseed (card 82). In the cottonseed storage cost center, the average hours per day over the production period which aeration motors were operated was 3 hours per day (card 84, cols. 29-30). In the product storage cost centers, the average time required to load products for shipment (in hours per day over the production period) is input data. An example is the average hours per day required to pump oil onto tank cars or tank trucks over the production period--1 hour per day (card 110, cols. 29-30).

Specific Variable Cost Item Data

Individual variable cost items within a cost center are inputted on data cards as shown on card 16, Appendix IV. In column 1 of these data cards (example: cards 75-77, Figure 4) is a control character which tells the computer what specific cost item data will be on that card. The list of individual items and their control character which can be included in a cost center are; lab analysis (A), bagging and ties (B), fuel (F), solvent (H), labor (L), miscellaneous (M), truck size (T), and number of unloading facilities (U). The following discussion of these individual items refers to data shown in Figure 4.

Lab Analysis (identified by "A" in column 1): The data needed to include the cost of lab analysis is shown on card 75. The cost of lab

analysis in the example is \$.25 per ton of cottonseed (cols. 8-10) and is placed in the OFFICE cost center.

Bagging and Ties (identified by "B" in column 1): The data required for including the cost of bagging and ties in the BALING cost center is shown on card 97: The cost of bagging and ties is \$2.45 per pattern or per 600 pound bale. In the example, two linter cuts (140 lbs. and 45 lbs.) are produced and shown in columns 17-20 and 28-30, respectively.

Fuel (identified by "F" in column 1): The cost of fuel may be included in more than one cost center. However, the fuel in the example is boiler fuel and is only included in the meats preparation cost center (card 104). The average price paid for natural gas at the mill is \$1.75 per thousand cubic feet (cols. 7-10). Natural gas used per ton of seed processed is 2 thousand cubic feet (cols. 19-20).

Solvent (identified by "H" in column 1): The example is a screwpress mill, and no solvent is needed. The method of inputting data for a mill using solvent extraction is much like the fuel cost data. In column 1, the control character "H" would be needed. The average price paid for solvent (hexane) would be placed in columns 2-10, and the average solvent loss per ton of seed processed would be placed in columns 11-20.

Labor (identified by "L" in column 1): More than one group or job classification of employees can be specified for a cost center (cards 91 and 92) due to different wage rates or time periods for which they are employed.

The labor cost data are inputted based on the weekly wage rate for the employee(s) including wages, overtime wages, and benefits--\$250 per week (card 85, cols. 7-10). The labor data must also include the number of employees hired at this wage rate in this cost center--three employees

are hired in SEED STORAGE during the processing period (card 85, cols. 19-20).

As previously stated, labor can be hired for three time periods which comprise the total year: processing, repair, and dormancy. The labor cost in the above example was hired only for the processing period. However, on card 91, delinting labor is hired for the processing and repair periods (cols. 19-20 and cols. 29-30, respectively). For some situations, not all the employees in a certain job classification will be hired for all three periods. In the example, extraction labor (card 107) has an average weekly wage rate of \$350 (cols. 7-10) and pays three employees (cols. 19-20) when the mill is processing, but only one of these employees is hired during the repair period (cols. 29-30), and the employee is also paid during the dormant period (cols. 39-40). In the UNLOADING cost center, labor can be hired for the unloading period only and is entered as shown in card 80, columns 19-20.

Miscellaneous (identified by "M" in column 1): Miscellaneous costs may include any cost item not in this list of variable cost items. In the OFFICE cost center, the first miscellaneous cost item (card 76) represents a brokerage fee of \$1.25 per ton of seed processed (cols. 7-10). The second miscellaneous cost (card 77) represents the cost of telephone, advertising, and dues (\$.30) per ton of seed processed (cols. 8-10).

Average Truck Size (identified by "T" in column 1): To determine the amount of electrical usage in the UNLOADING cost center, the average size of trucks transporting cottonseed to the mill must be entered in the data set. For the example mill, the average size is 20 tons of cottonseed per truck and is entered on card 82, columns 18-20.

Unloading Facilities (identified by "U" in column 1): The number of unloading facilities the mill has is also an essential variable for

determining electricity costs in the UNLOADING cost center. The example mill has one unloading facility (cols. 19-20, card 81).

Computer Output

This section presents the computer output of the cottonseed oil mill simulation model with references to the computer printout shown in Appendix VII using the example mill input data set shown in Figures 2, 3, and 4. The computer output in Appendix VII has been labeled as Sections A-K for purposes of description.

Section A, Cottonseed Oil Mill Description, identifies and describes the example mill and is derived in part from the control card information. The computer writes the appropriate area (South), extraction technology (Screwpress) of the mill, daily cottonseed processing rate in tons (100 TPD), the number of days processing (330 days), and the number of days for repairs (35 days) at the 100% capacity utilization level.

The fixed costs by item, by cost center, and total for the mill are in Section B. The appropriate component costs for each item are developed and summed as shown in the ANNUAL COST column. An example of a depreciable insurable and taxable fixed cost item is BUILDING in the first cost center, OFFICE. The total fixed cost of the building is the sum of the depreciation (\$904.50), plus interest (\$3,197.24), plus fixed repair (\$402.00), plus taxes (\$562.80), plus insurance (\$241.20) for a total annual cost of \$5307.73. For a non-depreciable item, only interest cost and the yearly cost of the item (NON-DEPRECIABLE COST) are the component costs. An example of this type of cost is the salary of the MILL MANAGER in the cost center OFFICE where the interest cost (\$1,874.99) plus the non-depreciable cost (25,000.00) results in an annual cost of \$26,874.99.

The component costs for each fixed cost item and the total fixed cost are totaled for each mill cost center. Using the OFFICE cost center as an example, these costs are shown reading across the page from TOTAL COSTS at the end of the cost center. The total depreciation (\$904.50), interest (\$19,034.64), fixed repair (\$402.00), taxes (\$632.80), insurance (\$241.20), and the non-depreciable costs (\$204,500.00) when totaled equal the total annual fixed cost of the OFFICE cost center. The last line of Section B is the annual cost for each component and shows the total fixed annual cost of (\$783,309.31) for the example mill.

In Section C, the revenue generated by each product at 100% capacity utilization is shown (example: oil sales equal \$2,958,986.00). The individual products are totaled to show the total revenue of the mill (\$5,921,583.00) at the 100% capacity.

Section D of the computer output shows the total variable cost by item by cost center for each level of capacity utilization from 100% to 10%. The first three lines show the capacity utilization level in percent, the number of tons of seed processed at each utilization level, and the number of processing days at each utilization level.

In the COTTONSEED BUY cost center, the average price paid for cottonseed (plus transportation), the number of tons of cottonseed processed at each capacity utilization level, and the short term interest rate are used to determine the seed cost (e.g., \$3,923,039.00 at 100% utilization), the interest cost (\$266,014.00 at 100% utilization), and the total cost (\$4,189,053.00) of acquiring and transporting cottonseed to the mill. The remaining parts of Section D are the variable costs by cost centers. The variable costs of these 13 cost centers are reported by cost item (labor,

electricity, repairs, etc., included in the cost center) by cost center. The variable costs are totaled for the cost center (e.g., \$59,442.00 at 100% utilization in cost center OFFICE); an interest expense calculated (\$620.00); and the interest cost added to the total variable costs (\$60,062). Average variable costs by item by cost center are reported in Section E similar to the associated total variable costs in Section D.

Section F of the computer output shows the cost per ton of cottonseed processed for the ten variable resources which may be included in a mill input data set. These are the total costs for all cost centers at each level of capacity utilization. The example mill is a screwpress mill and does not include a solvent extraction processing step. Therefore, the cost of solvent per ton is zero at all utilization levels.

The next three sections (G, H, and I) summarize the previously developed cost information into matrices of average costs by cost center at each level of capacity utilization. Section G reports the average fixed costs (e.g., \$6.84 per ton of seed processed in the OFFICE cost center at 100% utilization); Section H shows the average variable cost (e.g., \$1.82 per ton of seed in the OFFICE cost center); and Section I shows average total cost (\$8.66 per ton of seed in the OFFICE cost center), which is average fixed plus average variable costs.

The last two sections (J and K) report the total and average cost and returns respectively from processing cottonseed in the example mill situation. The costs and returns are developed at each level of capacity utilization with the exception of total fixed cost (\$783,309), which are by definition the same at all levels of utilization.

In Section J, the total cost at each level of capacity utilization is total fixed cost plus total variable cost for each utilization level. Total net revenue is the total revenue less total cost at each level of capacity utilization.

LIMITATIONS

The cottonseed oil mill simulation model was developed with the goal of maintaining enough flexibility in the computer program to accurately estimate costs and returns under varying processing capacities, extraction technologies, mill designs, and regions. To maintain this flexibility, a large number of variables are required to be supplied to the program. Therefore, knowledge of cottonseed oil mills is required to effectively utilize the model. This large data requirement is the major limitation to the computer model. Unless the user(s) has a good working knowledge of cottonseed oil mills and oil mill practices, this type of simulation may prove to be very difficult. However, with reliable input data, the flexibility and detail possible with this type of model will produce accurate estimates of costs and returns. Also, once a data set has been developed, changes in price levels, product relationships, or resources required become relatively easy.

The other major limitation of the model is the use of annual average products produced—this does not allow for changes in products due to the grade basis of the cottonseed processed—and annual average product prices, which does not allow for varying market prices during the processing year. However, changing these variables for alternative computer runs can be accomplished with relative ease.

LIST OF REFERENCES

1. Bailey, A.E., ed., Cottonseed, Interscience Publishers, New York, 1948.
2. Brewster, John M., "Comparative Economics of Different Types of Cottonseed Oil Mills and Their Effects on Oil Supplies, Prices, and Returns to Growers," USDA, Agricultural Marketing Service, Market Research Report No. 54, February, 1954.
3. Clark, S.P., "Evaluation of Processing Alternatives to Saw Delinting of Cottonseed," Journal of the American Oil Chemist's Society, Vol. 53, 1976, pp. 684-690.
4. Ethridge, M. Dean, "A Regional Economic Assessment of Cottonseed: Wholesale Values, Farm Prices, and Impact on Producer Incomes," Proceedings of the Beltwide Cotton Production Research Conferences, National Cotton Council, January, 1978.
5. Guthrie, Kenneth M., Processing Plant Estimating Evaluation and Control, Craftsman Book Company of America, Salana Beach, California, 1974.
6. Hise, Billy R., Don E. Ethridge, and Dale L. Shaw, "Processing Plant Cost Estimation System: Documentation and User's Guide," National Economics Division, ESCS, USDA, and Ag. Economics Dept., College of Ag. Sciences, Texas Tech University, Publication No. T-1-189, April, 1980.
7. Hise, Billy R., and Don E. Ethridge, "An Economic Analysis of Hulling Undelinted Cottonseed," National Economics Division, ESCS, USDA, and Ag. Economics Dept., College of Ag. Sciences, Texas Tech University, Publication No. T-1-188, April, 1980.
8. McArthur, W.C., et al., "The Cotton Industry in the United States: Farm to Consumer," National Economics Division, ESCS, USDA, and College of Ag. Sciences, Texas Tech University, Publication No. T-1-186, April, 1980.
9. Murrill, Paul W., and Cecil L. Smith, Fortran IV Programming, Intext Educational Publishers, New York, 1973, Second Edition.
10. Shaw, Dale L., "Economic-Engineering Simulation of Cotton Ginning Costs, GINMODEL: Program Documentation and User's Guide," Economic Research Service, USDA, and College of Ag. Sciences, Texas Tech University, Publication No. T-1-174, August, 1978.

Appendix I

Computer Program Variable Names and Explanations

MAIN PROGRAM

<u>Variable</u>	<u>Explanation</u>
ABP	Average borrowing period of short term capital (in weeks)
AC(K,J)	Average total cost of cost center K at capacity utilization level J (\$/ton)
ACC(J)	Average cost of cottonseed (plus transportation) at capacity utilization level J (\$/ton)
ACI(J)	Average cost of cottonseed (plus transportation) plus interest cost at capacity utilization level J (\$/ton)
AFC(J)	Average fixed cost at capacity utilization level J (\$/ton)
AIC(J)	Average interest on operating capital on purchases of cottonseed at capacity utilization level J (\$/ton)
AIOC(K,J)	Average interest on operating capital of cost center K at capacity utilization level J (\$/ton)
ANR(J)	Average net revenue of the mill at capacity utilization level J (\$/ton)
APFC(K,J)	Average fixed cost of cost center K at capacity utilization level J (\$/ton)
APSC(K,J)	Average variable cost of cost center K at capacity utilization level J (\$/ton)
AREV(J)	Average revenue of the mill at capacity utilization level J (\$/ton)
ATC(J)	Average total cost of the mill at capacity utilization level J (\$/ton)
AVC(J)	Average variable cost of the mill at capacity utilization level J (\$/ton)
AVCA(K,J)	Average variable cost of lab analysis of cost center K at capacity utilization level J (\$/ton)
AVCB(K,J)	Average variable cost of bagging and ties of cost center K at capacity utilization level J (\$/ton)
AVCE(K,J)	Average variable cost of electricity of cost center K at capacity utilization level J (\$/ton)
AVCF(K,J)	Average variable cost of fuel of cost center K at capacity utilization level J (\$/ton)

<u>Variable</u>	<u>Explanation</u>
AVCH(K,J)	Average variable cost of solvent of cost center K at capacity utilization level J (\$/ton)
AVCI(K,J)	Average variable cost of product insurance of cost center K at capacity utilization level J (\$/ton)
AVCL(K,J)	Average variable cost of labor of cost center K at capacity utilization level J (\$/ton)
AVCM(K,J)	Average variable cost of miscellaneous items of cost center K at capacity utilization level J (\$/ton)
AVCR(K,J)	Average variable cost of repairs of cost center K at capacity utilization level J (\$/ton)
AVCW(K,J)	Average variable cost of water of cost center K at capacity utilization level J (\$/ton)
CAP(J)	Capacity of plant in tons (processed) per year at capacity utilization level J (tons)
CL(J)	Capacity utilization level J (percent)
CPP	Capacity of plant in tons crushed per day (average at 100% capacity utilization)
CU	Capacity utilization level as a fraction of mill capacity
DAYD	No. of days down for repairs between seasons at 100% capacity utilization
DAYP	No. of days processing at 100% capacity utilization
DAYU	No. of days unloading at 100% capacity utilization
DD(J)	Days down for repairs between seasons at capacity utilization level J
DF(J)	Days dormant plus days down for major repairs during the year at capacity utilization level J
DP(J)	No. of days processing at capacity utilization level J
DU(J)	No. of days unloading at capacity utilization level J
ELER	Average electricity charge in \$ per kilowatt hour (\$/KWH)
ELEM	Average monthly electricity charge when the mill is not processing (dollars)
HRS(K,J)	Operating hours of machinery in unloading or storage cost center K at capacity utilization level J

<u>Variable</u>	<u>Explanation</u>
ICC(J)	Total interest on operating capital used in the purchase of cottonseed at capacity utilization level J (\$)
IOC(K,J)	Interest on operating capital of cost center K at capacity utilization level J
J	No. of capacity utilization levels calculated
K	No. of cost centers of the mill
M	No. of cost centers which are actual processing steps in the mill
N(1)	Area 1=Southeast 2=Southwest 3=West
N(2)	Extraction technology 1=screwpress 2=direct solvent 3=prepress solvent
N(3) 1=Yes 0=No	Is office included as a cost center?
N(4) 1=Yes 0=No	Is unloading included as a cost center?
N(5) 1=Yes 0=No	Is cottonseed storage included as a cost center?
N(6)	No. of mill processing steps (from cleaning-extraction)
N(7) 1=Yes 0=No	Is oil storage included as a cost center?
N(8) 1=Yes 0=No	Is meal storage included as a cost center?
N(9) 1=Yes 0=No	Is hull storage included as a cost center?
N(10) 1=Yes 0=No	Is linter storage included as a cost center?
N(11) 1=Yes 0=No	Control variable to print total variable cost by item by cost center
N(12) 1=Yes 0=No	Control variable to print average variable cost by item by cost center
N(13) 1=Yes 0=No	Control variable to print average cost of the variable inputs labor, electricity, repairs, lab analysis, bagging and ties, fuel, miscellaneous, solvent, insurance, and water

<u>Variable</u>	<u>Explanation</u>
N(I)	Vector of control variables (I=1, . . . ,13)
NPD(J)	No. of days the plant does not process seed during the processing year at capacity utilization level J
PC(K,J)	Total cost of cost center K at capacity utilization level J
PCS	Average price paid per ton for cottonseed including transportation (in \$)
PFC(K)	Cost center K fixed cost (\$)
PREP(K)	Fraction of repairs charged to cost center K
R	Interest rate on long term capital borrowings (decimal point value)
RS	Interest rate on short term capital borrowings (decimal point value)
TC(J)	Total cost of the mill at capacity utilization level J (\$)
TCAP	Total capacity of mill at 100% capacity utilization level (tons)
TCC(J)	Total cost of cottonseed at capacity utilization level J (less interest cost) (\$)
TCI(J)	Total cost of cottonseed at capacity utilization level J (includes interest on operating capital) (\$)
TCWT(J)	Total cost of water for the mill at capacity utilization level J (\$)
TITLE(K,I)	Title of cost center K
TMR	Total mill repair cost per ton of seed processed (\$/ton)
TNR(J)	Total net revenue of the mill at capacity utilization level J (\$)
TPC(K,J)	Total variable cost of cost center K (less interest on operating capital) at capacity utilization level J (\$)
TPSC(K,J)	Total variable cost of cost center K at capacity utilization level J (includes interest on operating capital) (\$)
TPSI	Time period (as a fraction of a year) for determining interest on short term capital

<u>Variable</u>	<u>Explanation</u>
TREV(J)	Total revenue of the mill at capacity utilization level J (\$)
TVC(J)	Total variable cost of the mill at capacity utilization level J (\$)
TVCA(J)	Variable cost of lab analysis for the mill per ton of seed processed at capacity utilization level J (\$)
TVCB(J)	Variable cost of bagging and ties for the mill per ton of seed processed at capacity utilization level J (\$)
TVCE(J)	Variable cost of electricity for the mill per ton of seed processed at capacity utilization level J (\$)
TVCF(J)	Variable cost of fuel for the mill per ton of seed processed at capacity utilization level J (\$)
TVCH(J)	Variable cost of solvent for the mill per ton of seed processed at capacity utilization level J (\$)
TVCI(J)	Variable cost of product insurance for the mill per ton of seed processed at capacity utilization level J (\$)
TVCM(J)	Variable cost of miscellaneous items for the mill per ton of seed processed at capacity utilization level J (\$)
TVCR(J)	Variable cost of repairs for the mill per ton of seed processed at capacity utilization level J (\$)
TVCW(J)	Variable cost of water for the mill per ton of seed processed at capacity utilization level J (\$)
VCA(K,J)	Variable cost of lab analysis in cost center K at capacity utilization level J (\$)
VCB(K,J)	Variable cost of bagging and ties in cost center K at capacity utilization level J (\$)
VCE(K,J)	Variable cost of electricity in cost center K at capacity utilization level J (\$)
VCF(K,J)	Variable cost of fuel in cost center K at capacity utilization level J (\$)
VCH(K,J)	Variable cost of hexane in cost center K at capacity utilization level J (\$)
VCI(K,J)	Variable cost of product insurance in cost center K at capacity utilization level J (\$)

<u>Variable</u>	<u>Explanation</u>
VCL(K,J)	Variable cost of labor in cost center K at capacity utilization level J (\$)
VCM(K,J)	Variable miscellaneous cost in cost center K at capacity utilization level J (\$)
VCR(K,J)	Variable cost of repairs in cost center K at capacity utilization level J (\$)
VCW(K,J)	Variable cost of water in cost center K at capacity utilization level J (\$)
VINR	Product insurance rates (\$/\$1,000 value)
WTRR	Average water rate (\$/1,000 gal.)
WTRM	Average water rate per month charge when mill is not processing (\$)

SUBROUTINE FIX(TFC)

<u>Variable</u>	<u>Explanation</u>
AEC	Annual equivalency cost of the fixed cost item (\$)
AEC1	Annual equivalency cost of a depreciable fixed cost item (\$)
CHP	Connected horsepower of the machinery item (horsepower)
DEP1	Annual depreciation cost of the fixed cost item (\$)
FOB	F.O.B. cost of the depreciable items or installed cost of the depreciable items or annual cost of the non-depreciable items (\$)
FOB1	Cost of the depreciable fixed cost items including the installation when installation is included as a fraction of FOB (\$)
ID	Identification for depreciable, non-depreciable, land, or cost center title cards
INSR	Insurance rate for fixed cost items which are insurable (\$/\$1,000 value)
INS	Annual insurance expense associated with the fixed cost item (\$)
INST	Installation cost as a fraction of F.O.B. cost of the fixed cost item
INT	Annual interest expense associated with the fixed cost item (\$)
NAME(I)	Name of cost center or a fixed cost item
NUM	Number of the fixed cost item needed
PFC(K)	Total fixed cost of cost center K
REP	Fixed repair rate (as a fraction of the F.O.B. cost)
REP1	Annual fixed repair cost associated with the fixed cost item (\$)
SAL	Salvage value (as a fraction of the F.O.B. cost of the depreciable item)
SALL	Salvage value of the fixed cost item (\$)
TAX	Annual property tax associated with the fixed cost item (\$)

<u>Variable</u>	<u>Explanation</u>
TAXR	Property tax rate for fixed cost items which are taxable (\$/100 value)
TCH1	Total connected horsepower of all machinery and equipment of the mill
TCHP(K)	Total connected horsepower of the machinery and equipment in cost center K
TDE1	Total depreciation of all fixed cost items in the mill (\$)
TDEP(K)	Total depreciation of fixed cost items in cost center K (\$)
TFC	Total fixed cost of the entire mill (\$)
TIN1	Total interest of all fixed cost items in the mill (\$)
TINS(K)	Total insurance cost of fixed cost items in cost center K (\$)
TINT(K)	Total interest of fixed cost items in cost center K (\$)
TIS1	Total insurance cost of fixed cost items in the mill (\$)
TNDC	Total non-depreciable fixed cost of the mill (\$)
TND(K)	Total non-depreciable fixed cost in cost center K (\$)
TREP(K)	Total fixed repair cost of cost center K (\$)
TRP1	Total fixed repair cost of the mill (\$)
TTAX(K)	Total tax cost of items within cost center K (\$)
TTX1	Total tax cost of all items within the mill (\$)
TWT1	Total water cost of the mill (\$)
TWTR(K)	Total water cost of cost center K (\$)
WTR	Water requirements of the item (1,000 gals./day)
YRS	Years of useful life of the depreciable assets

SUBROUTINE NR(TR)

<u>Variable</u>	<u>Explanation</u>
ID	Identification of the type of revenue generated
NUM	Number of pounds of the output product item produced per ton of seed processed
PR	Expected average price per unit for which the product will be sold over the year
REVH	Total revenue generated by the sale of hulls during the year (at 100% capacity utilization) (\$)
REVL	Revenue generated by the sale of one type of linters during the year (at 100% capacity utilization) (\$)
REVM	Total revenue generated by the sale of meal during the year (at 100% capacity utilization) (\$)
REVO	Total revenue generated by the sale of oil during the year (at 100% capacity utilization) (\$)
TRL	Total revenue generated by the sale of all cuts of linters during the year (at 100% capacity utilization) (\$)
TR	Total revenue generated by sale of all products (at 100% capacity utilization) (\$)

SUBROUTINE STAGE

<u>Variable</u>	<u>Explanation</u>
DLAB(K)	Labor cost of cost center K when the mill is not operating i.e., down for repairs (\$)
DLBC	Labor cost of one group of workers within a cost center when the mill is not operating i.e., down for repairs (\$)
ID	Identification of the variable input item
NUM1	Number of variable cost item used during processing period
NUM2	Number of variable cost item used during repair period
NUM3	Number of variable cost item used during dormant period
PLAB(K)	Labor cost of cost center K when the mill is processing (\$)
PLBC	Labor cost of one group of workers within a cost center when the mill is processing (\$)
PREP(K)	Fraction of total variable repair cost charged to a cost center K
PR	Price of variable input item
RLAB(K)	Labor cost of cost center K during period of repairs between seasons (\$)
RLBC	Labor cost of one group of workers within a cost center during period of repairs between seasons (\$)
TANL(K)	Total lab analysis cost of cost center K (\$)
TBAG(K)	Total bagging and ties cost of cost center K (\$)
TFUEL(K)	Total fuel cost of cost center K (\$)
THEX(K)	Total hexane cost of cost center K (\$)
TIME(K)	Time variable for determining electricity usage in cost center K
TITLE(K,I)	Title of cost center K
TMIS(K)	Total miscellaneous cost of cost center K (\$)
TRK	Average capacity of trucks which unload cottonseed at mill unloading cost center (tons/truck)
UF	No. of unloading facilities of the mill

Appendix II

Main Program and Subroutines Flow Diagrams

MAIN PROGRAM

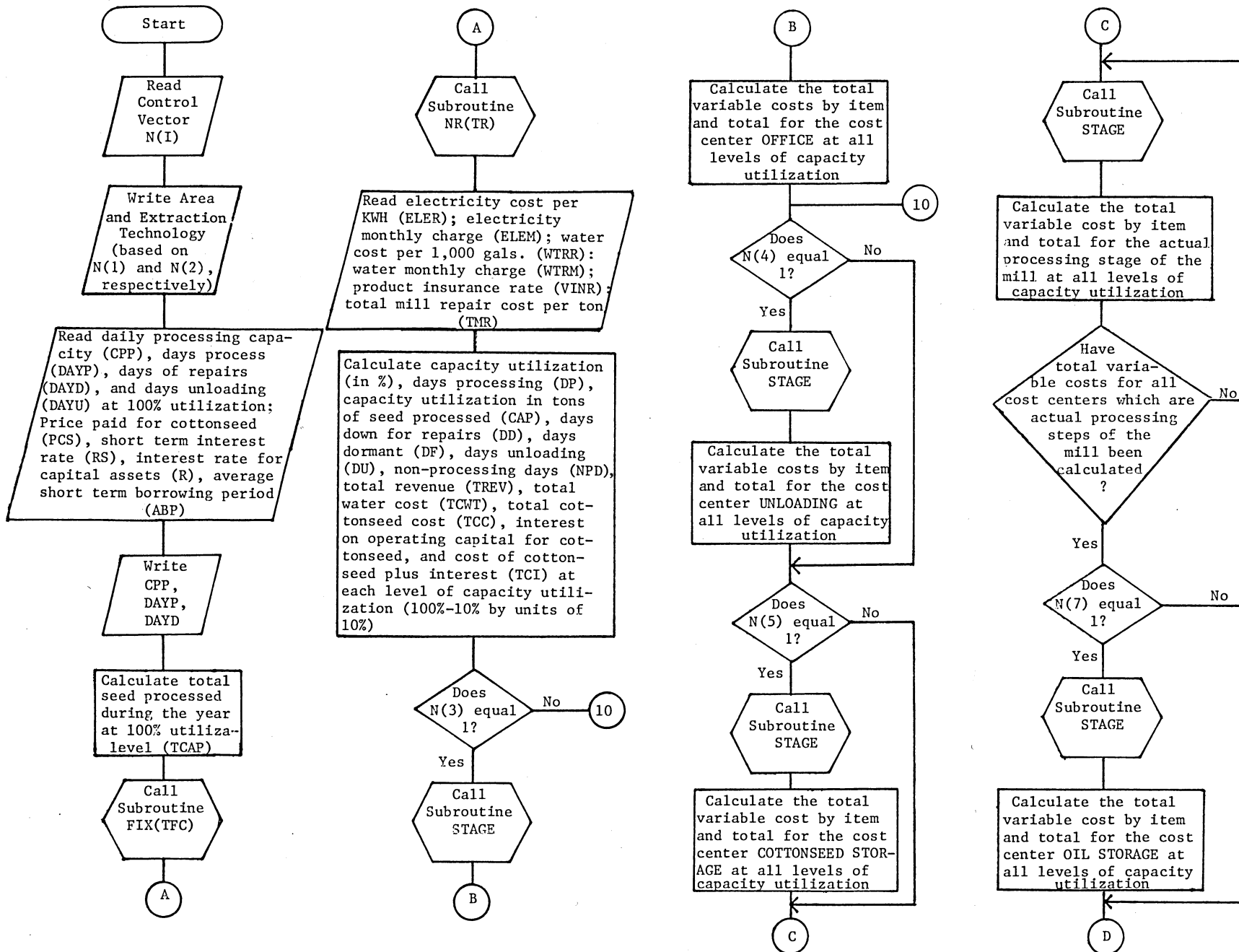

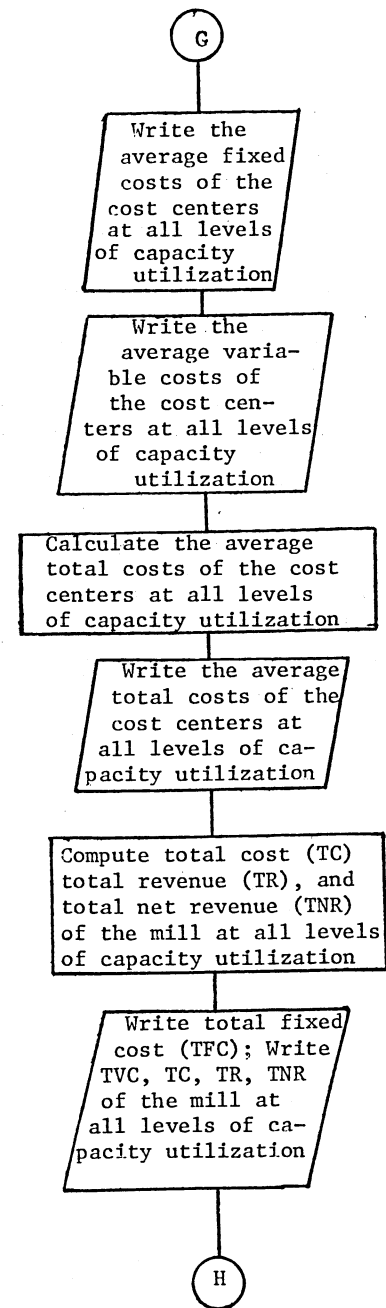
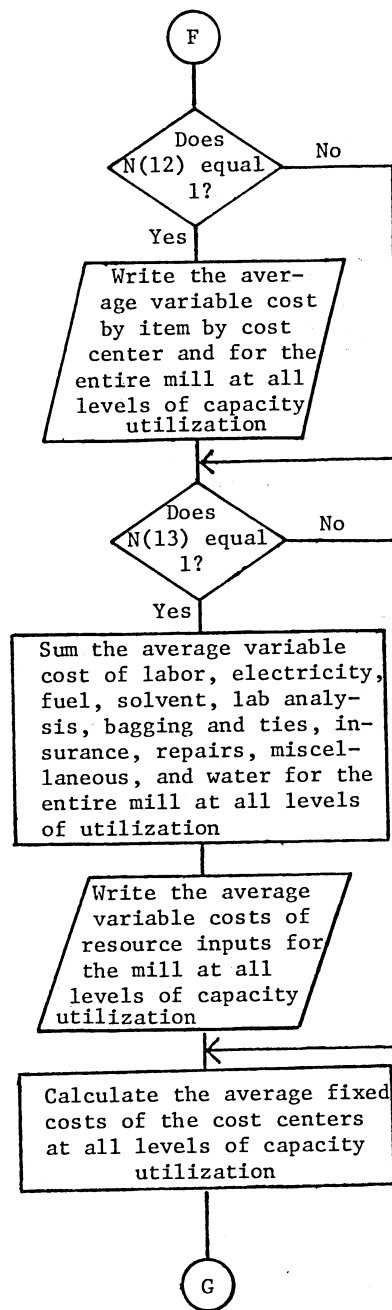
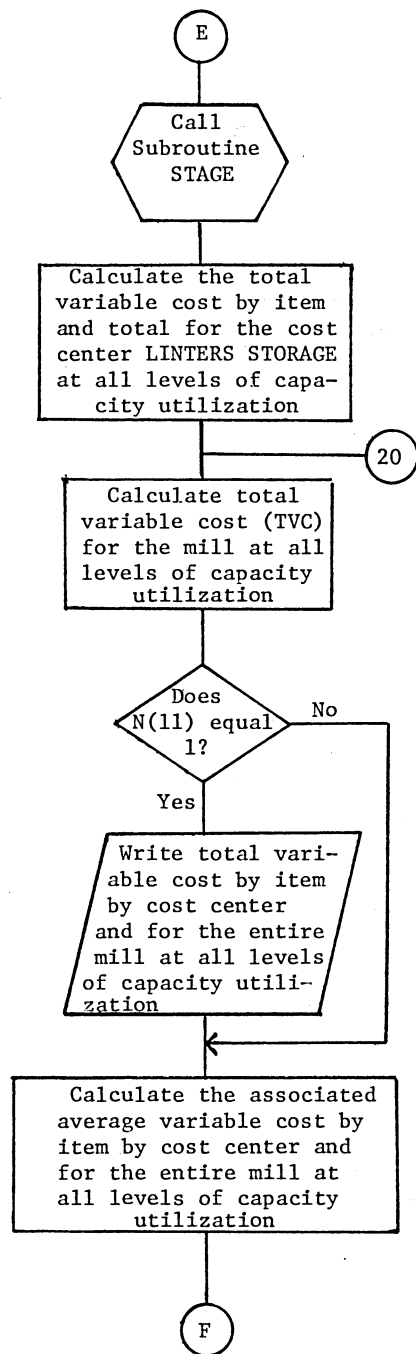
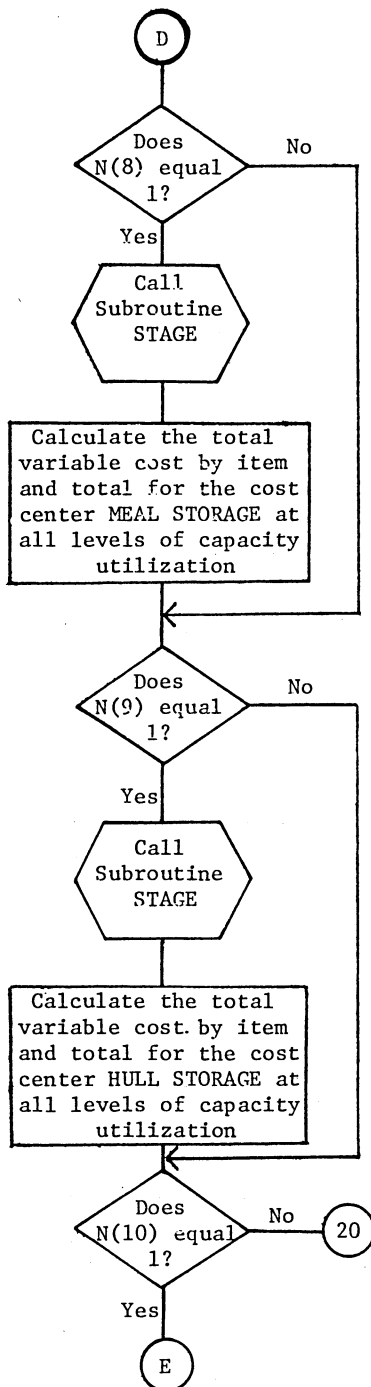

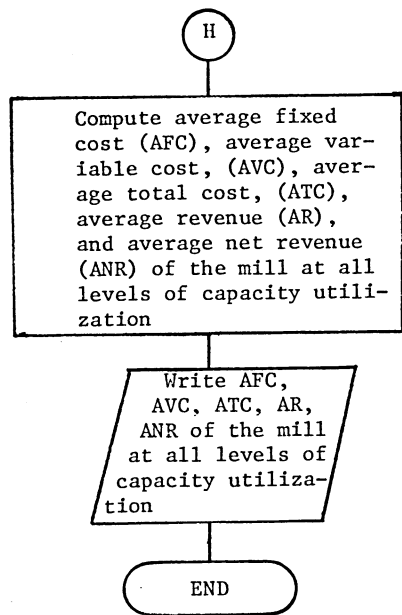

Subroutine FIX(TFC)

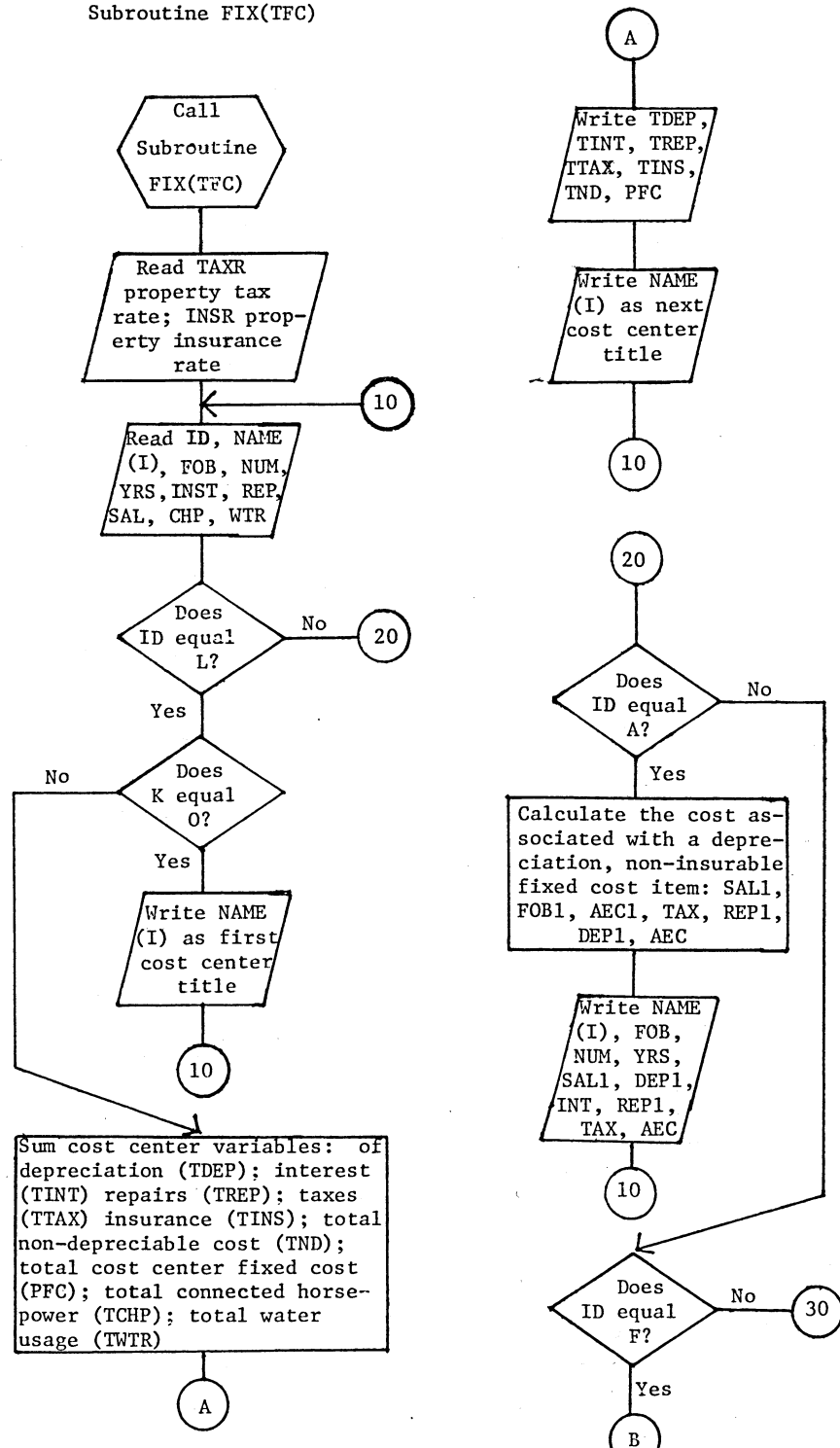

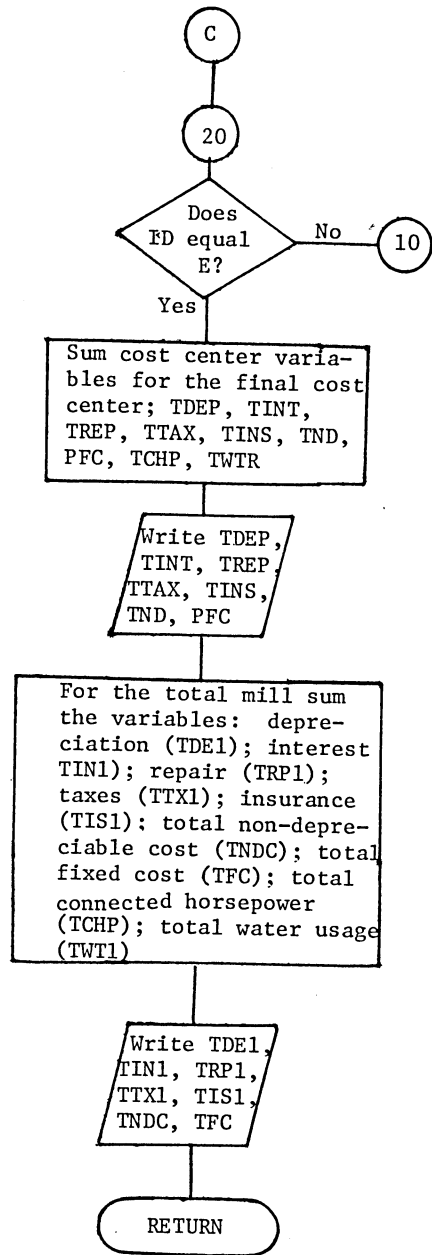
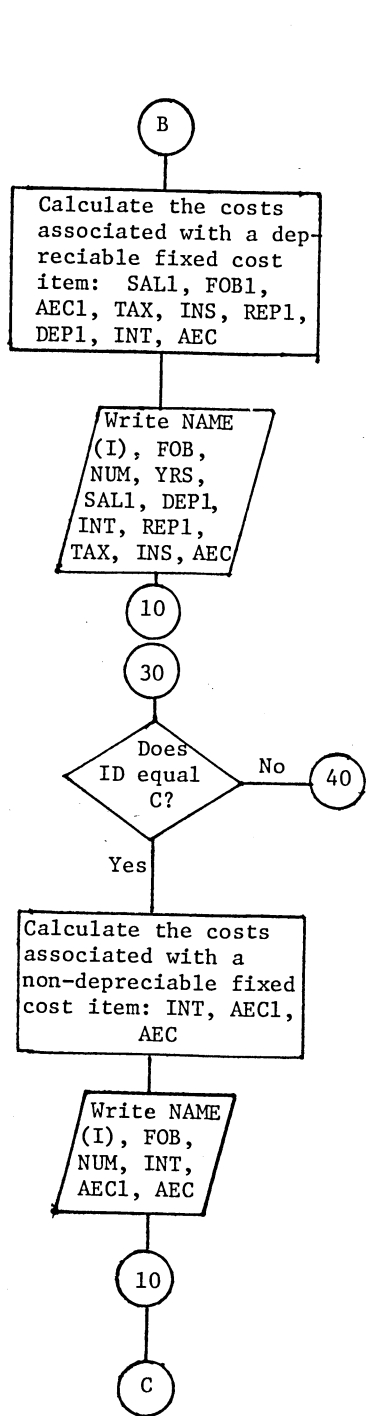

SUBROUTINE NR(TR)

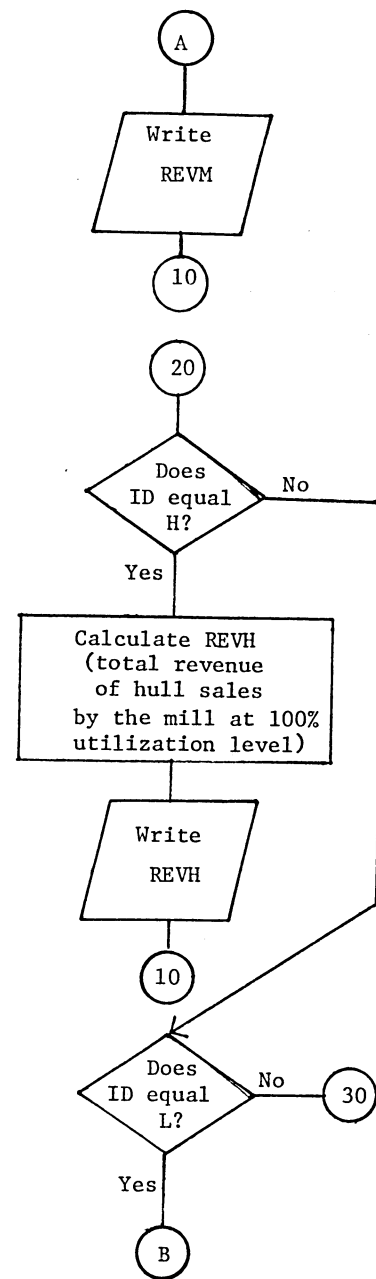
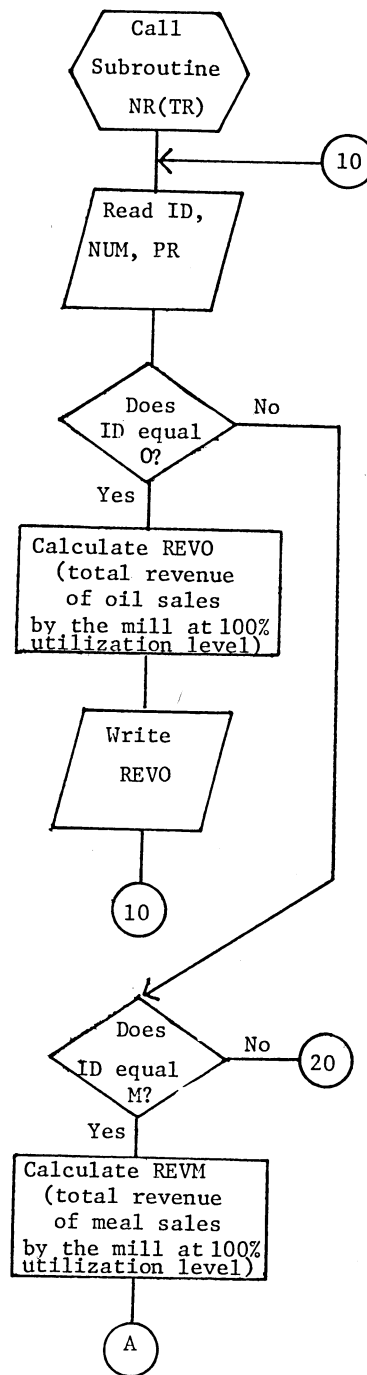

SUBROUTINE STAGE

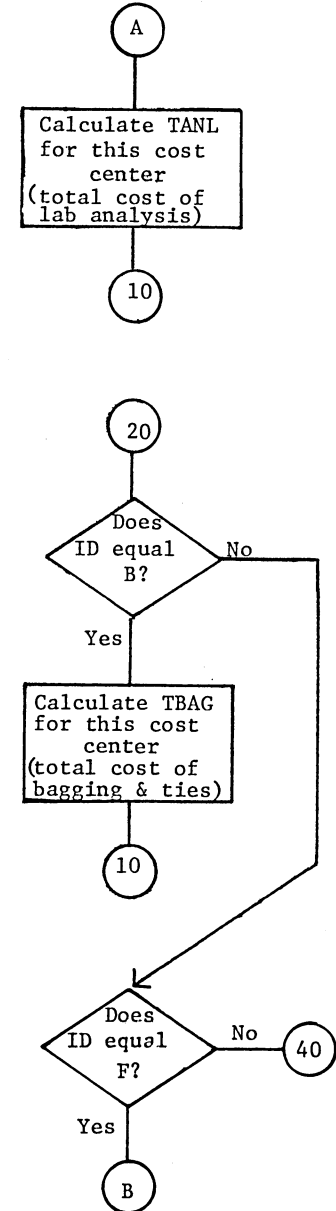
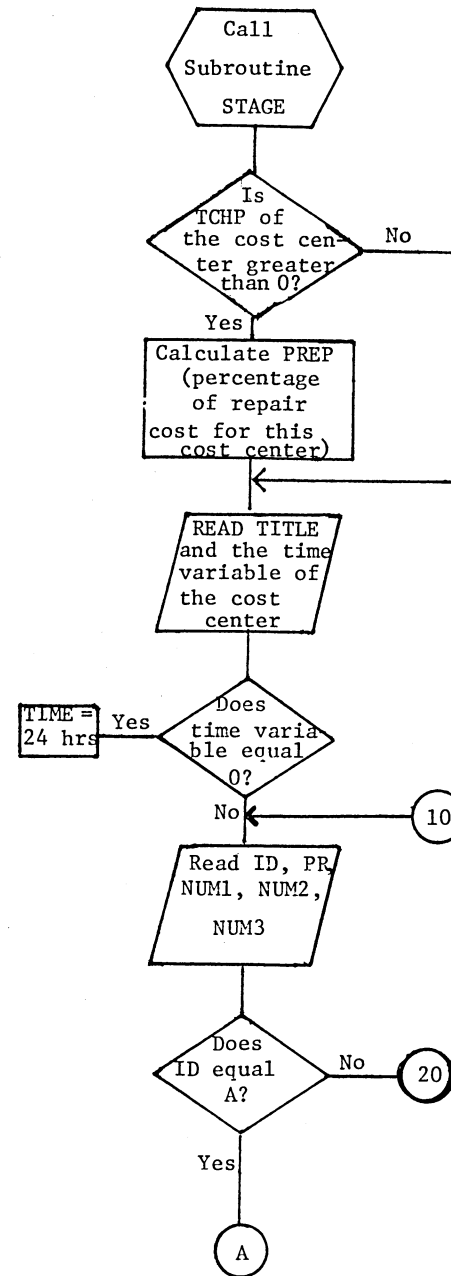
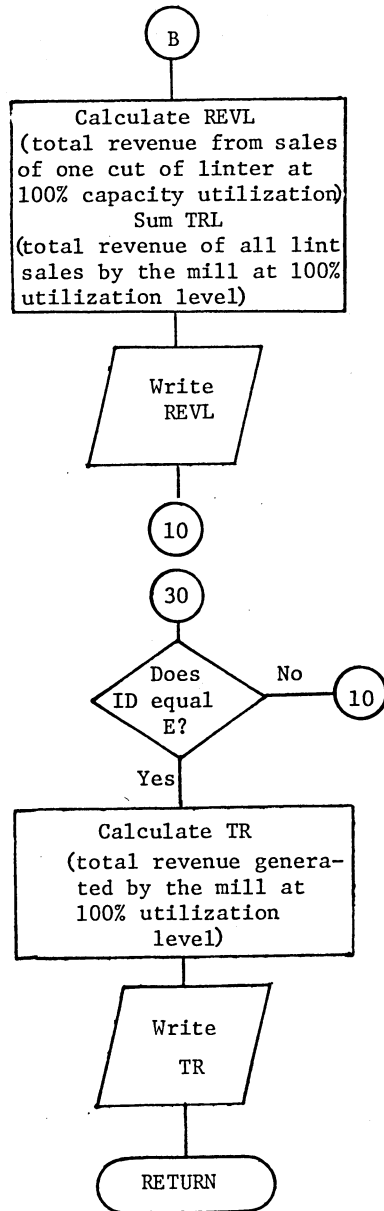

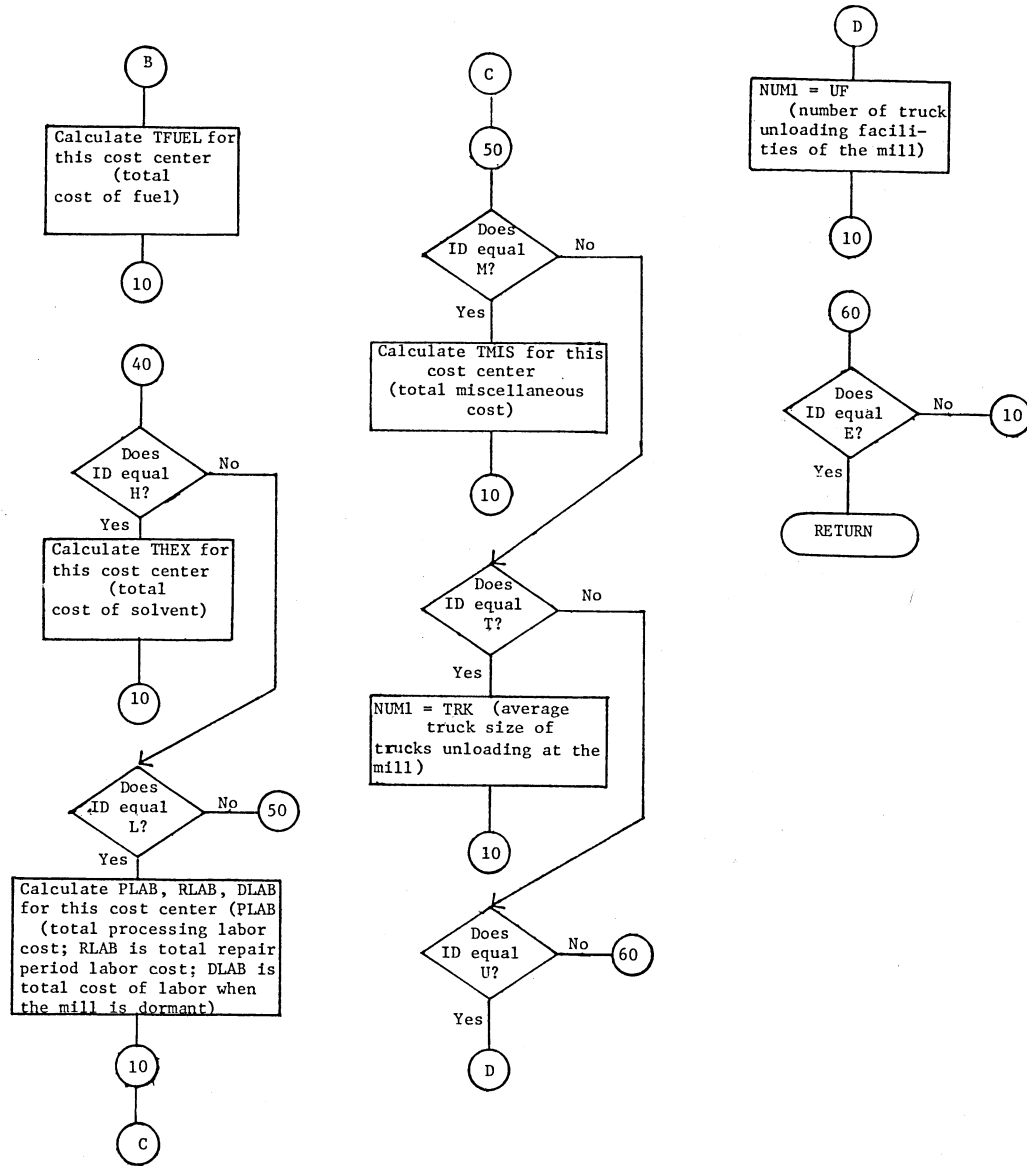

APPENDIX III

Input Variable Names,
Explanations, and Card Format

Input Variable Names, Explanation and Card Format

<u>Control Card</u>				
<u>Card No.</u> ¹	<u>Column</u>	<u>Variable</u>		<u>Explanation</u>
1	1	N(1)	1=South 2=Southwest 3=West	Geographic area of the United States
1	2	N(2)	1=Screwpress 2=Direct Solvent 3=Prepress Solvent	Extraction technology
1	3	N(3)	1=Yes 0=No	Is office included as a cost center?
1	4	N(4)	1=Yes 0=No	Is unloading included as a cost center?
1	5	N(5)	1=Yes 0=No	Is seed storage included as a cost center?
1	6-8	N(6)		No. of mill processing steps included as cost centers
1	9	N(7)	1=Yes 0=No	Is oil storage included as a cost center?
1	10	N(8)	1=Yes 0=No	Is meal storage included as a cost center?
1	11	N(9)	1=Yes 0=No	Is hull storage included as a cost center?
1	12	N(10)	1=Yes 0=No	Is linter storage included as a cost center?
1	15	N(11)	1=Yes 0=No	Print total variable cost by item by cost center?
1	18	N(12)	1=Yes 0=No	Print average variable cost by item by cost center?
1	21	N(13)	1=Yes 0=No	Print variable costs at each utilization level for labor, electricity, repairs, fuel, lab analysis, bagging and ties, fuel miscellaneous, solvent, product insurance, and water per ton of seed processed for mill?

¹ Card number references are to input data card arrangements shown in Appendix IV. Many cards or card sets are repeated.

General Data

<u>Card No.</u>	<u>Column</u>	<u>Variable</u>	<u>Explanation</u>
2	1-5	CPP	Capacity of plant (tons/day)
2	6-10	DAYP	Days processing (at 100% utilization)
2	11-15	DAYD	Days down for repairs between seasons (at 100% utilization)
2	16-20	DAYU	Days of the cottonseed receiving and unloading period
2	21-30	PCS	Price paid for cottonseed including transportation (\$/ton)
2	31-35	RS	Short term interest rate (example: 15 percent = .15)
2	36-40	R	Long term interest rate (example: 10 percent = .1)
2	41-45	ABP	Average period of short term borrowing (weeks)

Fixed Cost Information Used in

Subroutine FIX(TFC)

3	1-5	TAXR	Property tax rate in \$/\$100 valuation (example: \$1.40/\$100 value = 1.4)
3	6-10	INSR	Insurance rate on capital asset items in \$/\$1000 value (example: \$6/\$1000 value = 6)
4	1	ID	Identification (must enter L)
4	2-21	LJ* NAME(I)	Cost center name (example: OFFICE)
5	1	ID	Identification (must enter A)
5	2-21	LJ NAME(I)	Name of non-insurable asset (example: LAND)

* LJ means the input item is left-hand justified. The remaining variables are right-hand justified. All format specifications are for whole numbers, therefore, a decimal must be punched whenever the value of a variable is not a whole number.

<u>Card No.</u>	<u>Column</u>	<u>Variable</u>	<u>Explanation</u>
5	22-30	FOB	Cost per unit of the fixed cost item
5	31-35	NUM	No. of units of the fixed cost items needed
5	36-38	YRS	Years of useful life
5	39-43	INST	Installation cost of the item (as a fraction of the F.O.B. cost)
5	44-47	REP	Fixed repair cost of the item (as a fraction of the F.O.B. cost)
5	48-51	SAL	Salvage value of the fixed cost item (as a fraction of the F.O.B. cost)
5	52-55	CHP	Connected horsepower of the total amount of equipment (not connected horsepower of one machine but the total connected of all machines specified)
5	56-63	WTR	Water usage of the fixed cost items (in 1000 gals.; total water usage of all machines specified)
6	1	ID	Identification (must enter F)
6	2-21 LJ	NAME(I)	Name of the depreciable insurable fixed cost item (example: BUILDING)
6	22-30	FOB	F.O.B. cost of the depreciable item per unit (may include or exclude installation cost)
6	31-35	NUM	No. of units of the fixed cost items needed
6	36-38	YRS	Years of useful life
6	39-43	INST	Installation cost of the item (as a fraction of the F.O.B. cost)
6	44-47	REP	Fixed repair rate for the item (as a fraction of the F.O.B. cost)

<u>Card No.</u>	<u>Column</u>	<u>Variable</u>	<u>Explanation</u>
6	48-51	SAL	Salvage value of the fixed cost item (as a fraction of F.O.B. cost)
6	52-55	CHP	Connected horsepower of the total amount of equipment (not connected horsepower of one machine but the total connected of all machines specified)
6	56-63	WTR	Water usage of the fixed cost items (in 1000 gals.), (complete water usage of all machines specified)
7	1	ID	Identification (must enter C)
7	2-21 LJ	NAME(I)	Name of the non-depreciable non-insurable fixed cost item (example: MILL MANAGER)
7	22-30	FOB	Cost per unit of the item during a one year period
7	31-35	NUM	No. of units of the fixed cost items needed
8	1-3	END	Must enter END (to show the end of the fixed cost data)

Information Used in Subroutine NR(TR)

Product and Revenue

9	1	ID**	Identification
9	2-10	NUM	Number of pounds of product produced from one ton of cottonseed
9	11-20	PR	Average per unit price expected for the product: oil in \$/lb. meal in \$/ton hulls in \$/ton linters in \$/lb.

** Must have a card for each product produced.

<u>Card No.</u>	<u>Column</u>	<u>Variable</u>	<u>Explanation</u>
9			If ID = O, the product is oil;
10			If ID = M, the product is meal;
11			If ID = H, the product is hulls;
12			If ID = L, the product is linters.
13	1	E	Must enter E (to show the end of the revenue data)

Variable Costs Information Used in

Both the Main Program and Subroutine Stage

14	1-10	ELER	Average price paid for electricity in \$/Kwh (example: \$.05/KWH = .05)
14	11-20	ELEM	Average monthly charge for electricity when the mill is not processing (\$)
14	21-30	WTRR	Average price paid for water in \$/1,000 gals. (example: \$1.50/1,000 gals. = 1.5)
14	31-40	WTRM	Average monthly charge for water when the mill is not operating (\$)
14	41-50	VINR	Product insurance rate for products and cottonseed in \$/\$1,000-value (example: \$6/\$1,000-value = 6)
14	51-60	TMR	Total cost of mill repairs expected in the processing year (dollars/ton of seed processed)
15	1-20 LJ	TITLE(K,J)	Title of the cost center
15	21-30	TIME(K)	Average hours per day machinery in the cost center will operate (hours). Hours to unload one truck in the unloading cost center. Default value is 24.
16	1	ID	Type of variable cost item (see explanation below)
16	2-10	PR	Price per unit of the variable input item

<u>Card No.</u>	<u>Column</u>	<u>Variable</u>	<u>Explanation</u>
16	11-20	NUM1	Number needed of the variable input item as explained below
16	21-30	NUM2	Number needed of the variable input item as explained below
16	31-40	NUM3	Number needed of the variable input item as explained below
17	1	E	Must enter E (to show the end of the cost center data)

If ID = A, the variable input item is lab analysis. The total cost of lab analysis is based on the amount of seed processed; therefore, only the cost per ton of seed processed is needed as data and is entered as PR in cols. 2-10.

If ID = B, the variable input item is bagging and ties. The cost per pattern of bagging and ties is placed in cols. 2-10. The amount of linters produced (in lbs./ton of seed processed) is entered as NUM1 (cols. 11-20) for 1st cuts; NUM2 (cols. 21-30) for 2nd cuts; and NUM3 (31-40) for other cuts. If more than three cuts are made, another card for bagging and ties is needed.

If ID = F, the variable input item is fuel. The specific fuel type is not specified by the input data. The average price per unit (per 1000 cu.ft. if it is natural gas; per gallon if it is fuel oil; etc.) is enter as PR in cols. 2-10 and the average fuel usage (in the appropriate units) per ton of seed processed is entered as NUM1 in cols. 11-20.

If ID = H, the variable input item is solvent. The cost per gallon is entered as PR in cols. 2-10 and the solvent loss (in gallons) per ton of seed processed is entered as NUM1 in cols. 11-20.

If ID = L, the variable input item is labor. The weekly wage rate of the employee (dollars per week including benefits) is entered as PR in cols. 2-10. The number of employees hired at this wage rate when the mill is processing is entered as NUM1 (cols. 11-20); the number of employees hired at this wage rate when the mill is down for major repairs between seasons is entered as NUM2 (cols. 21-30), and the number of employees which will be hired at this wage rate if the mill has a dormancy period is entered as NUM3 (cols. 31-40).

If ID = M, the variable input item is miscellaneous. The miscellaneous cost is entered as a cost per ton of seed processed in cols. 2-10 (PR). The number needed is not necessary because the cost only reflects a cost per ton of seed processed and not usage per ton of seed processed.

If ID = T, the variable input item is average truck size (needed only in the UNLOADING cost center data). The average truck size is entered as NUM1 (cols. 11-20) in tons per truck.

Card No.

Column

Variable

Explanation

If ID = U, the variable input item is the number of unloading facilities of the mill (needed only in the unloading cost center data). The number of unloading facilities is entered as NUM1 (cols. 11-20).

APPENDIX IV

Input Data Cards Arrangement

	Repeat cards 15-17 as needed for each cost center of the mill	
E	End of each cost center variable cost data cards	17
	Repeat card 16 for each variable input	
	Variable input data card	16
	Cost center title card and time variable	15
	ELER, ELEM, WTRR, WTRM, VINR, TMR	14
E	End of revenue data card	13
	Repeat card 12 for each cut of linters	
L	Linters output and price	12
H	Hull output and price	11
M	Meal output and price	10
O	Oil output and price	9
E	End of fixed cost data card	8
	Repeat cards 4-7 as needed for each cost center	
	Repeat cards 5-7 as needed for fixed cost items within a cost center	
C	Non-depreciable fixed cost item	7
F	Depreciable fixed cost item	6
A	Depreciable non-insurable fixed cost item	5
L	Cost center title card	4
	TAXR, INSR	3
	CPP, DAYP, DAYD, DAYU, PCS, RS, R, ABP	2
	Control card	1
ID	Explanation	Card Order Number

APPENDIX V

Card Deck Arrangement

Card Deck Arrangement Including the
Program, Data Set, and Necessary Job
Control Language

This cottonseed oil mill model was programmed in Fortran IV, Level G and has been run on the ITEL AS/6 computer system at Texas Tech University. The card deck arrangement including the job control language needed to run the program is:

```
// JOB CARD

// EXEC FORTGCLG

//SYSIN DD *

    MAIN PROGRAM

    SUBROUTINE FIX(TFC)

    SUBROUTINE NR(TR)

    SUBROUTINE STAGE

/*

//GO.SYSIN DD *

    DATA SET

/*

//
```

Appendix VI
The Computer Program

MAIN

```

C PROCESSING COST ESTIMATION SYSTEM REVISED FOR COTTONSEED OIL MILL MODEL
C N IS CONTROL VECTOR
0001 COMMON N(13),PCS,R,RS,CPP,CAP(10),CP(10),DD(10),PFC(20),TCAP,K,
    *TINT(20),TDEP(20),TCHP(20),TREP(20),TWTP(20),DF(10),TREV(10),
    *TDE1,TIN1,TRP1,TCH1,TWT1,TTAX(20),TINS(20),CL(10),NPD(10),TND(20)
    *,PREP(20),TRA(20),TANL(20),TFUEL(20),UF,
    *THEX(20),PLAB(20),RLAB(20),DLAB(20),THIS(20),TITLE(20,5)
0002 *,TSURE(20),REVG,PEVM,PEVH,TRL,HRS(20,10),TRK,TIME(20)
    DIMENSION VCL(20,10),VCE(20,10),VCA(20,10),VCH(20,10),VCW(20,10),
    *VCF(20,10),VCH(20,10),VCM(20,10),TPSC(20,10),APSC(20,10),
    *APFC(20,10),AREV(10),PC(20,10),JU(10),TCWT(10),AC(20,10),TVC(10)
    *,TC(10),TNR(10),ANR(10),AFC(10),AVC(10),ATC(10),TCC(10),TPC(20,10)
    *,VCI(20,10),VCR(20,10),AVCL(20,10),AVCE(20,10),AVCR(20,10)
0003 *,AVCA(20,10),AVCB(20,10),AVCF(20,10),AVCH(20,10),AVCI(20,10)
    DIMENSION AVCW(20,10),AVCM(20,10),AIOC(20,10),TCI(10),TVCL(10)
    *,ACC(10),AIC(10),ACI(10),TVCE(10),TVCA(10),TVCH(10),TVCR(10),
    *TVCW(10),TVCF(10),TVCI(10),TVCH(10),TVCM(10)
0004 REAL NPD,AIOC(20,10),ICC(10)
0005 WRITE(6,31)
0006 31 FORMAT('1',35X,'*****COTTONSEED OIL MILL SIMULATION MODEL*****
    ***/43X,'ECONOMICS, STATISTICS, AND COOPERATIVES SERVICE'/
    *51X,'USDA AND TEXAS TECH UNIVERSITY')
0007 READ(5,1) (N1,I=1,13)
0008 1 FORMAT(5I1,13,4I,3I3)
0009 WRITE(6,21)
0010 21 FORMAT(////,20X,'COTTONSEED OIL MILL DESCRIPTION',/)
C N(1) IS THE AREA OF MILL LOCATION
0011 IF (N(1).EQ.1) WRITE(6,2)
0012 2 FORMAT(/5X,'AREA = SOUTH')
0013 IF (N(1).EQ.2) WRITE(6,3)
0014 3 FORMAT(/5X,'AREA = SCUTHWEST')
0015 IF (N(1).EQ.3) WRITE(6,4)
0016 4 FORMAT(/5X,'AREA = WEST')
C N(2) IS THE EXTRACTION TECHNOLOGY OF THE MILL
0017 IF (N(2).EQ.1) WRITE(6,5)
0018 5 FORMAT(5X,'EXTRACTION TECHNOLOGY = SCREW PRESS')
0019 IF (N(2).EQ.2) WRITE(6,6)
0020 6 FORMAT(5X,'EXTRACTION TECHNOLOGY = DIRECT SOLVENT')
0021 IF (N(2).EQ.3) WRITE(6,7)
0022 7 FORMAT(5X,'EXTRACTION TECHNOLOGY = PRE-PRESS SOLVENT')
0023 DO 42 K=1,20
0024 DO 43 J=1,10
0025 VCL(K,J)=0.0
0026 VCE(K,J)=0.0
0027 VCR(K,J)=0.0
0028 VCM(K,J)=0.0
0029 VCH(K,J)=0.0
0030 VCW(K,J)=0.0
0031 VCI(K,J)=0.0
0032 VCA(K,J)=0.0
0033 VCB(K,J)=0.0
0034 VCF(K,J)=0.0
0035 43 CONTINUE
0036 42 CONTINUE
0037 READ(5,40) CPP,DAYP,DAYD,DAYU,PCS,RS,R,ABP
0038 40 FORMAT(4F5.0,F10.0,3F5.0)
0039 TPSI=ABP/52
0040 WRITE(6,41) CPP,DAYP,DAYD

```

```

0041 41 FORMAT(5X,'PROCESSING CAPACITY = ',F8.0,' TPD',/5X,
    *'NUMBER OF DAYS PROCESSING AT FULL CAPACITY = ',F6.0,' DAYS',/5X,
    *'NUMBER OF DAYS FOR REPAIRS BETWEEN SEASONS = ',F6.0,' DAYS')
0042 TCAP=CPP*DAYP
C SUBROUTINE FIX(TFC) CALCULATES THE FIXED COST ASSOCIATED WITH THE MILL
    CALL FIX(TFC)
0043 C SUBROUTINE NR(TR) CALCULATES THE TOTAL REVENUE GENERATED BY THE MILL
    CALL NR(TR)
0044 READ(5,50) FLEK,ELEM,WTFP,WTRM,VINR,TMR
0045 50 FORMAT(6F10.0)
0046 CU=1.0
0047 DO 500 J=1,10
0048 CL(J)=100*CU
0049 DP(J)=DAYP*CU
0050 CAP(J)=(DP(J))*CPP
0051 DD(J)=DAYD*CU
0052 DF(J)=(365-DD(J))-DP(J)
0053 DU(J)=DAYU*CU
0054 NPD(J)=365-DD(J)
0055 TRV(J)=TR*CU
0056 TCWT(J)=((TW*1*WTRR)*DP(J))+((NPD(J)/30)*WTRM)
0057 TCC(J)=PCS*CAP(J)
0058 ICC(J)=(TCC(J)*.5)*((NPD(J)/365)*RS)
0059 TCI(J)=TCC(J)+ICC(J)
0060 CU=CU-.1
0061 500 CONTINUE
C THIS SECTION OF THE MAIN PROGRAM CALCULATES THE VARIABLE COSTS OF
    THE MILL AT TEN UTILIZATION LEVELS (FROM 10% TO 10% UTILIZATION)
0062 IF (N(1).NE.1) GO TO 210
0063 WRITE(6,220) (CL(J),J=1,10)
0064 220 FORMAT(///30X,'TOTAL VARIABLE COSTS BY ITEM BY COST CENTER',
    *///1X,'UTILIZATION LEVEL',7X,F4.0,'%',9(F9.0,'%'))
0065 WRITE(6,230) (CAP(J),J=1,10)
0066 230 FORMAT(1X,'SEED PROCESSED ',10F10.0)
0067 WRITE(6,240) (DP(J),J=1,10)
0068 240 FORMAT(1X,'PROCESSING DAYS ',10F10.0)
0069 WRITE(6,280) (TCC(J),J=1,10)
0070 280 FORMAT(/1X,'COTTONSEED BUY'
    *1X,'COTTONSEED COST ',10F10.0)
0071 WRITE(6,281) (ICC(J),J=1,10)
0072 281 FORMAT(2X,'INT. OPER. CAP.',4X,10F10.0)
0073 WRITE(6,282) (TCI(J),J=1,10)
0074 282 FORMAT(1X,'TOTAL COTTONSEED COST',F9.0,9F10.0)
0075 210 K=0
0076 NK=0
0077 C N(3) IS THE CONTROL CHARACTER FOR INCLUDING OFFICE AS A
    COST CENTER
0078 IF (N(3).EQ.1) K=+1
0079 IF (N(3).EQ.1) NK=NK+1
0080 IF (N(3).NE.1) GO TO 300
C SUBROUTINE STAGE SUMMARIES THE VARIABLE COST ITEMS FOR USE IN THIS
    SECTION OF THE MODEL
0081 CALL STAGE
0082 DO 310 J=1,10
0083 VCL(K,J)=(PLAB(K)*(DP(J)*.14281)+(RLAB(K)*(DD(J)*.14281))+
    *(DLAB(K)*(DF(J)*.4281)
0084 VCE(K,J)=(ELEM*.6)
0085 VCM(K,J)=(TMS(K))*CAP(J)

```

```

0086 VCA(K,J)=(TANL(K)*CAP(J))
0087 TPC(K,J)=VCL(K,J)+VCE(K,J)+VCM(K,J)+VCA(K,J)
0088 IOC(K,J)=TPC(K,J)*((DP(J)/365)*TPSI)*RS)
0089 TPSC(K,J)=TPC(K,J)+IOC(K,J)
0090 APSC(K,J)=TPSC(K,J)/CAP(J)
0091 APFC(K,J)=PFC(K)/CAP(J)
0092 AC(K,J)=APSC(K,J)+APFC(K,J)
0093 310 CONTINUE
C N(4) IS THE CONTROL CHARACTER FOR INCLUDING UNLOADING AS A
C COST CENTER
0094 300 IF (N(4).EQ.1) K= +1
0095 IF (N(4).EQ.1) NK=NK+1
0096 IF (N(4).NE.1) GO TO 320
0097 CALL STAGE
0098 DO 330 J=1,10
0099 VCL(K,J)=PLAB(K)*(DU(J)*.1428)
0100 HRS(K,J)=(CAP(J)/RK)*TIME(K)
0101 VCE(K,J)=((TCHP(K)/UF)*.7457)*(HFS(K,J)*ELER)+((TCHP(K)/TCH1)
1*ELEM)
0102 VCR(K,J)=(PREP(K)*TMR)*CAP(J)
0103 VCF(K,J)=(TFUEL(K)*CAP(J))
0104 VCM(K,J)=(THS(K)*CAP(J))
0105 TPC(K,J)=VCL(K,J)+VCE(K,J)+VCM(K,J)+VCR(K,J)+VCF(K,J)
0106 IOC(K,J)=TPC(K,J)*((DP(J)/365)*TPSI)*RS)
0107 TPSC(K,J)=TPC(K,J)+IOC(K,J)
0108 APSC(K,J)=TPSC(K,J)/CAP(J)
0109 APFC(K,J)=PFC(K)/CAP(J)
0110 AC(K,J)=APSC(K,J)+APFC(K,J)
0111 330 CONTINUE
C N(5) IS THE CONTROL CHARACTER FOR INCLUDING COTTONSEED STORAGE
C AS A COST CENTER
0112 320 IF (N(5).EQ.1) K=K+1
0113 IF (N(5).EQ.1) NK=NK+1
0114 IF (N(5).NE.1) GO TO 340
0115 CALL STAGE
0116 DO 350 J=1,10
0117 VCL(K,J)=(PLAB(K)*(DP(J)*.1428)+(PLAB(K)*(DP(J)*.1428))*
*(DLAB(K)*(DF(J)*.1428))
VCE(K,J)=(TCHP(K)*.7457)*((TIME(K)*DP(J))*ELER)+((TCHP(K)/TCH1)
**ELEM)
0119 VCR(K,J)=(PREP(K)*TMR)*CAP(J)
0120 VCF(K,J)=(TFUEL(K)*CAP(J))
0121 VCM(K,J)=(THS(K)*CAP(J))
0122 VCI(K,J)=((TCC(J)*.0833)*.001)*VINR
0123 TPC(K,J)=VCL(K,J)+VCE(K,J)+VCM(K,J)+VCI(K,J)+VCR(K,J)+VCF(K,J)
0124 IOC(K,J)=TPC(K,J)*((DP(J)/365)*TPSI)*RS)
0125 TPSC(K,J)=TPC(K,J)+IOC(K,J)
0126 APSC(K,J)=TPSC(K,J)/CAP(J)
0127 APFC(K,J)=PFC(K)/CAP(J)
0128 AC(K,J)=APSC(K,J)+APFC(K,J)
0129 350 CONTINUE
C N(6) IS THE CONTROL CHARACTER WHICH SHOWS THE NUMBER OF COST
C CENTERS OF THE MILL WHICH ARE ACTUAL PROCESSING STEPS. THESE INCLUDE
C THOSE STAGES BETWEEN CLEANING AND EXTRACTION.
0130 340 NP=N(6)
0131 DO 400 M=1,NP
0132 K=K+1
0133 NK=NK+1

```

```

0134 CALL STAGE
0135 DO 700 J=1,10
0136 270 FORMAT(/,1X,'COST CENTER ',544)
0137 VCL(K,J)=(PLAB(K)*(DP(J)*.1428)+(PLAB(K)*(DP(J)*.1428))
**DLAB(K)*(DF(J)*.1428))
0138 60 FORMAT(1X,'LABOR',15X,10F10.0)
0139 VCE(K,J)=(TCHP(K)*.7457)*((TIME(K)*ELER)*DP(J))+((TCHP(K)/TCH1)*
*ELEM)
0140 70 FORMAT(1X,'ELECTRICITY',9X,10F10.0)
0141 VCF(K,J)=(TFUEL(K)*CAP(J))
0142 IF (TWT1.EQ.0) GO TO 330
0143 VCM(K,J)=(TWR(K)/TWT1)*TCWT(J)
0144 71 FORMAT(1X,'WATER',15X,10F10.0)
0145 333 VCB(K,J)=(TBAG(K)*CAP(J))
0146 72 FORMAT(1X,'BAGGING -TIES',8X,10F10.0)
0147 VCH(K,J)=(THX(K)*CAP(J))
0148 73 FORMAT(1X,'SOLVENT',13X,10F10.0)
0149 VCA(K,J)=(TANL(K)*CAP(J))
0150 74 FORMAT(1X,'LAB ANALYSIS',8X,10F10.0)
0151 VCR(K,J)=(PREP(K)*TMR)*CAP(J)
0152 VCM(K,J)=(THS(K)*CAP(J))
0153 75 FORMAT(1X,'MISCELLANEOUS',7X,10F10.0)
0154 TPC(K,J)=VCL(K,J)+VCE(K,J)+VCM(K,J)+VCR(K,J)+VCF(K,J)+
*VCH(K,J)+VCA(K,J)+VCR(K,J)+VCF(K,J)
IOC(K,J)=TPC(K,J)*((DP(J)/365)*TPSI)*RS)
0155 TPSC(K,J)=TPC(K,J)+IOC(K,J)
0156 57 FORMAT(1X,'INSURANCE',11X,10F10.0)
0157 76 FORMAT(1X,'TOTAL P.S. COST',5X,10F10.0)
0158 56 FORMAT(2X,'INT. OPER. CAP.',4X,10F10.0)
0159 55 FORMAT(1X,'TOTAL LESS INTEREST',1X,10F10.0)
0160 APSC(K,J)=TPSC(K,J)/CAP(J)
0161 APFC(K,J)=PFC(K)/CAP(J)
0162 AC(K,J)=APSC(K,J)+APFC(K,J)
0163 AREV(J)=TREV(J)/CAP(J)
0164 PC(K,J)=PFC(K)+TPSC(K,J)
0165 700 CONTINUE
0166 501 FORMAT(1X,'FUEL',15X,10F10.0)
0167 502 FORMAT(1X,'REPAIRS',13X,10F10.0)
0169 400 CONTINUE
C N(7) IS THE CONTROL CHARACTER FOR INCLUDING OIL STORAGE.
C AS A COST CENTER
0170 IF (N(7).EQ.1) K= +1
0171 IF (N(7).EQ.1) NK=NK+1
0172 IF (N(7).NE.1) GO TO 410
0173 CALL STAGE
0174 DO 420 J=1,10
0175 VCL(K,J)=(PLAB(K)*(DP(J)*.1428)+(PLAB(K)*(DP(J)*.1428))*
*(DLAB(K)*(DF(J)*.1428))
VCE(K,J)=(TCHP(K)*.7457)*((TIME(K)*DP(J))*ELER)+((TCHP(K)/TCH1)
**ELEM)
0176 VCR(K,J)=(PREP(K)*TMR)*CAP(J)
0177 VCF(K,J)=(TFUEL(K)*CAP(J))
0178 VCM(K,J)=(THS(K)*CAP(J))
0179 VCI(K,J)=((TCC(J)*.0833)*.001)*VINR
0180 TPC(K,J)=VCL(K,J)+VCE(K,J)+VCM(K,J)+VCI(K,J)+VCR(K,J)+VCF(K,J)
0181 IOC(K,J)=TPC(K,J)*((DP(J)/365)*TPSI)*RS)
0182 TPSC(K,J)=TPC(K,J)+IOC(K,J)
0183 APSC(K,J)=TPSC(K,J)/CAP(J)
0184

```

```

0185     APFC(K,J)=PFC(K)/CAP(J)
0186     AC(K,J)=APSC( ,J)+APFC(K,J)
0187     420 CONTINUE
      C N(8) IS THE CONTROL CHARACTER FOR INCLUDING MEAL STORAGE
      C AS A COST CENTER
0188     410 IF (N(8).EQ.1) K=K+1
0189           IF (N(8).EQ.1) NK=NK+1
0190           IF (N(8).NE.1) GO TO 420
0191           CALL STAGE
0192           DO 440 J=1,1
0193           VCL(K,J)=(PLAB(K)*(DP(J)*.1428))+(RLAB(K)*(DD(J)*.1428))+
      *(DLAB(K)*(DF(J)*.1428))
0194           VCE(K,J)=(TCHP(K)*.7457)*((TIME(K)*DP(J))*ELER)+((TCHP(K)/TCH1)
      **ELEM)
0195           VCR(K,J)=(PREP(K)*TMR)*CAP(J)
0196           VCF(K,J)=(TFUEL(K)*CAP(J))
0197           VCM(K,J)=(TMS(K)*CAP(J))
0198           VCI(K,J)=(((REVH/CAP)*CAP(J)*.083)*.001)*VINR
0199           TPC(K,J)=VCL(K,J)+VCE(K,J)+VCM(K,J)+VCI(K,J)+VCR(K,J)+VCF(K,J)
0200           IOC(K,J)=TPC(K,J)*(((DP(J)/365)*TPSI)*RS)
0201           TPSC(K,J)=TPC(K,J)+IOC(K,J)
0202           APSC(K,J)=TPSC(K,J)/CAP(J)
0203           APFC(K,J)=PFC(K)/CAP(J)
0204           AC(K,J)=APSC( ,J)+APFC(K,J)
0205     440 CONTINUE
      C N(9) IS THE CONTROL CHARACTER FOR INCLUDING HULL STORAGE
      C AS A COST CENTER
0206     430 IF (N(9).EQ.1) K= +1
0207           IF (N(9).EQ.1) NK=NK+1
0208           IF (N(9).NE.1) GO TO 450
0209           CALL STAGE
0210           DO 460 J=1,10
0211           VCL(K,J)=(PLAB(K)*(DP(J)*.1428))+(RLAB(K)*(DD(J)*.1428))+
      *(DLAB(K)*(DF(J)*.1428))
0212           VCE(K,J)=(TCHP(K)*.7457)*((TIME(K)*DP(J))*ELER)+((TCHP(K)/TCH1)
      **ELEM)
0213           VCR(K,J)=(PREP(K)*TMP)*CAP(J)
0214           VCF(K,J)=(TFUEL(K)*CAP(J))
0215           VCM(K,J)=(TMS(K)*CAP(J))
0216           VCI(K,J)=(((REVH/TCAP)*CAP(J)*.083)*.001)*VINR
0217           TPC(K,J)=VCL(K,J)+VCE(K,J)+VCM(K,J)+VCI(K,J)+VCR(K,J)+VCF(K,J)
0218           IOC(K,J)=TPC(K,J)*(((DP(J)/365)*TPSI)*RS)
0219           TPSC(K,J)=TPC(K,J)+IOC(K,J)
0220           APSC(K,J)=TPSC(K,J)/CAP(J)
0221           APFC(K,J)=PFC(K)/CAP(J)
0222           AC(K,J)=APSC( ,J)+APFC(K,J)
0223     460 CONTINUE
      C N(10) IS THE CONTROL CHARACTER FOR INCLUDING LINTERS STORAGE
      C AS A COST CENTER
0224     450 IF (N(10).EQ.1) K=K+1
0225           IF (N(10).EQ.1) NK=NK+1
0226           IF (N(10).NE.1) GO TO 470
0227           CALL STAGE
0228           DO 480 J=1,10
0229           VCL(K,J)=(PLAB(K)*(DP(J)*.1428))+(RLAB(K)*(DD(J)*.1428))+
      *(DLAB(K)*(DF(J)*.1428))
0230           VCE(K,J)=(TCHP(K)*.7457)*((TIME(K)*DP(J))*ELER)+((TCHP(K)/TCH1)
      **ELEM)

```

```

0231     VCR(K,J)=(PREP(K)*TMR)*CAP(J)
0232     VCF(K,J)=(TFUEL(K)*CAP(J))
0233     VCM(K,J)=(TMS(K)*CAP(J))
0234     VCI(K,J)=(((TRL/TAP)*CAP(J)*.083)*.001)*VINR
0235     TPC(K,J)=VCL(K,J)+VCE(K,J)+VCM(K,J)+VCI(K,J)+VCR(K,J)+VCF(K,J)
0236     IOC(K,J)=TPC(K,J)*(((DP(J)/365)*TPSI)*RS)
0237     TPSC(K,J)=TPC(K,J)+IOC(K,J)
0238     APSC(K,J)=TPSC(K,J)/CAP(J)
0239     APFC(K,J)=PFC(K)/CAP(J)
0240     AC(K,J)=APSC( ,J)+APFC(K,J)
0241     480 CONTINUE
0242     IF (N(11).NE.1) GO TO 200
0243     DO 121 K=1,NK
0244     WRITE(6,270) (TITLE(K,I),I=1,5)
0245     IF (VCL(K,1).GT.0) WRITE(6,60) (VCL(K,J),J=1,10)
0246     IF (VCE(K,1).GT.0) WRITE(6,70) (VCE(K,J),J=1,10)
0247     IF (VCR(K,1).GT.0) WRITE(6,502) (CR(K,J),J=1,10)
0248     IF (VCA(K,1).GT.0) WRITE(6,74) (VCA(K,J),J=1,10)
0249     IF (VCB(K,1).GT.0) WRITE(6,72) (VCB(K,J),J=1,10)
0250     IF (VCF(K,1).GT.0) WRITE(6,501) (VCF(K,J),J=1,10)
0251     IF (VCM(K,1).GT.0) WRITE(6,75) (VCM(K,J),J=1,10)
0252     IF (VCH(K,1).GT.0) WRITE(6,73) (VCH(K,J),J=1,10)
0253     IF (VCI(K,1).GT.0) WRITE(6,57) (VCI(K,J),J=1,10)
0254     IF (VCH(K,1).GT.0) WRITE(6,71) (VCH(K,J),J=1,10)
0255     WRITE(6,55) (TPC( ,J),J=1,10)
0256     WRITE(6,56) (IOC(K,J),J=1,10)
0257     WRITE(6,76) (TPSC(K,J),J=1,10)
0258     121 CONTINUE
0259     200 DO 35 J=1,10
0260     ACC(J)=TCC(J)*(1/CAP(J))
0261     ATC(J)=TCC(J)*(1/AP(J))
0262     ACI(J)=TCI(J)*(1/CAP(J))
0263     TVC(J)=0.0
0264     TVC(J)=TVC(J)+TCI(J)
0265     TVCL(J)=0.0
0266     TVCE(J)=0.0
0267     TVCR(J)=0.0
0268     TVCM(J)=0.0
0269     TVCH(J)=0.0
0270     TVCA(J)=0.0
0271     TVCB(J)=0.0
0272     TVCI(J)=0.0
0273     TVCF(J)=0.0
0274     TVCH(J)=0.0
0275     35 CONTINUE
0276     IF (N(12).NE.1) GO TO 211
0277     WRITE(6,284) (CL(J),J=1,10)
0278     294 FORMAT(///30X,'AVERAGE VARIABLE COST BY ITEM BY COST',
      *' CENTER'//1X,'UTILIZATION LEVEL',9X,F4.0,'%',9(F9.0,'%'))
0279     WRITE(6,286) (ACC(J),J=1,10)
0280     286 FORMAT(//1X,'COTTONSEED BUY',1X,
      *'COTTONSEED COST' 5X,10F10.2)
0281     WRITE(6,287) (ATC(J),J=1,10)
0282     287 FORMAT(2X,'IN . O R . CAP.',4X,10F10.2)
0283     WRITE(6,288) (ACI(J),J=1,10)
0284     288 FORMAT(1X,'AVER. .S. CCST',5X,10F10.2)
0285     211 DO 37 J=1,10
0286     DO 36 K=1,NK

```

```

0287 36 TVC(J)=TVC(J)+TPSC(K,J)
0288 37 CONTINUE
0289 DD 39 K=1,NK
0290 DD 38 J=1,10
0291 AVCL(K,J)=VCL(K,J)*(1/CAP(J))
0292 AVCE(K,J)=VCE(K,J)*(1/CAP(J))
0293 AVCR(K,J)=VCR(K,J)*(1/CAP(J))
0294 AVCM(K,J)=VCM(K,J)*(1/CAP(J))
0295 AVCA(K,J)=VCA(K,J)*(1/CAP(J))
0296 AVCB(K,J)=VCB(K,J)*(1/CAP(J))
0297 AVCF(K,J)=VCF(K,J)*(1/CAP(J))
0298 AVCI(K,J)=VCI(K,J)*(1/CAP(J))
0299 AVCH(K,J)=VCH(K,J)*(1/CAP(J))
0300 AVCG(K,J)=VCG(K,J)*(1/CAP(J))
0301 AIOC(K,J)=IOC(K,J)*(1/CAP(J))
0302 TVCL(J)=TVCL(J)+A CL(K,J)
0303 TVCE(J)=TVCE(J)+A CE(K,J)
0304 TVCR(J)=TVCR(J)+AVCR(K,J)
0305 TVCA(J)=TVCA(J)+A CA(K,J)
0306 TVCB(J)=TVCB(J)+AVCB(K,J)
0307 TVCF(J)=TVCF(J)+A CF(K,J)
0308 TVCM(J)=TVCM(J)+AVCM(K,J)
0309 TVCH(J)=TVCH(J)+A CH(K,J)
0310 TVCI(J)=TVCI(J)+AVCI(K,J)
0311 TVCH(J)=TVCH(J)+A CW(K,J)
0312 38 CONTINUE
0313 IF (N(12).NE.1) GO TO 470
0314 WRITE(6,270) (TITLE(K,I),I=1,5)
0315 IF (VCL(K,1).GT.0) WRITE(6,999) (AVCL(K,J),J=1,10)
0316 999 FORMAT(1X,'LABOR',15X,10F10.2)
0317 IF (VCE(K,1).GT.0) WRITE(6,998) (AVCE(K,J),J=1,10)
0318 998 FORMAT(1X,'ELECTR CITY',9X,10F10.2)
0319 IF (VCR(K,1).GT.0) WRITE(6,997) (AVCR(K,J),J=1,10)
0320 997 FORMAT(1X,'REPAIRS',13X,10F10.2)
0321 IF (VCA(K,1).GT.0) WRITE(6,996) (AVCA(K,J),J=1,10)
0322 996 FORMAT(1X,'LAB ANALYSIS',8X,10F10.2)
0323 IF (VCB(K,1).GT.0) WRITE(6,995) (AVCB(K,J),J=1,10)
0324 995 FORMAT(1X,'BAGGING-TIES',8X,10F10.2)
0325 IF (VCF(K,1).GT.0) WRITE(6,994) (AVCF(K,J),J=1,10)
0326 994 FORMAT(1X,'FUEL', 6X,10F10.2)
0327 IF (VCM(K,1).GT.0) WRITE(6,993) (AVCM(K,J),J=1,10)
0328 993 FORMAT(1X,'MISCELLANEOUS',7X,10F10.2)
0329 IF (VCH(K,1).GT.0) WRITE(6,992) (AVCH(K,J),J=1,10)
0330 992 FORMAT(1X,'SOLVENT',13X,10F10.2)
0331 IF (VCI(K,1).GT.0) WRITE(6,991) (AVCI(K,J),J=1,10)
0332 991 FORMAT(1X,'INSURANCE',11X,10F10.2)
0333 IF (VCH(K,1).GT.0) WRITE(6,989) (AVCH(K,J),J=1,10)
0334 989 FORMAT(1X,'WATER',15X,10F10.2)
0335 WRITE(6,988) (AIO(K,J),J=1,10)
0336 988 FORMAT(2X,'INT. OPER. CAP.',4X,10F10.2)
0337 WRITE(6,987) (APSC(K,J),J=1,10)
0338 987 FORMAT(1X,'AVER. .S. COST',5X,10F10.2)
0339 39 CONTINUE
0340 IF (N(13).NE.1) GO TO 470
0341 WRITE(6,802)
0342 802 FORMAT(/////20X,'AVERAGE VARIABLE CCST BY RESOURCE ITEM',
* PROCESSED'//)
0343 WRITE(6,999) (TVCL(J),J=1,10)

```

```

0344 WRITE(6,998) (TVCE(J),J=1,10)
0345 WRITE(6,997) (TVCR(J),J=1,10)
0346 WRITE(6,996) (TVCA(J),J=1,10)
0347 WRITE(6,995) (TVCB(J),J=1,10)
0348 WRITE(6,994) (TVCF(J),J=1,10)
0349 WRITE(6,993) (TVCM(J),J=1,10)
0350 WRITE(6,992) (TVCH(J),J=1,10)
0351 WRITE(6,991) (TVCI(J),J=1,10)
0352 WRITE(6,989) (TVCG(J),J=1,10)
0353 470 DD 750 J=1,1)
0354 TC(J)=0.0
0355 TNR(J)=0.0
0356 AFC(J)=0.0
0357 AVC(J)=0.0
0358 ATC(J)=0.0
0359 ANF(J)=0.0
0360 TC(J)=TVCL(J)+TFC
0361 TNR(J)=TPEV(J)-TC(J)
0362 AFC(J)=TFC/CA (J)
0363 AVC(J)=TVC(J)/CAP(J)
0364 ATC(J)=TC(J)/CAP(J)
0365 ANR(J)=TNR(J)/CAP(J)
0366 750 CONTINUE
0367 WRITE(6,83)
0368 33 FORMAT(/////30X,'COST CENTER AVERAGE FIXED COSTS',//)
0369 WRITE(6,751) (CL(J),J=1,10)
0370 751 FORMAT(1X,'UTILIZATION LEVEL',8X,F4.0,'%',9(F9.0,'%'))
0371 DD 600 K=1,NK
0372 WRITE(6,78) (TITLE(K,I),I=1,5),(APFC(K,J),J=1,10)
0373 78 FORMAT(1X,5A+,10F10.2)
0374 600 CONTINUE
0375 WRITE(6,84)
0376 84 FORMAT(/////30X,'COST CENTER AVERAGE VARIABLE COSTS',//)
0377 WRITE(6,751) (CL(J),J=1,10)
0378 DC 800 K=1,NK
0379 WRITE(6,77) (TITLE(K,I),I=1,5),(APSC(K,J),J=1,10)
0380 77 FORMAT(1X,5A+,10F10.2)
0381 800 CONTINUE
0382 WRITE(6,85)
0383 85 FORMAT(/////30X,'COST CENTER AVERAGE TOTAL COSTS',//)
0384 WRITE(6,751) (CL(J),J=1,10)
0385 DD 900 K=1,NK
0386 WRITE(6,86) (TITLE(K,I),I=1,5),(AC(K,J),J=1,10)
0387 86 FORMAT(1X,5A+,10F10.2)
0388 900 CONTINUE
0389 WRITE(6,91) (CL(J),J=1,10),TFC
0390 91 FORMAT(/////30X,'TOTAL COSTS AND RETURNS MATRIX',///1X,
*UTILIZATION LEVEL',9X,F4.0,'%',9(F9.0,'%')/1X,'TOTAL FIXED CCST'
*,4X,F10.0)
0391 WRITE(6,92) (TVC(J),J=1,10)
0392 92 FORMAT(1X,'TOTAL VAR. COST',5X,10F10.0)
0393 WRITE(6,93) (TC(J),J=1,10)
0394 93 FORMAT(1X,'TOTAL CGST',10X,10F10.0)
0395 WRITE(6,79) (TREV(J),J=1,10)
0396 79 FORMAT(1X,'TOTAL REVENUE',7X,10F10.0)
0397 WRITE(6,95) (TNR(J),J=1,10)
0398 95 FORMAT(1X,'TOTAL NET REVENUE',3X,10F10.0)
0399 WRITE(6,61) (CL(J),J=1,10)

```

```

0400 61 FORMAT(/////30X,'AVERAGE COST AND RETURNS MATRIX',//
      *1X,'UTILIZATION LEVEL',8X,F4.0,'%',9(F9.0,'%'))
0401 WRITE(6,96) (AFC(J),J=1,10)
0402 96 FORMAT(1X,'AVER. FIXED COST',4X,10F10.2)
0403 WRITE(6,97) (AVC(J),J=1,10)
0404 97 FORMAT(1X,'AVER. VAR. COST',5X,10F10.2)
0405 WRITE(6,98) (ATC(J),J=1,10)
0406 98 FORMAT(1X,'AVER. TOTAL COST',4X,10F10.2)
0407 WRITE(6,99) (AREV(J),J=1,10)
0408 99 FORMAT(1X,'AVER. REVENUE',7X,10F10.2)
0409 WRITE(6,100) (ANR(J),J=1,10)
0410 100 FORMAT(1X,'AVER. NET REVENUE',3X,10F10.2//////////)
0411 STOP
0412 END

```

FIX

```

0001 SUBROUTINE FIX(TFC)
0002 COMMON N(13),PCS,R,RS, CPP,CAP(13),DP(10),DD(10),PFC(20),TCAP,K,
      *TINT(20),TDEP(20),TCHP(20),TREP(20),TWTR(20),DF(10),TREV(10),
      *TDEL,TIN1,TRP1,TCH1,TWT1,TTAX(20),TINS(20),CL(10),NPD(10),TND(20)
      *,PREP(20),T3AG(20),TANL(20),TFUEL(20),UF,
      *THEX(20),PLAB(20),RLAB(20),DLAB(20),TMIS(20),TITLE(20,5)
      *,TSURE(20),REV0,REVM,REVM,REVM,TRL,HRST(20,10),TRK,TIME(20)
      INTEGER F/'F'/,C/'C'/,E/'E'/,L/'L'/,A/'A'/
      INTEGER NAME(5),NUM,YRS,ID
      REAL FOB,INST,REP,SAL,CHP,WTR,INT,INS,INSR
      READ(5,200) TAXR,INSR
0006 200 FORMAT(2F5.0)
0007 TDE1=0.0
0008 TND=0.0
0009 TIN1=0.0
0010 TRP1=0.0
0011 TCH1=0.0
0012 TWT1=0.0
0013 TTX1=0.0
0014 TIS1=0.0
0015 TFC=0.0
0016 K=0
0017 NK=0
0018 WRITE(6,10)
0019 10 FORMAT(/////30X,'FIXED COST BY ITEM BY COST CENTER'///)
0020 AEC=0.0
0021 FOB1=0.0
0022 SAL1=0.0
0023 REPI=0.0
0024 DEPI=0.0
0025 INT=0.0
0026 AEC1=0.0
0027 READ(5,20) ID,(NAME(I),I=1,5),=CB,NUM,YRS,INST,REP,SAL,CHP,WTR
0028 20 FORMAT(A1,5A4,F9.0,I5,I2,F5.0,3F4.0,F8.0)
0029 IF (ID.EQ.F) GO TO 60
0030 IF (ID.EQ.A) GO TO 60
0031 IF (ID.EQ.C) GO TO 70
0032 IF (ID.EQ.E) GO TO 80
0033

```

```

0034 IF (ID.EQ.L.AND.K.EQ.0) WRITE(6,30) (NAME(I),I=1,5)
0035 30 FORMAT(/1X,'COST CENTER',16X,'UNIT',3X,'NUM',1X,'YRS',3X,
      *SALVAGE',25X,'FIXED',24X,'NON-DEPR',9X,'ANNUAL'/1X,5A4,6X,'VALUE'
      *,2X,'UNIT',1X,'LIFE',4X,'VALUE',6X,'DEPR',2X,'INTEREST',4X,
      *REPAIR',5X,'TAXES',4X,'INSURE',8X,'CCST',11X,'COST')
0036 IF (ID.EQ.L.AND.K.GT.0) WRITE(6,40) TDEP(K),TINT(K),TREP(K),
      *TTAX(K),TINS(K),TND(K),PFC(K),(NAME(I),I=1,5)
0037 40 FORMAT(1X,'TOTAL COSTS',40X,5F10.2,F12.2,F15.2,///1X,
      *COST CENTER',16X,'UNIT',3X,'NUM',1X,'YRS',3X,'SALVAGE',25X,
      *FIXED',24X,'NON-DEPR',9X,'ANNUAL'/1X,5A4,6X,'VALUE',2X,'UNIT',1X,
      *LIFE',4X,'VALUE',6X,'DEPR',2X,'INTEREST',4X,'REPAIR',5X,'TAXES',
      *4X,'INSURE',3X,'COST',11X,'CCST')
0038 IF (K.EQ.0) GO TO 5
0039 TDE1=TDE1+TDEP(K)
0040 TND=TND+TND(K)
0041 TIN1=TIN1+TINT(K)
0042 TRP1=TRP1+TREP(K)
0043 TFC=TFC+PFC(K)
0044 TCH1=TCH1+TCHP(K)
0045 TWT1=TWT1+TWT(K)
0046 TTX1=TTX1+TTAX(K)
0047 TIS1=TIS1+TINS(K)
0048 5 K=K+1
0049 NK=NK+1
0050 TDEP(K)=0.0
0051 TND(K)=0.0
0052 TINT(K)=0.0
0053 TREP(K)=0.0
0054 PFC(K)=0.0
0055 TCHP(K)=0.0
0056 TWTR(K)=0.0
0057 TTAX(K)=0.0
0058 TINS(K)=0.0
0059 GO TO 50
0060 60 FOB1=0.0
0061 SAL1=0.0
0062 AEC1=0.0
0063 REPI=0.0
0064 DEPI=0.0
0065 INT=0.0
0066 TAX=0.0
0067 INS=0.0
0068 SAL1=FOB*NUM*SAL
0069 FOB1=(FOB*NUM)*(1+INST)
0070 AEC1=((FOB1*(R*((1+R)**YRS)))/(((1+R)**YRS)-1))-((SAL1*R)/(((1+R)
      **YRS)-1))
0071 TAX=(FOB1/100)*TAXR
0072 INS=(FOB1/100)*INSR
0073 IF (ID.EQ.A) INS=0.0
0074 REPI=FOB*NUM*REP
0075 DEPI=(FOB1-SAL1)/YRS
0076 INT=AEC1-DEPI
0077 AEC=AEC1+REPI+TAX+INS
0078 WRITE(6,90) (NAME(I),I=1,5),FOB,NUM,YRS,SAL1,DEPI
      *,INT,REPI,TAX,INS,AEC
0079 90 FORMAT(1X,5A4,F11.2,I6,I4,6F10.2,12X,F15.2)
0080 120 IF (ID.EQ.C) DEPI=0.0
0081 TDEP(K)=TDEP(K)+DEPI

```

```

0082      TINT(K)=TINT(K)+INT
0083      IF (ID.EQ.C) REP1=0.0
0084      TREP(K)=TREP(K)+REP1
0085      PFC(K)=PFC(K)+AEC
0086      IF (ID.EQ.C) CHP=0.0
0087      TCHP(K)=TCHP(K)+CHP
0088      IF (ID.EQ.C) WTR=0.0
0089      TWTR(K)=TWTR(K)+WTR
0090      IF (ID.EQ.C) TAX=0.0
0091      TTAX(K)=TTAX(K)+TAX
0092      IF (ID.EQ.C) INS=0.0
0093      TINS(K)=TINS(K)+INS
0094      GO TO 50
0095      70 AEC1=FOB*NUM
0096      TND(K)=TND(K)+AEC1
0097      AEC=(FOB*NUM)*(1+(RS*.5))
0098      INT=AEC-AEC1
0099      WRITE(6,100) (NAME(I),I=1,5),FOB,NU4,INT,AEC1,AEC
0100      100 FORMAT(1X,5A1,F11.2,F16.2,4X,F10.2,30X,F12.2,F15.2)
0101      GO TO 120
0102      80 TDE1=TDE1+TDEP(K)
0103      TNDC=TNDC+TND(K)
0104      TIN1=TIN1+TINT(K)
0105      TRP1=TRP1+TRP(K)
0106      TFC=TFC+PFC(K)
0107      TCH1=TCH1+TCHP(K)
0108      TWTR1=TWTR1+TWTR(K)
0109      TTX1=TTX1+TTAX(K)
0110      TIS1=TIS1+TINS(K)
0111      WRITE(6,130) TDEP(K),TINT(K),TREP(K),
*TTAX(K),TINS(K),TND(K),PFC(K)
0112      130 FORMAT(1X,'TOTAL CUST',4X,5F10.2,F12.2,F15.2)
0113      WRITE(6,110) TDE1,TIN1,TRP1,TTX1,TIS1,TNDC,TFC
0114      110 FORMAT(1X,'TOTAL FIXED COSTS',3X,5F10.2,F12.2,F15.2)
0115      RETURN
0116      END

```

```

0007      10 FORMAT(//////////20X,'TOTAL REVENUE AT 100% CAPACITY UTILIZATION')
0008      TRL=0.0
0009      TR=0.0
0010      20 READ(5,30) ID,NUM,PR
0011      30 FORMAT(A1,F9.0,F10.0)
0012      IF (ID.EQ.M) GO TO 40
0013      IF (ID.EQ.H) GO TO 60
0014      IF (ID.EQ.L) GO TO 70
0015      IF (ID.EQ.E) GO TO 90
0016      REVO=(TCAP*NUM)*PR
0017      TR=REVO+TR
0018      WRITE(6,50) REVO
0019      50 FORMAT(//,5X,'REVENUE FROM OIL SALES',20X,F15.2)
0020      GO TO 20
0021      40 REVM=((TCAP*NUM)/2000)*PR
0022      TR=REVM+TR
0023      WRITE(6,51) REVM
0024      51 FORMAT(5X,'REVENUE FROM MEAL SALES',19X,F15.2)
0025      GO TO 20
0026      60 REVM=((TCAP*NUM)/2000)*PR
0027      TR=REVM+TR
0028      WRITE(6,52) REVM
0029      52 FORMAT(5X,'REVENUE FROM HULL SALES',19X,F15.2)
0030      GO TO 20
0031      70 REVL=0.0
0032      REVL=(TCAP*NUM)*PR
0033      TRL=REVL+TR
0034      GO TO 20
0035      90 TR=TR+TR
0036      WRITE(6,53) TRL
0037      53 FORMAT(5X,'REVENUE FROM LINTER SALES',17X,F15.2)
0038      WRITE(6,54) TR
0039      54 FORMAT(1X,'TOTAL REVENUE',24X,F20.2)
0040      RETURN
0041      END

```

75

NR

```

0001      SUBROUTINE NR(TR)
0002      COMMON N(13),PCS,R,RS,CPP,CAP(1),DP(10),DD(10),PFC(20),TCAP,K,
*TINT(20),TDEP(20),TCHP(20),TREP(20),TWTR(20),DF(10),TREV(10),
*TDE1,TIN1,TRP1,TCH1,TWT1,TTAX(20),TINS(20),CL(10),NPD(10),TND(20)
*,PREP(20),TBAG(20),TANL(20),TFUEL(20),UF,
*THEX(20),PLA3(20),RLAB(20),DLA3(20),TMIS(20),TITLE(20,5)
*,TSURE(20),REVO,REVM,REVM,TRL,HRS(20,10),TRK,TIME(20)
INTEGER E/'E'/'S'/'U'/'T'/'L'/'
REAL NUM,PR
TR=0.0
WRITE(6,10)

```

STAGE

```

0001      SUBROUTINE STAGE
0002      COMMON N(13),PCS,R,RS,CPP,CAP(1),DP(10),DD(10),PFC(20),TCAP,K,
*TINT(20),TDEP(20),TCHP(20),TREP(20),TWTR(20),DF(10),TREV(10),
*TDE1,TIN1,TRP1,TCH1,TWT1,TTAX(20),TINS(20),CL(10),NPD(10),TND(20),
*PREP(20),TBAG(20),TANL(20),TFUEL(20),UF,
*THEX(20),PLA3(20),RLAB(20),DLA3(20),TMIS(20),TITLE(20,5)
*,TSURE(20),REVO,REVM,REVM,TRL,HRS(20,10),TRK,TIME(20)
INTEGER A/'A'/'S'/'U'/'T'/'L'/'
M/'M'/'S'/'S'/'U'/'T'/'L'/'
REAL NUM1,NUM2,NUM3,PR
TBAG(K)=0.0
TFUEL(K)=0.0

```

```

0007      THEX(K)=0.0
0008      TANL(K)=0.0
0009      TMIS(K)=0.0
0010      TSURE(K)=0.0
0011      TIME(K)=0.0
0012      TRK=0.0
0013      PLAB(K)=0.0
0014      RLAB(K)=0.0
0015      CLAB(K)=0.0
0016      PREP(K)=0.0
0017      IF (TCHP(K).GT.0) PREP(K)=TCHP(K)/TCH1
0018      READ(5,15) (TITLE(K,I),I=1,5),TIME(K)
0019      15  FCRMAT(5A4,F10.0)
0020      IF (TIME(K).EQ.0.0) TIME(K)=24.
0021      10  PLBC=0.0
0022      RLBC=0.0
0023      DLBC=0.0
0024      NUM1=0.0
0025      NUM2=0.0
0026      NUM3=0.0
0027      PR=0.0
0028      READ(5,20) ID,PR,NUM1,NUM2,NUM3
0029      20  FORMAT(A1,F9.0,3F10.0)
0030      IF (ID.EQ.A) GO TO 30
0031      IF (ID.EQ.B) GO TO 40
0032      IF (ID.EQ.E) GO TO 100
0033      IF (ID.EQ.F) GO TO 50
0034      IF (ID.EQ.H) GO TO 60
0035      IF (ID.EQ.L) GO TO 70
0036      IF (ID.EQ.M) GO TO 80
0037      IF (ID.EQ.T) TRK=NUM1
0038      IF (ID.EQ.U) UF=N M1
0039      30  TANL(K)=TANL(K)+PR
0040      GO TO 10
0041      40  TBAG(K)=((NUM1+NUM2+NUM3)/600)*PR
0042      GO TO 10
0043      50  TFUEL(K)=NUM1*PR
0044      GO TO 10
0045      60  THEX(K)=THEX(K)+(NUM1*PP)
0046      GO TO 10
0047      70  PLBC=NUM1*PR
0048      PLAB(K)=PLAB(K)+PLBC
0049      RLBC=NUM2*PR
0050      RLAB(K)=RLAB(K)+RLBC
0051      DLBC=NUM3*PR
0052      DLAB(K)=DLAB(K)+DLBC
0053      GO TO 10
0054      80  TMIS(K)=TMIS(K)+PR
0055      GO TO 10
0056      100 RETURN
0057      END

```

Appendix VII

Computer Model Output From
the Example Data Set

*****COTTONSEED OIL MILL SIMULATION MODEL*****
 ECONOMICS, STATISTICS, AND COOPERATIVES SERVICE
 USDA AND TEXAS TECH UNIVERSITY

Section A COTTONSEED OIL MILL DESCRIPTION

AREA = SOUTH
 EXTRACTION TECHNOLOGY = SCREWPRESS
 PROCESSING CAPACITY = 100, TPD
 NUMBER OF DAYS PROCESSING AT FULL CAPACITY = 330. DAYS
 NUMBER OF DAYS FOR REPAIRS BETWEEN SEASONS = 35. DAYS

Section B FIXED COST BY ITEM BY COST CENTER

COST CENTER	UNIT VALUE	NUM YRS	SALVAGE VALUE	DEPR	INTEREST	FIXED REPAIR	TAXES	INSURE	NON-DEPR COST	ANNUAL COST
OFFICE										570.00
LAND	1000.00	5	5000.00	0.0	500.00	0.0	70.00	0.0	25000.00	5307.73
BUILDING	26.80	150	4020.00	904.50	3197.24	402.00	562.80	241.20	22000.00	26874.99
MILL MANAGER	25000.00	1			1874.99				22000.00	23649.99
MILL SUPT.	22000.00	1			1649.99				54000.00	58049.99
SHIFT SUPV.	18000.00	1			4389.99				96000.00	103199.94
FOREMEN	16000.00	1			7199.94				7500.00	8062.50
SECRETARIES	7500.00	1			562.50				204500.00	225715.06
TOTAL COSTS				904.50	19034.64	402.00	632.80	241.20		
COST CENTER UNLOADING SCALES	18852.00	1	1885.20	1476.74	3411.33	188.52	644.62	277.12		6003.33
TRUCKDUMP	56877.00	1	5687.70	5346.45	9447.52	568.77	1950.88	836.09		18649.69
TOTAL COSTS				6823.17	13358.84	757.29	2597.50	1113.22	0.0	24653.02
COST CENTER STORAGE SEEDHOUSE CONVEYORS	465750.00	1	92149.94	20956.75	74085.38	18630.00	13041.00	5589.00		132304.00
TOTAL COSTS	18880.00	1	0.0	2312.80	3120.42	0.0	0.0	0.0	0.0	6358.34
TOTAL COSTS				23271.55	77205.73	18630.00	13688.58	5866.54		138562.31
COST CENTER CLEANING BUILDING 2-TRAY SHAKERS CONVEYORS	13.50	1	2430.00	243.00	593.96	121.50	170.10	72.90		1601.46
TOTAL COSTS	29375.00	1	0.0	4523.75	9872.54	0.0	1899.97	814.27		17110.54
TOTAL COSTS	4720.00	1	0.0	578.20	790.11	0.0	181.90	69.38	0.0	1589.59
TOTAL COSTS				5244.95	11646.61	121.50	2231.97	956.56		20301.58
COST CENTER DELIVERING BUILDING DELINTERS GUNNER LINT FLUE SYS LINT ROBBING SYS LINT PICKUP SYS LINT CLEANER CONVEYORS	13.50	1	8100.00	810.00	3313.20	405.00	567.00	243.00		5338.19
TOTAL COSTS	14582.00	1	0.0	15719.39	34205.70	0.0	6602.14	2929.49		59454.72
TOTAL COSTS	15845.00	1	0.0	929.57	2028.68	0.0	390.42	167.32		3510.00
TOTAL COSTS	2500.00	1	0.0	352.22	813.19	50.00	85.75	36.75		891.94
TOTAL COSTS	3500.00	1	0.0	428.75	578.47	70.00	120.05	51.45		1248.72
TOTAL COSTS	3000.00	1	0.0	367.50	495.83	60.00	102.90	44.10		1070.33
TOTAL COSTS	24744.00	1	0.0	3810.57	3316.12	0.0	1600.44	685.90		14413.04
TOTAL COSTS	11060.00	1	0.0	1354.85	1827.96	221.20	377.36	162.58		3945.95
TOTAL COSTS				23726.87	51279.15	806.20	9848.04	4220.59		89880.75
COST CENTER BAILING BUILDING BALE PRESS	12.80	1	512.00	51.20	209.43	25.60	35.84	15.36		337.43
TOTAL COSTS	12173.00	1	0.0	7028.92	21722.02	0.0	3936.20	1686.94		34374.07
TOTAL COSTS				7080.12	21931.45	25.60	3972.04	1702.30	0.0	34711.50
COST CENTER HULL-SEP SAFETY SHAKER PURIFYING-HULLER DOUBLE DRUM BEATER H AND S MACHINE MEATS PULFIER TAILINGS BEATER NOTES BEATER CONVEYORS HULLS BLOWING SYS	8378.00	1	0.0	967.46	1325.56	0.0	270.94	116.12		2660.28
TOTAL COSTS	14993.00	2	0.0	2770.70	4860.38	0.0	969.75	415.61		9016.44
TOTAL COSTS	7333.00	2	0.0	1364.38	2392.40	0.0	477.53	204.66		4439.96
TOTAL COSTS	13250.00	1	0.0	1222.45	2144.43	0.0	427.86	183.37		3978.11
TOTAL COSTS	7378.00	1	0.0	681.73	1195.89	0.0	238.60	102.26		2218.48
TOTAL COSTS	11793.00	1	0.0	1089.67	1911.51	0.0	381.39	163.45		3545.02
TOTAL COSTS	7545.00	1	0.0	697.16	1222.96	0.0	244.01	104.57		2268.69
TOTAL COSTS	5395.00	1	0.0	458.53	874.47	0.0	174.47	74.77		1622.21
TOTAL COSTS	1260.00	1	0.0	194.04	188.63	0.0	40.75	17.46		440.88
TOTAL COSTS	10100.00	1	0.0	1555.40	1512.03	0.0	326.63	139.99		3534.04
TOTAL COSTS				11041.68	17609.23	0.0	3551.93	1522.26	0.0	33725.11
COST CENTER MEATS PREPARATION MEATS COND. BLDG. BOILER CRUSHING ROLLS 6-HIGH COOKER CONVEYORS	13.50	1	1620.00	162.00	662.64	81.00	113.40	48.60		1067.64
TOTAL COSTS	22700.00	1	0.0	1747.90	3614.58	0.0	734.12	314.62		6611.22
TOTAL COSTS	95040.00	1	0.0	7318.07	15970.83	0.0	2073.59	1317.25		27679.75
TOTAL COSTS	128400.00	1	0.0	9886.79	21576.76	0.0	4152.45	1779.62		37395.62
TOTAL COSTS	8873.00	1	0.0	1366.44	1328.34	0.0	286.95	122.98		3104.71
TOTAL COSTS				20481.21	43353.14	81.00	8360.50	3583.08	0.0	75898.88
COST CENTER EXTRACTION SCREWPRESS RACKET ELEV. SETTLING TANK FILTER PRESS PUMP-CONVEYORS	13900.00	1	0.0	17031.17	52632.70	0.0	9537.45	4087.48		83288.75
TOTAL COSTS	5300.00	1	0.0	645.25	875.97	53.00	181.79	77.91		1837.92
TOTAL COSTS	18000.00	1	0.0	2079.00	2804.98	180.00	582.12	249.48		5895.57
TOTAL COSTS	25450.00	1	0.0	1959.65	4276.70	0.0	823.05	352.74		7412.13
TOTAL COSTS	11850.00	1	0.0	1935.50	1881.53	118.50	406.45	174.19		4515.17
TOTAL COSTS				23654.56	62471.87	351.50	11533.86	4941.79	0.0	102950.44
COST CENTER OIL STORAGE TANKS PUMPS	12000.00	3	3600.00	3182.40	5642.57	360.00	1164.24	498.96		11148.16
TOTAL COSTS	3300.00	1	0.0	762.30	478.31	0.0	106.72	45.74		1393.07
TOTAL COSTS				3944.70	6420.88	360.00	1270.96	544.70	0.0	12541.23
COST CENTER MEAL STORAGE BUILDING	13.20	3150	4158.00	935.55	3307.00	415.80	582.12	249.48		5489.94
TOTAL COSTS				935.55	3307.00	415.80	582.12	249.48	0.0	5489.94
COST CENTER HULL STORAGE BUILDING	13.20	7800	10295.99	2316.60	8188.76	1029.60	1441.44	617.76		13594.15
TOTAL COSTS				2316.60	8188.76	1029.60	1441.44	617.76	0.0	13594.15
COST CENTER LINTER STORAGE BUILDING	13.20	3000	3960.00	891.00	3149.53	396.00	554.40	237.60		5228.52
TOTAL COST				891.00	3149.53	396.00	554.40	237.60	0.0	5228.52
TOTAL FIXED COSTS				130416.13	338556.50	23376.45	60263.13	25797.04	204500.00	783309.31

Section C TOTAL REVENUE AT 100% CAPACITY UTILIZATION

REVENUE FROM OIL SALES	2953086.00
REVENUE FROM MEAL SALES	2208588.00
REVENUE FROM HULL SALES	286970.88
REVENUE FROM LINTER SALES	467939.69
TOTAL REVENUE	5921583.00

Section D TOTAL VARIABLE COSTS BY ITEM BY COST CENTER

UTILIZATION LEVEL	100%	90%	80%	70%	60%	50%	40%	30%	20%	10%
SEED PROCESSED	3300.	29700.	26400.	23100.	19800.	16500.	13200.	9900.	6600.	3300.
PROCESSING DAYS	330.	297.	264.	231.	198.	165.	132.	99.	66.	33.
COTTONSEED BUY										
COTTONSEED COST	3923339.	3520725.	3124431.	2746127.	2353824.	1961520.	1569216.	1176912.	784609.	3923305.
INT. OPER. CAP.	266014.	215471.	170249.	130347.	95765.	66504.	42562.	23941.	10641.	2660.
TOTAL COTTONSEED COST	4189353.	3736196.	3306679.	2876473.	2449589.	2028023.	1611778.	1200853.	795249.	394965.
COST CENTER OFFICE										
ELECTRICITY	42.	42.	42.	42.	42.	42.	42.	42.	42.	42.
LAB ANALYSIS	8250.	7250.	6600.	5775.	4950.	4125.	3300.	2475.	1650.	825.
MISCELLANEOUS	51150.	46035.	40920.	35805.	30690.	25575.	20460.	15345.	10230.	5115.
TOTAL LESS INTEREST	59442.	53902.	47962.	41622.	35682.	29742.	23802.	17862.	11922.	5982.
INT. OPER. CAP.	523.	502.	397.	304.	223.	155.	99.	56.	25.	6.
TOTAL P.S. COST	60062.	54004.	47959.	41926.	35905.	29857.	23901.	17918.	11947.	5988.
COST CENTER UNLOADING										
LABOR	12852.	11567.	10282.	8996.	7711.	6426.	5141.	3856.	2570.	1285.
ELECTRICITY	1234.	1110.	987.	864.	741.	618.	495.	372.	249.	123.
REPAIRS	4791.	4312.	3833.	3354.	2875.	2396.	1916.	1437.	958.	479.
TOTAL LESS INTEREST	18976.	16989.	15102.	13214.	11327.	9440.	7552.	5665.	3778.	1890.
INT. OPER. CAP.	197.	163.	126.	96.	71.	49.	32.	18.	8.	2.
TOTAL P.S. COST	19073.	17148.	15228.	13311.	11398.	9489.	7594.	5633.	3785.	1892.
COST CENTER SEED STORAGE										
LABOR	3534.	3149.	28274.	24740.	21206.	17671.	14137.	10603.	7069.	3534.
ELECTRICITY	5545.	4991.	4438.	3884.	3330.	2777.	2223.	1669.	1116.	562.
REPAIRS	1437.	12936.	11489.	10061.	8624.	7187.	5749.	4312.	2875.	1437.
INSURANCE	1961.	1769.	1569.	1373.	1176.	980.	784.	588.	392.	196.
TOTAL LESS INTEREST	57222.	51501.	45780.	40058.	34337.	28615.	22894.	17173.	11451.	5730.
INT. OPER. CAP.	597.	484.	382.	293.	215.	149.	96.	54.	24.	6.
TOTAL P.S. COST	57819.	51485.	46162.	40351.	34552.	28765.	22990.	17226.	11475.	5736.
COST CENTER CLEANING										
LABOR	21206.	19385.	16965.	14844.	12723.	10603.	8482.	6362.	4241.	2121.
ELECTRICITY	14763.	13291.	11815.	10338.	8862.	7385.	5909.	4432.	2956.	1479.
REPAIRS	4791.	4312.	3833.	3354.	2875.	2396.	1916.	1437.	958.	479.
TOTAL LESS INTEREST	40765.	36688.	32612.	28536.	24460.	20384.	16308.	12231.	8155.	4079.
INT. OPER. CAP.	429.	344.	272.	208.	153.	106.	68.	38.	17.	4.
TOTAL P.S. COST	41190.	37033.	32884.	28744.	24613.	20490.	16376.	12270.	8172.	4083.
COST CENTER DELINTEERING										
LABOR	97729.	89429.	80128.	70823.	60523.	51228.	41928.	32628.	23328.	14028.
ELECTRICITY	154765.	139291.	123814.	108344.	92871.	77397.	61923.	46450.	30976.	15503.
REPAIRS	50211.	45190.	40169.	35148.	30127.	25106.	20085.	15063.	10042.	5021.
MISCELLANEOUS	9900.	8910.	7920.	6930.	5940.	4950.	3960.	2970.	1980.	990.
TOTAL LESS INTEREST	312605.	286420.	251035.	215250.	179466.	143681.	107896.	72112.	46327.	20542.
INT. OPER. CAP.	3261.	2693.	2179.	1718.	1311.	958.	659.	413.	222.	84.
TOTAL P.S. COST	315866.	289513.	263214.	236968.	210777.	184639.	158555.	132525.	106549.	80626.
COST CENTER BALING										
LABOR	15637.	15337.	15637.	15637.	15637.	15637.	15637.	15637.	15637.	15637.
ELECTRICITY	22151.	19937.	17722.	15507.	13293.	11078.	8863.	6648.	4434.	2219.
REPAIRS	7187.	6468.	5749.	5031.	4312.	3593.	2875.	2156.	1437.	719.
BAGGING-TIES	24929.	22426.	19943.	17450.	14957.	12464.	9972.	7479.	4986.	2493.
TOTAL LESS INTEREST	69909.	64777.	59651.	54525.	48400.	42272.	37346.	31922.	26493.	21067.
INT. OPER. CAP.	729.	595.	463.	329.	202.	123.	75.	47.	28.	13.
TOTAL P.S. COST	70633.	65083.	60544.	56005.	51466.	46927.	42392.	37847.	33302.	28754.
COST CENTER MULLING-SEPARATION										
LABOR	12959.	11663.	10367.	9071.	7775.	6480.	5184.	3888.	2592.	1296.
ELECTRICITY	2954.	2658.	2363.	2068.	1772.	1477.	1182.	886.	591.	296.
REPAIRS	953.	862.	767.	671.	575.	479.	383.	287.	192.	96.
TOTAL LESS INTEREST	16871.	15184.	13497.	11810.	10123.	8436.	6749.	5062.	3375.	1688.
INT. OPER. CAP.	176.	143.	113.	86.	63.	44.	29.	16.	7.	2.
TOTAL P.S. COST	17047.	15226.	13609.	11896.	10186.	8480.	6777.	5077.	3382.	1689.
COST CENTER MEATS CONDITIONING										
LABOR	12959.	11663.	10367.	9071.	7775.	6480.	5184.	3888.	2592.	1296.
FUEL	115500.	103950.	92400.	80850.	69300.	57750.	46200.	34650.	23100.	11550.
TOTAL LESS INTEREST	128459.	115613.	102767.	89921.	77075.	64230.	51384.	38538.	25692.	12846.
INT. OPER. CAP.	1340.	1085.	858.	657.	482.	335.	214.	121.	64.	13.
TOTAL P.S. COST	129799.	116699.	103625.	90578.	77558.	64565.	51598.	38658.	25745.	12859.
COST CENTER EXTRACTION										
LABOR	86572.	79739.	72906.	66074.	59241.	52408.	45575.	38742.	31909.	25076.
ELECTRICITY	95399.	85461.	76323.	67185.	57247.	47708.	38170.	28632.	19094.	9556.
REPAIRS	30951.	27456.	24761.	21666.	18571.	15475.	12380.	9285.	6190.	3095.
WATER	89135.	80258.	71381.	62504.	53627.	44750.	35873.	26996.	18119.	9242.
TOTAL LESS INTEREST	302057.	273714.	245371.	217028.	188685.	160341.	131998.	103655.	75312.	46969.
INT. OPER. CAP.	3151.	2570.	2048.	1585.	1181.	836.	551.	324.	157.	49.
TOTAL P.S. COST	305208.	276284.	247419.	218613.	189366.	161178.	132549.	103980.	75469.	47018.
COST CENTER OIL STORAGE										
LABOR	11781.	10603.	9425.	8247.	7069.	5890.	4712.	3534.	2356.	1178.
ELECTRICITY	247.	223.	199.	173.	149.	124.	100.	75.	50.	26.
REPAIRS	1516.	1375.	1233.	1092.	950.	808.	667.	525.	393.	192.
INSURANCE	1873.	1720.	1579.	1438.	1297.	1156.	1015.	874.	733.	592.
TOTAL LESS INTEREST	15418.	13876.	12334.	10793.	9251.	7709.	6168.	4626.	3084.	1543.
INT. OPER. CAP.	161.	130.	103.	79.	53.	40.	26.	14.	6.	2.
TOTAL P.S. COST	15579.	14006.	12437.	10872.	9309.	7750.	6194.	4641.	3051.	1544.
COST CENTER MEAL STORAGE										
LABOR	5890.	5301.	4712.	4123.	3534.	2945.	2356.	1767.	1178.	589.
ELECTRICITY	739.	666.	592.	518.	444.	370.	296.	223.	149.	75.
REPAIRS	1916.	1725.	1533.	1342.	1150.	958.	767.	575.	383.	192.
INSURANCE	1100.	990.	880.	770.	660.	550.	440.	330.	220.	110.
TOTAL LESS INTEREST	9646.	8882.	7717.	6753.	5788.	4824.	3859.	2895.	1930.	966.
INT. OPER. CAP.	101.	82.	64.	49.	36.	25.	16.	9.	4.	1.
TOTAL P.S. COST	9747.	8763.	7782.	6802.	5824.	4849.	3875.	2904.	1934.	967.

COST CENTER HULL STORAGE										
LABOR	0.18	0.18	0.18	0.18	0.18	0.18	0.18	0.18	0.18	0.18
ELECTRICITY	0.03	0.03	0.03	0.03	0.03	0.03	0.03	0.03	0.03	0.03
REPAIRS	0.09	0.09	0.09	0.09	0.09	0.09	0.09	0.09	0.09	0.09
INSURANCE	0.00	0.00	0.00	0.00	0.00	0.00	0.00	0.00	0.00	0.00
INT. OPER. CAP.	0.00	0.00	0.00	0.00	0.00	0.00	0.00	0.00	0.00	0.00
AVER. P.S. COST	0.31	0.31	0.31	0.31	0.31	0.31	0.31	0.31	0.31	0.31

COST CENTER LINTER STORAGE										
LABOR	0.29	0.29	0.29	0.29	0.29	0.29	0.29	0.29	0.29	0.29
ELECTRICITY	0.00	0.00	0.00	0.00	0.00	0.00	0.00	0.00	0.00	0.00
REPAIRS	0.01	0.01	0.01	0.01	0.01	0.01	0.01	0.01	0.01	0.01
INSURANCE	0.01	0.01	0.01	0.01	0.01	0.01	0.01	0.01	0.01	0.01
INT. OPER. CAP.	0.00	0.00	0.00	0.00	0.00	0.00	0.00	0.00	0.00	0.00
AVER. P.S. COST	0.31	0.31	0.31	0.31	0.31	0.31	0.31	0.31	0.31	0.31

Section F AVERAGE VARIABLE COST BY RESOURCE ITEM PROCESSFD

LABOR	9.95	10.25	10.62	11.10	11.74	12.63	13.97	16.21	20.69	36.11
ELECTRICITY	9.06	9.06	9.06	9.06	9.06	9.06	9.06	9.06	9.06	9.06
REPAIRS	3.65	3.65	3.65	3.65	3.65	3.65	3.65	3.65	3.65	3.65
LAB ANALYSIS	0.25	0.25	0.25	0.25	0.25	0.25	0.25	0.25	0.25	0.25
BAGGING-TIES	3.76	3.76	3.76	3.76	3.76	3.76	3.76	3.76	3.76	3.76
FUEL	3.50	3.50	3.50	3.50	3.50	3.50	3.50	3.50	3.50	3.50
MISCELLANEOUS	1.85	1.85	1.85	1.85	1.85	1.85	1.85	1.85	1.85	1.85
SOLVENT	0.0	0.0	0.0	0.0	0.0	0.0	0.0	0.0	0.0	0.0
INSURANCE	0.15	0.15	0.15	0.15	0.15	0.15	0.15	0.15	0.15	0.15
WATER	2.70	2.70	2.70	2.71	2.71	2.71	2.72	2.73	2.75	2.80

Section G COST CENTER AVERAGE FIXED COSTS

UTILIZATION LEVEL	100.0	90.0	80.0	70.0	60.0	50.0	40.0	30.0	20.0	10.0
OFFICE	6.44	7.60	8.55	9.77	11.40	13.68	17.10	22.80	34.20	68.40
UNLOADING	0.75	0.83	0.93	1.07	1.24	1.49	1.87	2.49	3.73	7.47
SEED STORAGE	4.20	4.67	5.25	6.00	7.00	8.40	10.50	14.01	21.01	42.02
CLEANING	0.62	0.68	0.77	0.89	1.03	1.22	1.54	2.05	3.08	6.15
DELINTEHING	2.72	3.03	3.40	3.89	4.54	5.45	6.81	9.08	13.62	27.24
BALING	1.05	1.17	1.31	1.50	1.75	2.10	2.63	3.51	5.26	10.52
HULLING-SEPARATION	1.02	1.14	1.28	1.46	1.70	2.04	2.55	3.41	5.11	10.22
MEATS CONDITIONING	2.30	2.55	2.87	3.28	3.83	4.63	5.75	7.66	11.49	22.99
EXTRACTION	3.12	3.47	3.90	4.46	5.20	6.24	7.80	10.40	15.60	31.20
OIL STORAGE	0.38	0.42	0.48	0.54	0.63	0.76	0.95	1.27	1.90	3.80
MEAL STORAGE	0.17	0.19	0.21	0.24	0.28	0.33	0.42	0.55	0.83	1.66
HULL STORAGE	0.41	0.46	0.51	0.59	0.69	0.82	1.03	1.37	2.06	4.12
LINTER STORAGE	0.16	0.19	0.20	0.23	0.26	0.32	0.40	0.53	0.79	1.58

Section H COST CENTER AVERAGE VARIABLE COSTS

UTILIZATION LEVEL	100.0	90.0	80.0	70.0	60.0	50.0	40.0	30.0	20.0	10.0
OFFICE	1.82	1.82	1.82	1.81	1.81	1.81	1.81	1.81	1.81	1.81
UNLOADING	0.58	0.58	0.58	0.58	0.58	0.58	0.57	0.57	0.57	0.57
SEED STORAGE	1.75	1.75	1.75	1.75	1.75	1.74	1.74	1.74	1.74	1.74
CLEANING	1.25	1.25	1.25	1.24	1.24	1.24	1.24	1.24	1.24	1.24
DELINTEHING	9.57	9.75	9.97	10.26	10.65	11.19	12.01	13.39	16.14	24.43
BALING	2.14	2.15	2.26	2.34	2.45	2.61	2.84	3.23	4.02	6.39
HULLING-SEPARATION	0.92	0.92	0.92	0.91	0.91	0.91	0.91	0.91	0.91	0.91
MEATS CONDITIONING	3.93	3.93	3.93	3.92	3.92	3.91	3.91	3.90	3.90	3.90
EXTRACTION	9.25	9.30	9.37	9.46	9.59	9.77	10.04	10.50	11.43	14.25
OIL STORAGE	0.47	0.47	0.47	0.47	0.47	0.47	0.47	0.47	0.47	0.47
MEAL STORAGE	0.30	0.30	0.29	0.29	0.29	0.29	0.29	0.29	0.29	0.29
HULL STORAGE	0.31	0.31	0.31	0.31	0.31	0.31	0.31	0.31	0.31	0.31
LINTER STORAGE	0.31	0.31	0.31	0.31	0.31	0.31	0.31	0.31	0.31	0.31

Section I COST CENTER AVERAGE TOTAL COSTS

UTILIZATION LEVEL	100.0	90.0	80.0	70.0	60.0	50.0	40.0	30.0	20.0	10.0
OFFICE	3.06	9.42	10.37	11.59	13.21	15.49	18.91	24.61	36.01	70.21
UNLOADING	1.32	1.41	1.51	1.64	1.82	2.07	2.44	3.06	4.31	8.04
SEED STORAGE	5.95	6.42	7.00	7.75	8.79	10.15	12.25	15.75	22.75	43.76
CLEANING	1.86	1.93	2.01	2.12	2.27	2.47	2.78	3.25	4.31	7.39
DELINTEHING	12.30	12.77	13.37	14.15	15.18	16.64	18.82	22.47	29.76	51.67
BALING	3.19	3.26	3.57	3.84	4.20	4.71	5.47	6.74	9.28	16.91
HULLING-SEPARATION	1.54	1.65	1.79	1.97	2.22	2.56	3.07	3.92	5.62	10.73
MEATS CONDITIONING	6.23	6.48	6.80	7.21	7.75	8.51	9.66	11.57	15.39	26.88
EXTRACTION	12.37	12.77	13.27	13.92	14.79	16.01	17.84	20.90	27.03	45.44
OIL STORAGE	0.45	0.49	0.55	0.61	0.70	0.83	1.02	1.37	2.06	4.27
MEAL STORAGE	0.46	0.48	0.50	0.53	0.57	0.63	0.71	0.85	1.12	1.96
HULL STORAGE	0.72	0.76	0.82	0.89	0.99	1.13	1.33	1.68	2.36	4.42
LINTER STORAGE	0.47	0.49	0.51	0.54	0.57	0.63	0.70	0.84	1.10	1.89

Section J TOTAL COSTS AND RETURNS MATRIX

UTILIZATION LEVEL	100.0	90.0	80.0	70.0	60.0	50.0	40.0	30.0	20.0	10.0
TOTAL FIXED COST	783309.									
TOTAL VAR. COST	5251437.	4710355.	4174793.	3644755.	3120241.	2601244.	2087770.	1579814.	1077386.	580476.
TOTAL COST	6034746.	5481649.	4991102.	4428064.	3902550.	3384533.	2871079.	2363123.	1860995.	1363785.
TOTAL REVENUE	5921583.	5329424.	4727266.	4145108.	3552953.	2963792.	2368634.	1776476.	1184318.	592160.
TOTAL NET REVENUE	-113163.	-164240.	-220836.	-282956.	-350600.	-423761.	-502445.	-586647.	-676377.	-771625.

Section K AVERAGE COST AND RETURNS MATRIX

UTILIZATION LEVEL	100.0	90.0	80.0	70.0	60.0	50.0	40.0	30.0	20.0	10.0
AVER. FIXED COST	23.74	26.37	29.67	33.91	39.56	47.47	59.34	74.12	118.68	237.37
AVER. VAR. COST	159.13	159.40	158.14	157.78	157.99	157.65	158.16	158.58	163.24	175.90
AVER. TOTAL COST	182.87	186.47	187.81	191.69	197.15	205.12	217.51	238.70	281.92	413.27
AVER. REVENUE	179.44	179.44	179.44	179.44	179.44	179.44	179.44	179.44	179.44	179.44
AVER. NET REVENUE	-3.43	-5.53	-8.36	-12.25	-17.71	-25.68	-38.06	-59.26	-102.48	-233.83